

P-660H/HW-D Series

ADSL2+ 4-port Gateway

User's Guide

Version 3.40

Edition 1

7/2006

The logo for ZyXEL, featuring the word "ZyXEL" in a bold, blue, sans-serif font. The "Zy" is lowercase and the "XEL" is uppercase. The letters are slightly italicized and have a modern, clean design.

Copyright

Copyright © 2006 by ZyXEL Communications Corporation.

The contents of this publication may not be reproduced in any part or as a whole, transcribed, stored in a retrieval system, translated into any language, or transmitted in any form or by any means, electronic, mechanical, magnetic, optical, chemical, photocopying, manual, or otherwise, without the prior written permission of ZyXEL Communications Corporation.

Published by ZyXEL Communications Corporation. All rights reserved.

Disclaimer

ZyXEL does not assume any liability arising out of the application or use of any products, or software described herein. Neither does it convey any license under its patent rights nor the patent rights of others. ZyXEL further reserves the right to make changes in any products described herein without notice. This publication is subject to change without notice.

Trademarks

ZyNOS (ZyXEL Network Operating System) is a registered trademark of ZyXEL Communications, Inc. Other trademarks mentioned in this publication are used for identification purposes only and may be properties of their respective owners.

Certifications

Federal Communications Commission (FCC) Interference Statement

The device complies with Part 15 of FCC rules. Operation is subject to the following two conditions:

- This device may not cause harmful interference.
- This device must accept any interference received, including interference that may cause undesired operations.

This device has been tested and found to comply with the limits for a Class B digital device pursuant to Part 15 of the FCC Rules. These limits are designed to provide reasonable protection against harmful interference in a commercial environment. This device generates, uses, and can radiate radio frequency energy, and if not installed and used in accordance with the instructions, may cause harmful interference to radio communications.

If this device does cause harmful interference to radio/television reception, which can be determined by turning the device off and on, the user is encouraged to try to correct the interference by one or more of the following measures:

- 1 Reorient or relocate the receiving antenna.
- 2 Increase the separation between the equipment and the receiver.
- 3 Connect the equipment into an outlet on a circuit different from that to which the receiver is connected.
- 4 Consult the dealer or an experienced radio/TV technician for help.

FCC Radiation Exposure Statement

- The device complies with FCC RF radiation exposure limits set forth for an uncontrolled environment, under 47 CFR 2.1093 paragraph (d)(2). End users must follow the specific operating instructions for satisfying RF exposure compliance.
- This transmitter must not be co-located or operating in conjunction with any other antenna or transmitter.
- To comply with FCC RF exposure compliance requirements, a separation distance of at least 20 cm must be maintained between the antenna of this device and all persons.

注意！

依據 低功率電波輻射性電機管理辦法

第十二條 經型式認證合格之低功率射頻電機，非經許可，公司、商號或使用者均不得擅自變更頻率、加大功率或變更原設計之特性及功能。

第十四條 低功率射頻電機之使用不得影響飛航安全及干擾合法通信；經發現有干擾現象時，應立即停用，並改善至無干擾時方得繼續使用。

前項合法通信，指依電信規定作業之無線電信。低功率射頻電機須忍

受合法通信或工業、科學及醫療用電波輻射性電機設備之干擾。

Notices

Changes or modifications not expressly approved by the party responsible for compliance could void the user's authority to operate the equipment.

This Class B digital apparatus complies with Canadian ICES-003.

Cet appareil numérique de la classe B est conforme à la norme NMB-003 du Canada.

Viewing Certifications

- 1 Go to <http://www.zyxel.com>.
- 2 Select your product from the drop-down list box on the ZyXEL home page to go to that product's page.
- 3 Select the certification you wish to view from this page.

Safety Warnings

For your safety, be sure to read and follow all warning notices and instructions.

- Do NOT use this product near water, for example, in a wet basement or near a swimming pool.
- Do NOT expose your device to dampness, dust or corrosive liquids.
- Do NOT store things on the device.
- Do NOT install, use, or service this device during a thunderstorm. There is a remote risk of electric shock from lightning.
- Connect ONLY suitable accessories to the device.
- Do NOT open the device or unit. Opening or removing covers can expose you to dangerous high voltage points or other risks. ONLY qualified service personnel should service or disassemble this device. Please contact your vendor for further information.
- ONLY qualified service personnel should service or disassemble this device.
- Make sure to connect the cables to the correct ports.
- Place connecting cables carefully so that no one will step on them or stumble over them.
- Always disconnect all cables from this device before servicing or disassembling.
- Use ONLY an appropriate power adaptor or cord for your device.
- Connect the power adaptor or cord to the right supply voltage (for example, 110V AC in North America or 230V AC in Europe).
- Do NOT allow anything to rest on the power adaptor or cord and do NOT place the product where anyone can walk on the power adaptor or cord.
- Do NOT use the device if the power adaptor or cord is damaged as it might cause electrocution.
- If the power adaptor or cord is damaged, remove it from the power outlet.
- Do NOT attempt to repair the power adaptor or cord. Contact your local vendor to order a new one.
- Do not use the device outside, and make sure all the connections are indoors. There is a remote risk of electric shock from lightning.
- Use only No. 26 AWG (American Wire Gauge) or larger telephone wire.
- Antenna Warning! This device meets ETSI and FCC certification requirements when using the included antenna(s). Only use the included antenna(s).
- If you wall mount your device, make sure that no electrical lines, gas or water pipes will be damaged.

This product is recyclable. Dispose of it properly.

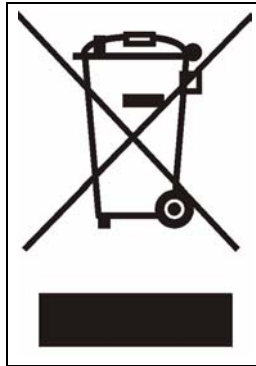

ZyXEL Limited Warranty

ZyXEL warrants to the original end user (purchaser) that this product is free from any defects in materials or workmanship for a period of up to two years from the date of purchase. During the warranty period, and upon proof of purchase, should the product have indications of failure due to faulty workmanship and/or materials, ZyXEL will, at its discretion, repair or replace the defective products or components without charge for either parts or labor, and to whatever extent it shall deem necessary to restore the product or components to proper operating condition. Any replacement will consist of a new or re-manufactured functionally equivalent product of equal or higher value, and will be solely at the discretion of ZyXEL. This warranty shall not apply if the product has been modified, misused, tampered with, damaged by an act of God, or subjected to abnormal working conditions.

Note

Repair or replacement, as provided under this warranty, is the exclusive remedy of the purchaser. This warranty is in lieu of all other warranties, express or implied, including any implied warranty of merchantability or fitness for a particular use or purpose. ZyXEL shall in no event be held liable for indirect or consequential damages of any kind to the purchaser.

To obtain the services of this warranty, contact ZyXEL's Service Center for your Return Material Authorization number (RMA). Products must be returned Postage Prepaid. It is recommended that the unit be insured when shipped. Any returned products without proof of purchase or those with an out-dated warranty will be repaired or replaced (at the discretion of ZyXEL) and the customer will be billed for parts and labor. All repaired or replaced products will be shipped by ZyXEL to the corresponding return address, Postage Paid. This warranty gives you specific legal rights, and you may also have other rights that vary from country to country.

Registration

Register your product online to receive e-mail notices of firmware upgrades and information at www.zyxel.com for global products, or at www.us.zyxel.com for North American products.

Customer Support

Please have the following information ready when you contact customer support.

- Product model and serial number.
- Warranty Information.
- Date that you received your device.
- Brief description of the problem and the steps you took to solve it.

METHOD	SUPPORT E-MAIL	TELEPHONE	WEB SITE	REGULAR MAIL
LOCATION	SALES E-MAIL	FAX	FTP SITE	
CORPORATE HEADQUARTERS (WORLDWIDE)	support@zyxel.com.tw	+886-3-578-3942	www.zyxel.com www.europe.zyxel.com	ZyXEL Communications Corp. 6 Innovation Road II Science Park Hsinchu 300 Taiwan
	sales@zyxel.com.tw	+886-3-578-2439	ftp.zyxel.com ftp.europe.zyxel.com	
COSTA RICA	soporte@zyxel.co.cr	+506-2017878	www.zyxel.co.cr	ZyXEL Costa Rica Plaza Roble Escazú Etapa El Patio, Tercer Piso San José, Costa Rica
	sales@zyxel.co.cr	+506-2015098	ftp.zyxel.co.cr	
CZECH REPUBLIC	info@cz.zyxel.com	+420-241-091-350	www.zyxel.cz	ZyXEL Communications Czech s.r.o. Modranská 621 143 01 Praha 4 - Modrany Ceská Republika
	info@cz.zyxel.com	+420-241-091-359		
DENMARK	support@zyxel.dk	+45-39-55-07-00	www.zyxel.dk	ZyXEL Communications A/S Columbusvej 2860 Soeborg Denmark
	sales@zyxel.dk	+45-39-55-07-07		
FINLAND	support@zyxel.fi	+358-9-4780-8411	www.zyxel.fi	ZyXEL Communications Oy Malminkaari 10 00700 Helsinki Finland
	sales@zyxel.fi	+358-9-4780 8448		
FRANCE	info@zyxel.fr	+33-4-72-52-97-97	www.zyxel.fr	ZyXEL France 1 rue des Vergers Bat. 1 / C 69760 Limonest France
		+33-4-72-52-19-20		
GERMANY	support@zyxel.de	+49-2405-6909-0	www.zyxel.de	ZyXEL Deutschland GmbH. Adenauerstr. 20/A2 D-52146 Wuerselen Germany
	sales@zyxel.de	+49-2405-6909-99		
HUNGARY	support@zyxel.hu	+36-1-3361649	www.zyxel.hu	ZyXEL Hungary 48, Zoldomb Str. H-1025, Budapest Hungary
	info@zyxel.hu	+36-1-3259100		
KAZAKHSTAN	http://zyxel.kz/support	+7-3272-590-698	www.zyxel.kz	ZyXEL Kazakhstan 43, Dostyk ave., Office 414 Dostyk Business Centre 050010, Almaty Republic of Kazakhstan
	sales@zyxel.kz	+7-3272-590-689		
NORTH AMERICA	support@zyxel.com	1-800-255-4101 +1-714-632-0882	www.us.zyxel.com	ZyXEL Communications Inc. 1130 N. Miller St. Anaheim CA 92806-2001 U.S.A.
	sales@zyxel.com	+1-714-632-0858	ftp.us.zyxel.com	

METHOD	SUPPORT E-MAIL	TELEPHONE	WEB SITE	REGULAR MAIL
	SALES E-MAIL	FAX	FTP SITE	
NORWAY	support@zyxel.no	+47-22-80-61-80	www.zyxel.no	ZyXEL Communications A/S Niils Hansens vei 13 0667 Oslo Norway
	sales@zyxel.no	+47-22-80-61-81		
POLAND	info@pl.zyxel.com	+48 (22) 333 8250	www.pl.zyxel.com	ZyXEL Communications ul. Okrzei 1A 03-715 Warszawa Poland
		+48 (22) 333 8251		
RUSSIA	http://zyxel.ru/support	+7-095-542-89-29	www.zyxel.ru	ZyXEL Russia Ostrovityanova 37a Str. Moscow, 117279 Russia
	sales@zyxel.ru	+7-095-542-89-25		
SPAIN	support@zyxel.es	+34-902-195-420	www.zyxel.es	ZyXEL Communications Arte, 21 5ª planta 28033 Madrid Spain
	sales@zyxel.es	+34-913-005-345		
SWEDEN	support@zyxel.se	+46-31-744-7700	www.zyxel.se	ZyXEL Communications A/S Sjöporten 4, 41764 Göteborg Sweden
	sales@zyxel.se	+46-31-744-7701		
UKRAINE	support@ua.zyxel.com	+380-44-247-69-78	www.ua.zyxel.com	ZyXEL Ukraine 13, Pimonenko Str. Kiev, 04050 Ukraine
	sales@ua.zyxel.com	+380-44-494-49-32		
UNITED KINGDOM	support@zyxel.co.uk	+44-1344 303044 08707 555779 (UK only)	www.zyxel.co.uk	ZyXEL Communications UK Ltd., 11 The Courtyard, Eastern Road, Bracknell, Berkshire, RG12 2XB, United Kingdom (UK)
	sales@zyxel.co.uk	+44-1344 303034	ftp.zyxel.co.uk	

+” is the (prefix) number you enter to make an international telephone call.

Table of Contents

Copyright	2
Certifications	3
Safety Warnings	5
ZyXEL Limited Warranty	7
Customer Support	8
Table of Contents	10
List of Figures	22
List of Tables	28
Preface	32
Chapter 1	
Getting To Know Your ZyXEL Device	34
1.1 Introducing the ZyXEL Device	34
1.2 Features	35
1.2.1 Wireless Features (P-660HW-D Only)	37
1.3 Applications for the ZyXEL Device	38
1.3.1 Protected Internet Access	39
1.3.2 LAN to LAN Application	39
1.4 Front Panel LEDs	39
1.5 Hardware Connection	41
Chapter 2	
Introducing the Web Configurator	42
2.1 Web Configurator Overview	42
2.2 Accessing the Web Configurator	42
2.3 Resetting the ZyXEL Device	44
2.3.1 Using the Reset Button	44
2.4 Navigating the Web Configurator	44
2.4.1 Navigation Panel	44
2.4.2 Status Screen	47
2.4.3 Status: Any IP Table	50
2.4.4 Status: WLAN Status	50
2.4.5 Status: Bandwidth Status	51

2.4.6 Status: Packet Statistics	52
2.4.7 Changing Login Password	53
Chapter 3	
Wizard Setup for Internet Access	56
3.1 Introduction	56
3.2 Internet Access Wizard Setup	56
3.2.1 Automatic Detection	58
3.2.2 Manual Configuration	58
3.3 Wireless Connection Wizard Setup	63
3.3.1 Manually assign a WPA-PSK key	66
3.3.2 Manually assign a WEP key	67
Chapter 4	
Bandwidth Management Wizard	70
4.1 Introduction	70
4.2 Predefined Media Bandwidth Management Services	70
4.3 Bandwidth Management Wizard Setup	71
Chapter 5	
WAN Setup	76
5.1 WAN Overview	76
5.1.1 Encapsulation	76
5.1.1.1 ENET ENCAP	76
5.1.1.2 PPP over Ethernet	76
5.1.1.3 PPPoA	77
5.1.1.4 RFC 1483	77
5.1.2 Multiplexing	77
5.1.2.1 VC-based Multiplexing	77
5.1.2.2 LLC-based Multiplexing	77
5.1.3 Encapsulation and Multiplexing Scenarios	77
5.1.3.1 Scenario 1: One VC, Multiple Protocols	78
5.1.3.2 Scenario 2: One VC, One Protocol (IP)	78
5.1.3.3 Scenario 3: Multiple VCs	78
5.1.4 VPI and VCI	78
5.1.5 IP Address Assignment	78
5.1.5.1 IP Assignment with PPPoA or PPPoE Encapsulation	78
5.1.5.2 IP Assignment with RFC 1483 Encapsulation	78
5.1.5.3 IP Assignment with ENET ENCAP Encapsulation	79
5.1.6 Nailed-Up Connection (PPP)	79
5.1.7 NAT	79
5.2 Metric	79
5.3 Traffic Shaping	80

5.3.1 ATM Traffic Classes	81
5.3.1.1 Constant Bit Rate (CBR)	81
5.3.1.2 Variable Bit Rate (VBR)	81
5.3.1.3 Unspecified Bit Rate (UBR)	81
5.4 Zero Configuration Internet Access	81
5.5 Internet Connection	82
5.5.1 Configuring Advanced Internet Connection Setup	84
5.6 Configuring More Connections	85
5.6.1 More Connections Edit	86
5.6.2 Configuring More Connections Advanced Setup	89
5.7 Traffic Redirect	90
5.8 Configuring WAN Backup	91
Chapter 6	
LAN Setup	94
6.1 LAN Overview	94
6.1.1 LANs, WANs and the ZyXEL Device	94
6.1.2 DHCP Setup	95
6.1.2.1 IP Pool Setup	95
6.1.3 DNS Server Address	95
6.1.4 DNS Server Address Assignment	96
6.2 LAN TCP/IP	96
6.2.1 IP Address and Subnet Mask	96
6.2.1.1 Private IP Addresses	97
6.2.2 RIP Setup	97
6.2.3 Multicast	98
6.2.4 Any IP	98
6.2.4.1 How Any IP Works	99
6.3 Configuring LAN IP	100
6.3.1 Configuring Advanced LAN Setup	100
6.4 DHCP Setup	102
6.5 LAN Client List	103
6.6 LAN IP Alias	104
Chapter 7	
Wireless LAN	108
7.1 Wireless Network Overview	108
7.2 Wireless Security Overview	109
7.2.1 SSID	109
7.2.2 MAC Address Filter	109
7.2.3 User Authentication	110
7.2.4 Encryption	110
7.2.5 One-Touch Intelligent Security Technology (OTIST)	111

7.3 Wireless Performance Overview	111
7.3.1 Quality of Service (QoS)	111
7.4 General Wireless LAN Screen	112
7.4.1 No Security	113
7.4.2 WEP Encryption	114
7.4.3 WPA-PSK/WPA2-PSK	115
7.4.4 WPA/WPA2	116
7.4.5 Wireless LAN Advanced Setup	119
7.5 OTIST	120
7.5.1 Enabling OTIST	120
7.5.1.1 AP	121
7.5.1.2 Wireless Client	122
7.5.2 Starting OTIST	123
7.5.3 Notes on OTIST	123
7.6 MAC Filter	124
7.7 WMM QoS	126
7.7.1 WMM QoS Example	126
7.7.2 WMM QoS Priorities	126
7.7.3 Services	127
7.8 QoS Screen	128
7.8.1 ToS (Type of Service) and WMM QoS	129
7.8.2 Application Priority Configuration	130

Chapter 8

Network Address Translation (NAT) Screens 132

8.1 NAT Overview	132
8.1.1 NAT Definitions	132
8.1.2 What NAT Does	133
8.1.3 How NAT Works	133
8.1.4 NAT Application	134
8.1.5 NAT Mapping Types	134
8.2 SUA (Single User Account) Versus NAT	135
8.3 NAT General Setup	135
8.4 Port Forwarding	136
8.4.1 Default Server IP Address	137
8.4.2 Port Forwarding: Services and Port Numbers	137
8.4.3 Configuring Servers Behind Port Forwarding (Example)	137
8.5 Configuring Port Forwarding	138
8.5.1 Port Forwarding Rule Edit	139
8.6 Address Mapping	140
8.6.1 Address Mapping Rule Edit	142

Chapter 9	
Firewalls	144
9.1 Firewall Overview	144
9.2 Types of Firewalls	144
9.2.1 Packet Filtering Firewalls	144
9.2.2 Application-level Firewalls	145
9.2.3 Stateful Inspection Firewalls	145
9.3 Introduction to ZyXEL's Firewall	145
9.3.1 Denial of Service Attacks	146
9.4 Denial of Service	146
9.4.1 Basics	146
9.4.2 Types of DoS Attacks	147
9.4.2.1 ICMP Vulnerability	149
9.4.2.2 Illegal Commands (NetBIOS and SMTP)	149
9.4.2.3 Traceroute	150
9.5 Stateful Inspection	150
9.5.1 Stateful Inspection Process	151
9.5.2 Stateful Inspection and the ZyXEL Device	151
9.5.3 TCP Security	152
9.5.4 UDP/ICMP Security	152
9.5.5 Upper Layer Protocols	153
9.6 Guidelines for Enhancing Security with Your Firewall	153
9.6.1 Security In General	153
9.7 Packet Filtering Vs Firewall	154
9.7.1 Packet Filtering:	154
9.7.1.1 When To Use Filtering	155
9.7.2 Firewall	155
9.7.2.1 When To Use The Firewall	155
Chapter 10	
Firewall Configuration	156
10.1 Access Methods	156
10.2 Firewall Policies Overview	156
10.3 Rule Logic Overview	157
10.3.1 Rule Checklist	157
10.3.2 Security Ramifications	157
10.3.3 Key Fields For Configuring Rules	158
10.3.3.1 Action	158
10.3.3.2 Service	158
10.3.3.3 Source Address	158
10.3.3.4 Destination Address	158
10.4 Connection Direction	158
10.4.1 LAN to WAN Rules	159

10.4.2 Alerts	159
10.5 General Firewall Policy	159
10.6 Firewall Rules Summary	160
10.6.1 Configuring Firewall Rules	162
10.6.2 Customized Services	165
10.6.3 Configuring A Customized Service	166
10.7 Example Firewall Rule	166
10.8 Predefined Services	170
10.9 Anti-Probing	172
10.10 DoS Thresholds	173
10.10.1 Threshold Values	173
10.10.2 Half-Open Sessions	174
10.10.2.1 TCP Maximum Incomplete and Blocking Time	174
10.10.3 Configuring Firewall Thresholds	175
Chapter 11	
Content Filtering	178
11.1 Content Filtering Overview	178
11.2 Configuring Keyword Blocking	178
11.3 Configuring the Schedule	179
11.4 Configuring Trusted Computers	180
Chapter 12	
Static Route	182
12.1 Static Route	182
12.2 Configuring Static Route	182
12.2.1 Static Route Edit	183
Chapter 13	
Bandwidth Management	186
13.1 Bandwidth Management Overview	186
13.2 Application-based Bandwidth Management	186
13.3 Subnet-based Bandwidth Management	186
13.4 Application and Subnet-based Bandwidth Management	187
13.5 Scheduler	187
13.5.1 Priority-based Scheduler	187
13.5.2 Fairness-based Scheduler	188
13.6 Maximize Bandwidth Usage	188
13.6.1 Reserving Bandwidth for Non-Bandwidth Class Traffic	188
13.6.2 Maximize Bandwidth Usage Example	189
13.6.2.1 Priority-based Allotment of Unused and Unbudgeted Bandwidth	189
13.6.2.2 Fairness-based Allotment of Unused and Unbudgeted Bandwidth	190

13.6.3 Bandwidth Management Priorities	190
13.7 Over Allotment of Bandwidth	191
13.8 Configuring Summary	191
13.9 Bandwidth Management Rule Setup	192
13.9.1 Rule Configuration	194
13.10 Bandwidth Monitor	196
Chapter 14	
Dynamic DNS Setup.....	198
14.1 Dynamic DNS Overview	198
14.1.1 DYNDNS Wildcard	198
14.2 Configuring Dynamic DNS	198
Chapter 15	
Remote Management Configuration	202
15.1 Remote Management Overview	202
15.1.1 Remote Management Limitations	202
15.1.2 Remote Management and NAT	203
15.1.3 System Timeout	203
15.2 WWW	203
15.3 Telnet	204
15.4 Configuring Telnet	204
15.5 Configuring FTP	205
15.6 SNMP	206
15.6.1 Supported MIBs	207
15.6.2 SNMP Traps	208
15.6.3 Configuring SNMP	208
15.7 Configuring DNS	209
15.8 Configuring ICMP	210
15.9 TR-069	211
Chapter 16	
Universal Plug-and-Play (UPnP)	214
16.1 Introducing Universal Plug and Play	214
16.1.1 How do I know if I'm using UPnP?	214
16.1.2 NAT Traversal	214
16.1.3 Cautions with UPnP	215
16.2 UPnP and ZyXEL	215
16.2.1 Configuring UPnP	215
16.3 Installing UPnP in Windows Example	216
16.3.1 Installing UPnP in Windows Me	216
16.3.2 Installing UPnP in Windows XP	218
16.4 Using UPnP in Windows XP Example	219

16.4.1 Auto-discover Your UPnP-enabled Network Device	219
16.4.2 Web Configurator Easy Access	222
Chapter 17	
System	226
17.1 General Setup	226
17.1.1 General Setup and System Name	226
17.1.2 General Setup	226
17.2 Time Setting	228
Chapter 18	
Logs	232
18.1 Logs Overview	232
18.1.1 Alerts and Logs	232
18.2 Viewing the Logs	232
18.3 Configuring Log Settings	233
18.3.1 Example E-mail Log	236
Chapter 19	
Tools	238
19.1 Firmware Upgrade	238
19.2 Configuration Screen	240
19.2.1 Backup Configuration	240
19.2.2 Restore Configuration	241
19.2.3 Back to Factory Defaults	242
19.3 Restart	242
Chapter 20	
Diagnostic	244
20.1 General Diagnostic	244
20.2 DSL Line Diagnostic	245
Chapter 21	
Troubleshooting	246
21.1 Problems Starting Up the ZyXEL Device	246
21.2 Problems with the LAN	246
21.3 Problems with the WAN	247
21.4 Problems Accessing the ZyXEL Device	248
Appendix A	
Product Specifications	250
Appendix B	
About ADSL	254

Introduction to DSL	254
ADSL Overview	254
Advantages of ADSL	254
Appendix C	
Internal SPTGEN	256
Internal SPTGEN Overview	256
The Configuration Text File Format	256
Internal SPTGEN FTP Download Example	257
Internal SPTGEN FTP Upload Example	258
Example Internal SPTGEN Menus	259
Command Examples	271
Appendix D	
Wall-mounting Instructions	272
Appendix E	
Setting up Your Computer's IP Address	274
Windows 95/98/Me	274
Windows 2000/NT/XP	277
Macintosh OS 8/9	282
Macintosh OS X	284
Linux	285
21.4.1 Verifying Settings	289
Appendix F	
IP Addresses and Subnetting	290
Introduction to IP Addresses	290
Subnet Masks	292
Subnetting	292
Example: Two Subnets	293
Example: Four Subnets	294
Example Eight Subnets	295
Subnetting With Class A and Class B Networks	296
Appendix G	
Command Interpreter	298
Accessing the CLI	298
Command Syntax	298
Command Usage	298
Appendix H	
Firewall Commands	300

Appendix I	
NetBIOS Filter Commands	306
Introduction	306
Display NetBIOS Filter Settings	306
NetBIOS Filter Configuration.....	307
Appendix J	
Splitters and Microfilters	308
Connecting a POTS Splitter	308
Telephone Microfilters	308
ZyXEL Device With ISDN.....	310
Appendix K	
Log Descriptions.....	312
Log Commands.....	326
Log Command Example.....	327
Appendix L	
Wireless LANs	328
Wireless LAN Topologies	328
Channel.....	330
RTS/CTS.....	330
Fragmentation Threshold	331
Preamble Type	332
IEEE 802.11g Wireless LAN	332
Wireless Security Overview	333
IEEE 802.1x	333
RADIUS.....	334
Types of Authentication.....	335
Dynamic WEP Key Exchange.....	336
WPA and WPA2	337
21.4.2 WPA(2)-PSK Application Example	339
Security Parameters Summary	340
Appendix M	
Pop-up Windows, JavaScripts and Java Permissions	342
Internet Explorer Pop-up Blockers	342
JavaScripts.....	345
Appendix N	
Triangle Route	350

The Ideal Setup.....	350
The “Triangle Route” Problem.....	350
The “Triangle Route” Solutions	351
IP Aliasing	351
Index.....	352

List of Figures

Figure 1 Protected Internet Access Applications	39
Figure 2 LAN-to-LAN Application Example	39
Figure 3 Front Panel (P-660HW-D)	40
Figure 4 Front Panel (P-660H-D)	40
Figure 5 Password Screen	43
Figure 6 Change Password at Login	43
Figure 7 Select a Mode	44
Figure 8 Web Configurator: Main Screen	45
Figure 9 Status Screen	48
Figure 10 Status: Any IP Table	50
Figure 11 Status: WLAN Status	51
Figure 12 Status: Bandwidth Status	51
Figure 13 Status: Packet Statistics	52
Figure 14 System General	54
Figure 15 Select a Mode	56
Figure 16 Wizard: Welcome	57
Figure 17 Auto Detection: No DSL Connection	57
Figure 18 Auto Detection: Failed	58
Figure 19 Auto-Detection: PPPoE	58
Figure 20 Internet Access Wizard Setup: ISP Parameters	59
Figure 21 Internet Connection with PPPoE	60
Figure 22 Internet Connection with RFC 1483	60
Figure 23 Internet Connection with ENET ENCAP	61
Figure 24 Internet Connection with PPPoA	62
Figure 25 Connection Test Failed-1	63
Figure 26 Connection Test Failed-2.	63
Figure 27 Connection Test Successful	64
Figure 28 Wireless LAN Setup Wizard 1	64
Figure 29 Wireless LAN Setup Wizard 2	65
Figure 30 Manually assign a WPA key	67
Figure 31 Manually assign a WEP key	67
Figure 32 Wireless LAN Setup 3	68
Figure 33 Internet Access and WLAN Wizard Setup Complete	69
Figure 34 Select a Mode	71
Figure 35 Wizard: Welcome	72
Figure 36 Bandwidth Management Wizard: General Information	72
Figure 37 Bandwidth Management Wizard: Configuration	73
Figure 38 Bandwidth Management Wizard: Complete	74

Figure 39 Example of Traffic Shaping	80
Figure 40 Internet Connection (PPPoE)	82
Figure 41 Advanced Internet Connection Setup	84
Figure 42 More Connections	86
Figure 43 More Connections Edit	87
Figure 44 More Connections Advanced Setup	89
Figure 45 Traffic Redirect Example	90
Figure 46 Traffic Redirect LAN Setup	91
Figure 47 WAN Backup Setup	91
Figure 48 LAN and WAN IP Addresses	94
Figure 49 Any IP Example	99
Figure 50 LAN IP	100
Figure 51 Advanced LAN Setup	101
Figure 52 DHCP Setup	102
Figure 53 LAN Client List	103
Figure 54 Physical Network & Partitioned Logical Networks	105
Figure 55 LAN IP Alias	105
Figure 56 Example of a Wireless Network	108
Figure 57 Wireless LAN: General	112
Figure 58 Wireless: No Security	113
Figure 59 Wireless: Static WEP Encryption	114
Figure 60 Wireless: WPA-PSK/WPA2-PSK	115
Figure 61 Wireless: WPA/WPA2	117
Figure 62 Advanced	119
Figure 63 OTIST	121
Figure 64 Example Wireless Client OTIST Screen	122
Figure 65 Security Key	123
Figure 66 OTIST in Progress (AP)	123
Figure 67 OTIST in Progress (Client)	123
Figure 68 No AP with OTIST Found	123
Figure 69 Start OTIST?	124
Figure 70 MAC Address Filter	125
Figure 71 Wireless LAN: QoS	129
Figure 72 Application Priority Configuration	130
Figure 73 How NAT Works	133
Figure 74 NAT Application With IP Alias	134
Figure 75 NAT General (P-660H-D)	136
Figure 76 Multiple Servers Behind NAT Example	138
Figure 77 NAT Port Forwarding	138
Figure 78 Port Forwarding Rule Setup	139
Figure 79 Address Mapping Rules	141
Figure 80 Edit Address Mapping Rule	142
Figure 81 Firewall Application	146

Figure 82 Three-Way Handshake	147
Figure 83 SYN Flood	148
Figure 84 Smurf Attack	149
Figure 85 Stateful Inspection	150
Figure 86 Firewall: General	159
Figure 87 Firewall Rules	161
Figure 88 Firewall: Edit Rule	163
Figure 89 Firewall: Customized Services	165
Figure 90 Firewall: Configure Customized Services	166
Figure 91 Firewall Example: Rules	167
Figure 92 Edit Custom Port Example	167
Figure 93 Firewall Example: Edit Rule: Destination Address	168
Figure 94 Firewall Example: Edit Rule: Select Customized Services	169
Figure 95 Firewall Example: Rules: MyService	170
Figure 96 Firewall: Anti Probing	172
Figure 97 Firewall: Threshold	175
Figure 98 Content Filter: Keyword	178
Figure 99 Content Filter: Schedule	179
Figure 100 Content Filter: Trusted	180
Figure 101 Example of Static Routing Topology	182
Figure 102 Static Route	183
Figure 103 Static Route Edit	184
Figure 104 Subnet-based Bandwidth Management Example	187
Figure 105 Bandwidth Management: Summary	191
Figure 106 Bandwidth Management: Rule Setup	193
Figure 107 Bandwidth Management Rule Configuration	194
Figure 108 Bandwidth Management: Monitor	196
Figure 109 Dynamic DNS	199
Figure 110 Remote Management: WWW	203
Figure 111 Telnet Configuration on a TCP/IP Network	204
Figure 112 Remote Management: Telnet	205
Figure 113 Remote Management: FTP	206
Figure 114 SNMP Management Model	207
Figure 115 Remote Management: SNMP	208
Figure 116 Remote Management: DNS	210
Figure 117 Remote Management: ICMP	211
Figure 118 Enabling TR-069	212
Figure 119 Configuring UPnP	215
Figure 120 Add/Remove Programs: Windows Setup: Communication	217
Figure 121 Add/Remove Programs: Windows Setup: Communication: Components	217
Figure 122 Network Connections	218
Figure 123 Windows Optional Networking Components Wizard	218
Figure 124 Networking Services	219

Figure 125 Network Connections	220
Figure 126 Internet Connection Properties	220
Figure 127 Internet Connection Properties: Advanced Settings	221
Figure 128 Internet Connection Properties: Advanced Settings: Add	221
Figure 129 System Tray Icon	221
Figure 130 Internet Connection Status	222
Figure 131 Network Connections	223
Figure 132 Network Connections: My Network Places	224
Figure 133 Network Connections: My Network Places: Properties: Example	224
Figure 134 System General Setup	227
Figure 135 System Time Setting	228
Figure 136 View Log	233
Figure 137 Log Settings	234
Figure 138 E-mail Log Example	236
Figure 139 Firmware Upgrade	238
Figure 140 Firmware Upload In Progress	239
Figure 141 Network Temporarily Disconnected	239
Figure 142 Error Message	240
Figure 143 Configuration	240
Figure 144 Configuration Restore Successful	241
Figure 145 Temporarily Disconnected	241
Figure 146 Configuration Restore Error	242
Figure 147 Restart Screen	242
Figure 148 Diagnostic: General	244
Figure 149 Diagnostic: DSL Line	245
Figure 150 Configuration Text File Format: Column Descriptions	256
Figure 151 Invalid Parameter Entered: Command Line Example	257
Figure 152 Valid Parameter Entered: Command Line Example	257
Figure 153 Internal SPTGEN FTP Download Example	258
Figure 154 Internal SPTGEN FTP Upload Example	258
Figure 155 Wall-mounting Example	272
Figure 156 Windows 95/98/Me: Network: Configuration	275
Figure 157 Windows 95/98/Me: TCP/IP Properties: IP Address	276
Figure 158 Windows 95/98/Me: TCP/IP Properties: DNS Configuration	277
Figure 159 Windows XP: Start Menu	278
Figure 160 Windows XP: Control Panel	278
Figure 161 Windows XP: Control Panel: Network Connections: Properties	279
Figure 162 Windows XP: Local Area Connection Properties	279
Figure 163 Windows XP: Internet Protocol (TCP/IP) Properties	280
Figure 164 Windows XP: Advanced TCP/IP Properties	281
Figure 165 Windows XP: Internet Protocol (TCP/IP) Properties	282
Figure 166 Macintosh OS 8/9: Apple Menu	283
Figure 167 Macintosh OS 8/9: TCP/IP	283

Figure 168 Macintosh OS X: Apple Menu	284
Figure 169 Macintosh OS X: Network	285
Figure 170 Red Hat 9.0: KDE: Network Configuration: Devices	286
Figure 171 Red Hat 9.0: KDE: Ethernet Device: General	286
Figure 172 Red Hat 9.0: KDE: Network Configuration: DNS	287
Figure 173 Red Hat 9.0: KDE: Network Configuration: Activate	287
Figure 174 Red Hat 9.0: Dynamic IP Address Setting in ifconfig-eth0	288
Figure 175 Red Hat 9.0: Static IP Address Setting in ifconfig-eth0	288
Figure 176 Red Hat 9.0: DNS Settings in resolv.conf	288
Figure 177 Red Hat 9.0: Restart Ethernet Card	289
Figure 178 Red Hat 9.0: Checking TCP/IP Properties	289
Figure 179 Connecting a POTS Splitter	308
Figure 180 Connecting a Microfilter	309
Figure 181 Connecting a Microfilter and Y-Connector	309
Figure 182 ZyXEL Device with ISDN	310
Figure 183 Displaying Log Categories Example	326
Figure 184 Displaying Log Parameters Example	326
Figure 185 Peer-to-Peer Communication in an Ad-hoc Network	328
Figure 186 Basic Service Set	329
Figure 187 Infrastructure WLAN	330
Figure 188 RTS/CTS	331
Figure 189 WPA(2) with RADIUS Application Example	339
Figure 190 WPA(2)-PSK Authentication	340
Figure 191 Pop-up Blocker	342
Figure 192 Internet Options	343
Figure 193 Internet Options	344
Figure 194 Pop-up Blocker Settings	345
Figure 195 Internet Options	346
Figure 196 Security Settings - Java Scripting	347
Figure 197 Security Settings - Java	348
Figure 198 Java (Sun)	349
Figure 199 Ideal Setup	350
Figure 200 "Triangle Route" Problem	351
Figure 201 IP Alias	351

List of Tables

Table 1 ADSL Standards	35
Table 2 Front Panel LEDs	40
Table 3 Web Configurator Screens Summary	45
Table 4 Status Screen	48
Table 5 Status: Any IP Table	50
Table 6 Status: WLAN Status	51
Table 7 Status: Packet Statistics	52
Table 8 Internet Access Wizard Setup: ISP Parameters	59
Table 9 Internet Connection with PPPoE	60
Table 10 Internet Connection with RFC 1483	61
Table 11 Internet Connection with ENET ENCAP	61
Table 12 Internet Connection with PPPoA	62
Table 13 Wireless LAN Setup Wizard 1	65
Table 14 Wireless LAN Setup Wizard 2	66
Table 15 Manually assign a WPA key	67
Table 16 Manually assign a WEP key	68
Table 17 Media Bandwidth Management Setup: Services	70
Table 18 Bandwidth Management Wizard: General Information	72
Table 19 Bandwidth Management Wizard: Configuration	73
Table 20 Internet Connection	82
Table 21 Advanced Internet Connection Setup	84
Table 22 More Connections	86
Table 23 More Connections Edit	87
Table 24 More Connections Advanced Setup	89
Table 25 WAN Backup Setup	92
Table 26 LAN IP	100
Table 27 Advanced LAN Setup	101
Table 28 DHCP Setup	102
Table 29 LAN Client List	104
Table 30 LAN IP Alias	105
Table 31 Types of Encryption for Each Type of Authentication	110
Table 32 Wireless LAN: General	112
Table 33 Wireless No Security	113
Table 34 Wireless: Static WEP Encryption	114
Table 35 Wireless: WPA-PSK/WPA2-PSK	116
Table 36 Wireless: WPA/WPA2	117
Table 37 Wireless LAN: Advanced	119
Table 38 OTIST	122

Table 39 MAC Address Filter	125
Table 40 WMM QoS Priorities	126
Table 41 Commonly Used Services	127
Table 42 Wireless LAN: QoS	129
Table 43 Application Priority Configuration	130
Table 44 NAT Definitions	132
Table 45 NAT Mapping Types	135
Table 46 NAT General	136
Table 47 Services and Port Numbers	137
Table 48 NAT Port Forwarding	139
Table 49 Port Forwarding Rule Setup	140
Table 50 Address Mapping Rules	141
Table 51 Edit Address Mapping Rule	142
Table 52 Common IP Ports	147
Table 53 ICMP Commands That Trigger Alerts	149
Table 54 Legal NetBIOS Commands	149
Table 55 Legal SMTP Commands	149
Table 56 Firewall: General	160
Table 57 Firewall Rules	161
Table 58 Firewall: Edit Rule	164
Table 59 Customized Services	165
Table 60 Firewall: Configure Customized Services	166
Table 61 Predefined Services	170
Table 62 Firewall: Anti Probing	173
Table 63 Firewall: Threshold	175
Table 64 Content Filter: Keyword	179
Table 65 Content Filter: Schedule	180
Table 66 Content Filter: Trusted	180
Table 67 Static Route	183
Table 68 Static Route Edit	184
Table 69 Application and Subnet-based Bandwidth Management Example	187
Table 70 Maximize Bandwidth Usage Example	189
Table 71 Priority-based Allotment of Unused and Unbudgeted Bandwidth Example	189
Table 72 Fairness-based Allotment of Unused and Unbudgeted Bandwidth Example	190
Table 73 Bandwidth Management Priorities	190
Table 74 Over Allotment of Bandwidth Example	191
Table 75 Media Bandwidth Management: Summary	192
Table 76 Bandwidth Management: Rule Setup	193
Table 77 Bandwidth Management Rule Configuration	194
Table 78 Services and Port Numbers	196
Table 79 Dynamic DNS	199
Table 80 Remote Management: WWW	204
Table 81 Remote Management: Telnet	205

Table 82 Remote Management: FTP	206
Table 83 SNMP Traps	208
Table 84 Remote Management: SNMP	209
Table 85 Remote Management: DNS	210
Table 86 Remote Management: ICMP	211
Table 87 TR-069 Commands	212
Table 88 Configuring UPnP	216
Table 89 System General Setup	227
Table 90 System Time Setting	229
Table 91 View Log	233
Table 92 Log Settings	234
Table 93 Firmware Upgrade	238
Table 94 Maintenance Restore Configuration	241
Table 95 Diagnostic: General	244
Table 96 Diagnostic: DSL Line	245
Table 97 Troubleshooting Starting Up Your ZyXEL Device	246
Table 98 Troubleshooting the LAN	246
Table 99 Troubleshooting the WAN	247
Table 100 Troubleshooting Accessing the ZyXEL Device	248
Table 101 Device	250
Table 102 Firmware	251
Table 103 Abbreviations Used in the Example Internal SPTGEN Screens Table	259
Table 104 Menu 1 General Setup	259
Table 105 Menu 3	259
Table 106 Menu 4 Internet Access Setup	263
Table 107 Menu 12	264
Table 108 Menu 15 SUA Server Setup	265
Table 109 Menu 21.1 Filter Set #1	266
Table 110 Menu 21.1 Filter Set #2,	268
Table 111 Menu 23 System Menus	269
Table 112 Menu 24.11 Remote Management Control	270
Table 113 Command Examples	271
Table 114 Classes of IP Addresses	291
Table 115 Allowed IP Address Range By Class	291
Table 116 "Natural" Masks	292
Table 117 Alternative Subnet Mask Notation	292
Table 118 Two Subnets Example	293
Table 119 Subnet 1	293
Table 120 Subnet 2	294
Table 121 Subnet 1	294
Table 122 Subnet 2	295
Table 123 Subnet 3	295
Table 124 Subnet 4	295

Table 125 Eight Subnets	296
Table 126 Class C Subnet Planning	296
Table 127 Class B Subnet Planning	297
Table 128 Firewall Commands	300
Table 129 NetBIOS Filter Default Settings	307
Table 130 System Maintenance Logs	312
Table 131 System Error Logs	313
Table 132 Access Control Logs	313
Table 133 TCP Reset Logs	314
Table 134 Packet Filter Logs	314
Table 135 ICMP Logs	315
Table 136 CDR Logs	315
Table 137 PPP Logs	315
Table 138 UPnP Logs	316
Table 139 Content Filtering Logs	316
Table 140 Attack Logs	317
Table 141 IPSec Logs	318
Table 142 IKE Logs	318
Table 143 PKI Logs	321
Table 144 Certificate Path Verification Failure Reason Codes	322
Table 145 802.1X Logs	323
Table 146 ACL Setting Notes	324
Table 147 ICMP Notes	324
Table 148 Syslog Logs	325
Table 149 RFC-2408 ISAKMP Payload Types	325
Table 150 IEEE 802.11g	332
Table 151 Wireless Security Levels	333
Table 152 Comparison of EAP Authentication Types	336
Table 153 Wireless Security Relational Matrix	340

Preface

Congratulations on your purchase of the P-660HW-D series 802.11g Wireless ADSL 2+ 4-port Gateway or P-660H-D ADSL2+ 4-port Gateway. The P-660HW comes with built-in IEEE 802.11g wireless capability allowing wireless connectivity. The P-660HW-D and P-660H-D have a 4-port switch that allows you to connect up to 4 computers to the P-660H-D or the P-660HW-D without purchasing a switch/hub.

Note: Register your product online to receive e-mail notices of firmware upgrades and information at www.zyxel.com for global products, or at www.us.zyxel.com for North American products.

About This User's Guide

This manual is designed to guide you through the configuration of your ZyXEL Device for its various applications. The web configurator parts of this guide contain background information on features configurable by web configurator.

Note: Use the web configurator or command interpreter interface to configure your ZyXEL Device. Not all features can be configured through all interfaces.

Syntax Conventions

- “Enter” means for you to type one or more characters. “Select” or “Choose” means for you to use one predefined choice.
- Mouse action sequences are denoted using a right angle bracket (>). For example, “In Windows, click **Start > Settings > Control Panel**” means first click the **Start** button, then point your mouse pointer to **Settings** and then click **Control Panel**.
- “e.g.,” is a shorthand for “for instance”, and “i.e.,” means “that is” or “in other words”.
- The P-660HW-D or P-660H-D series may be referred to as the “ZyXEL Device” in this User’s Guide.

Related Documentation











- Supporting Disk
Refer to the included CD for support documents.
- Quick Start Guide
The Quick Start Guide is designed to help you get up and running right away. It contains connection information and instructions on getting started.
- Web Configurator Online Help
Embedded web help for descriptions of individual screens and supplementary information.
- ZyXEL Web Site

Please go to <http://www.zyxel.com> for product news, firmware, updated documents, and other support materials.

User Guide Feedback

Help us help you. E-mail all User Guide-related comments, questions or suggestions for improvement to techwriters@zyxel.com.tw or send regular mail to The Technical Writing Team, ZyXEL Communications Corp., 6 Innovation Road II, Science-Based Industrial Park, Hsinchu, 300, Taiwan. Thank you.

Graphics Icons Key

ZyXEL Device 	Computer 	Notebook computer 
Server 	DSLAM 	Firewall 
Telephone 	Switch 	Router 
Wireless Signal 		

CHAPTER 1

Getting To Know Your ZYXEL DEVICE

This chapter describes the key features and applications of your ZyXEL Device.

1.1 Introducing the ZyXEL Device

The ZyXEL Device is an ADSL2+ gateway that allows super-fast, secure Internet access over analog (POTS) or digital (ISDN) telephone lines (depending on your model).

In the ZyXEL Device product name, “H” denotes an integrated 4-port switch (hub) and “W” denotes an included wireless LAN card that provides wireless connectivity.

Models ending in “1”, for example P-660HW-D1, denote a device that works over the analog telephone system, POTS (Plain Old Telephone Service). Models ending in “3” denote a device that works over ISDN (Integrated Services Digital Network). Models ending in “7” denote a device that works over T-ISDN (UR-2).

Note: Only use firmware for your ZyXEL Device’s specific model. Refer to the label on the bottom of your ZyXEL Device.

The DSL RJ-11 (ADSL over POTS models) or RJ-45 (ADSL over ISDN models) connects to your ADSL-enabled telephone line. The ZyXEL Device is compatible with the ADSL/ADSL2/ADSL2+ standards.

1.2 Features

High Speed Internet Access

The ZyXEL Device is ideal for high-speed Internet browsing and making LAN-to-LAN connections to remote networks. The ZyXEL Device is compatible with the ADSL/ADSL2/ADSL2+ standards. Maximum data rates attainable for each standard are shown in the next table.

Table 1 ADSL Standards

DATA RATE STANDARD	UPSTREAM	DOWNSTREAM
ADSL	832 kbps	8Mbps
ADSL2	3.5Mbps	12Mbps
ADSL2+	3.5Mbps	24Mbps

Note: If your ZyXEL Device does not support Annex M, the maximum ADSL2/2+ upstream data rate is 1.2 Mbps. ZyXEL Devices which work over ISDN do not support Annex M.

The standard your ISP supports determines the maximum upstream and downstream speeds attainable. Actual speeds attained also depend on the distance from your ISP, line quality, etc.

Zero Configuration Internet Access

Once you connect and turn on the ZyXEL Device, it automatically detects the Internet connection settings (such as the VCI/VPI numbers and the encapsulation method) from the ISP and makes the necessary configuration changes. In cases where additional account information (such as an Internet account user name and password) is required or the ZyXEL Device cannot connect to the ISP, you will be redirected to web screen(s) for information input or troubleshooting.

Any IP

The Any IP feature allows a computer to access the Internet and the ZyXEL Device without changing the network settings (such as IP address and subnet mask) of the computer, when the IP addresses of the computer and the ZyXEL Device are not in the same subnet.

Firewall

The ZyXEL Device is a stateful inspection firewall with DoS (Denial of Service) protection. By default, when the firewall is activated, all incoming traffic from the WAN to the LAN is blocked unless it is initiated from the LAN. The ZyXEL Device firewall supports TCP/UDP inspection, DoS detection and prevention, real time alerts, reports and logs.

Content Filtering

Content filtering allows you to block access to forbidden Internet web sites, schedule when the ZyXEL Device should perform the filtering and give trusted LAN IP addresses unfiltered Internet access.

Traffic Redirect

Traffic redirect forwards WAN traffic to a backup gateway when the ZyXEL Device cannot connect to the Internet, thus acting as an auxiliary if your regular WAN connection fails.

Media Bandwidth Management

ZyXEL's Media Bandwidth Management allows you to specify bandwidth classes based on an application and/or subnet. You can allocate specific amounts of bandwidth capacity (bandwidth budgets) to different bandwidth classes.

Universal Plug and Play (UPnP)

Using the standard TCP/IP protocol, the ZyXEL Device and other UPnP enabled devices can dynamically join a network, obtain an IP address and convey its capabilities to other devices on the network.

PPPoE (RFC2516)

PPPoE (Point-to-Point Protocol over Ethernet) emulates a dial-up connection. It allows your ISP to use their existing network configuration with newer broadband technologies such as ADSL. The PPPoE driver on the ZyXEL Device is transparent to the computers on the LAN, which see only Ethernet and are not aware of PPPoE thus saving you from having to manage PPPoE clients on individual computers. The ZyXEL Device also includes PPPoE idle time-out (the PPPoE connection terminates after a period of no traffic that you configure) and PPPoE Dial-on-Demand (the PPPoE connection is brought up only when an Internet access request is made).

Network Address Translation (NAT)

Network Address Translation (NAT) allows the translation of an Internet protocol address used within one network (for example a private IP address used in a local network) to a different IP address known within another network (for example a public IP address used on the Internet).

Dynamic DNS Support

With Dynamic DNS support, you can have a static hostname alias for a dynamic IP address, allowing the host to be more easily accessible from various locations on the Internet. You must register for this service with a Dynamic DNS service provider.

DHCP

DHCP (Dynamic Host Configuration Protocol) allows the individual clients (computers) to obtain the TCP/IP configuration at start-up from a centralized DHCP server. The ZyXEL Device has built-in DHCP server capability enabled by default. It can assign IP addresses, an IP default gateway and DNS servers to DHCP clients. The ZyXEL Device can now also act as a surrogate DHCP server (DHCP Relay) where it relays IP address assignment from the actual real DHCP server to the clients.

IP Alias

IP Alias allows you to partition a physical network into logical networks over the same Ethernet interface. The ZyXEL Device supports three logical LAN interfaces via its single physical Ethernet interface with the ZyXEL Device itself as the gateway for each LAN network.

TR-069 Compliance

TR-069 is a protocol that defines how your P-660H-D can be managed via a management server such as ZyXEL's Vantage CNM Access. The management server can securely manage and update configuration changes in the P-660H-Ds.

Housing

Your ZyXEL Device's compact and ventilated housing minimizes space requirements making it easy to position anywhere in your busy office.

4-port Switch

A combination of switch and router makes your ZyXEL Device a cost-effective and viable network solution. You can connect up to four computers to the ZyXEL Device without the cost of a hub. Use a hub to add more than four computers to your LAN.

1.2.1 Wireless Features (P-660HW-D Only)

Wireless LAN

The ZyXEL Device supports the IEEE 802.11g standard, which is fully compatible with the IEEE 802.11b standard, meaning that you can have both IEEE 802.11b and IEEE 802.11g wireless clients in the same wireless network.

Note: The ZyXEL Device may be prone to RF (Radio Frequency) interference from other 2.4 GHz devices such as microwave ovens, wireless phones, Bluetooth enabled devices, and other wireless LANs.

Wi-Fi Protected Access

Wi-Fi Protected Access (WPA) is a subset of the IEEE 802.11i security specification standard. Key differences between WPA and WEP are user authentication and improved data encryption.

WPA2

WPA 2 (IEEE 802.11i) is a wireless security standard that defines stronger encryption, authentication and key management than WPA.

Both WPA and WPA2 improve data encryption by using Temporal Key Integrity Protocol (TKIP), Message Integrity Check (MIC) and IEEE 802.1x. In addition to TKIP, WPA2 also uses Advanced Encryption Standard (AES) in the Counter mode with Cipher block chaining Message authentication code Protocol (CCMP) to offer stronger encryption.

Antenna

The ZyXEL Device is equipped with one 3dBi fixed antenna to provide clear radio signal between the wireless stations and the access points.

WEP Encryption

WEP (Wired Equivalent Privacy) encrypts data frames before transmitting over the wireless network to help keep network communications private.

Output Power Management

Output power management is the ability to set the level of output power.

There may be interference or difficulty with channel assignment when there is a high density of APs within a coverage area. In this case you can lower the output power of each access point, thus enabling you to place access points closer together.

Wireless LAN MAC Address Filtering

Your ZyXEL Device can check the MAC addresses of wireless stations against a list of allowed or denied MAC addresses.

1.3 Applications for the ZyXEL Device

Here are some example uses for which the ZyXEL Device is well suited.

1.3.1 Protected Internet Access

The ZyXEL Device is the ideal high-speed Internet access solution. It is compatible with all major ADSL DSLAM (Digital Subscriber Line Access Multiplexer) providers and supports the ADSL standards as shown in [Table 1 on page 35](#). In addition, the ZyXEL Device with the wireless features allows wireless clients access to your network resources.

The ZyXEL Device provides protection from attacks by Internet hackers. By default, the firewall blocks all incoming traffic from the WAN. The firewall supports TCP/UDP inspection and DoS (Denial of Services) detection and prevention, as well as real time alerts, reports and logs.

Figure 1 Protected Internet Access Applications

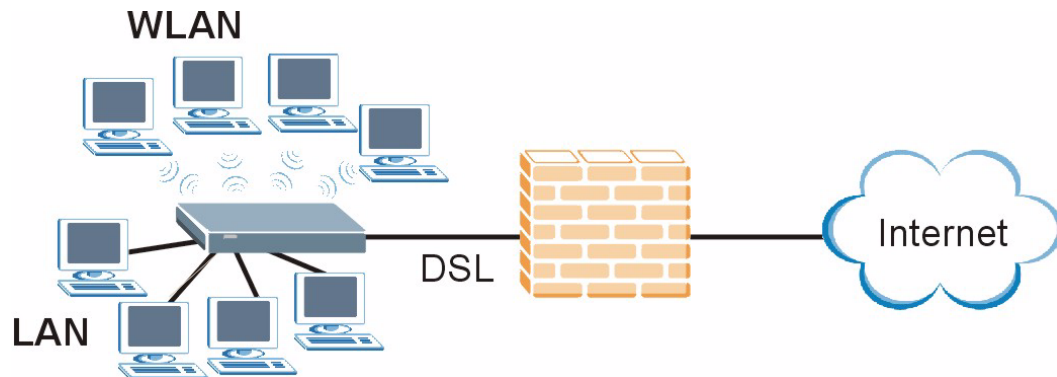

1.3.2 LAN to LAN Application

You can use the ZyXEL Device to connect two geographically dispersed networks over the ADSL line. A typical LAN-to-LAN application example is shown as follows.

Figure 2 LAN-to-LAN Application Example

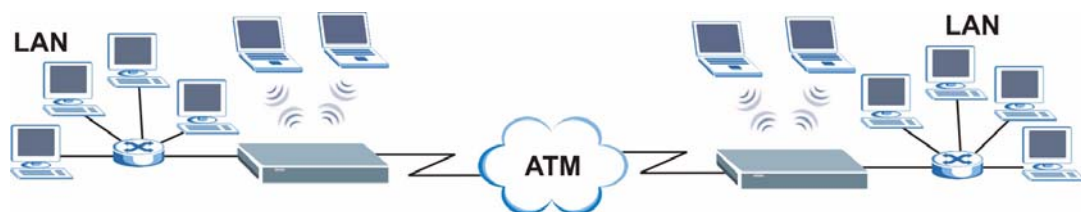

1.4 Front Panel LEDs

The following figure shows the front panel LEDs.

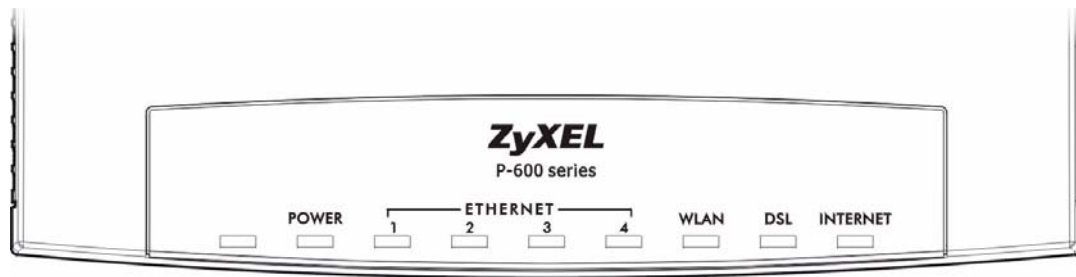
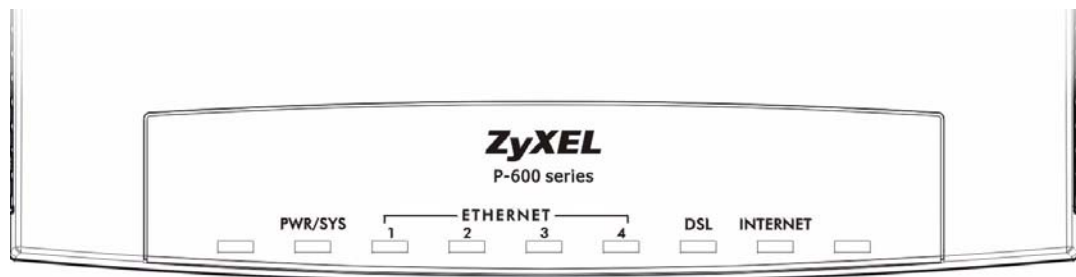
Figure 3 Front Panel (P-660HW-D)**Figure 4** Front Panel (P-660H-D)

The following table describes the LEDs.

Table 2 Front Panel LEDs

LED	COLOR	STATUS	DESCRIPTION
POWER	Green	On	The ZyXEL Device is receiving power and functioning properly.
		Blinking	The ZyXEL Device is rebooting or performing diagnostics.
	Red	On	Power to the ZyXEL Device is too low.
		Off	The system is not ready or has malfunctioned.
ETHERNET	Green	On	The ZyXEL Device has a successful 10Mb Ethernet connection.
		Blinking	The ZyXEL Device is sending/receiving data.
	Amber	On	The ZyXEL Device has a successful 100Mb Ethernet connection.
		Blinking	The ZyXEL Device is sending/receiving data.
		Off	The LAN is not connected.
WLAN (P-660HW-D only)	Green	On	The ZyXEL Device is ready, but is not sending/receiving data through the wireless LAN.
		Blinking	The ZyXEL Device is sending/receiving data through the wireless LAN.
	Off	The wireless LAN is not ready or has failed.	
DSL	Green	On	The DSL line is up.
		Blinking	The ZyXEL Device is initializing the DSL line.
		Off	The DSL line is down.

Table 2 Front Panel LEDs (continued)

LED	COLOR	STATUS	DESCRIPTION
INTERNET	Green	On	The Internet connection is up.
		Blinking	The ZyXEL Device is sending/receiving data.
		Off	The Internet connection is down.

1.5 Hardware Connection

Refer to the Quick Start Guide for information on hardware connection.

CHAPTER 2

Introducing the Web Configurator

This chapter describes how to access and navigate the web configurator.

2.1 Web Configurator Overview

The web configurator is an HTML-based management interface that allows easy ZyXEL Device setup and management via Internet browser. Use Internet Explorer 6.0 and later or Netscape Navigator 7.0 and later versions. The recommended screen resolution is 1024 by 768 pixels.

In order to use the web configurator you need to allow:

- Web browser pop-up windows from your device. Web pop-up blocking is enabled by default in Windows XP SP (Service Pack) 2.
- JavaScripts (enabled by default).
- Java permissions (enabled by default).

See the chapter on troubleshooting if you need to make sure these functions are allowed in Internet Explorer.

2.2 Accessing the Web Configurator

Note: Even though you can connect to the ZyXEL Device wirelessly, it is recommended that you connect your computer to a LAN port for initial configuration.

- 1** Make sure your ZyXEL Device hardware is properly connected (refer to the Quick Start Guide).
- 2** Prepare your computer/computer network to connect to the ZyXEL Device (refer to the Quick Start Guide).
- 3** Launch your web browser.
- 4** Type "192.168.1.1" as the URL.
- 5** A window displays as shown. Enter the default admin password **1234** to configure the wizards and the advanced features or enter the default user password **user** to view the

status only. Click **Login** to proceed to a screen asking you to change your password or click **Cancel** to revert to the default password.

Figure 5 Password Screen

The image shows the ZyXEL P-660HW-D1 Password Screen. At the top, the ZyXEL logo is displayed in white on a blue background. Below the logo, the model number "P-660HW-D1" is centered. The text "Welcome to your router Configuration Interface" is followed by the instruction "Enter your password and press enter or click 'Login'". A password input field is shown with a key icon and the text "Password:" followed by a white box containing four asterisks. Below the input field are two buttons: "Login" and "Cancel".

- 6** If you entered the user password, skip the next two steps and refer to [Section 2.4.2 on page 47](#) for more information about the **Status** screen.

If you entered the admin password, it is highly recommended you change the default admin password! Enter a new password between 1 and 30 characters, retype it to confirm and click **Apply**; alternatively click **Ignore** to proceed to the main menu if you do not want to change the password now.

Note: If you do not change the password at least once, the following screen appears every time you log in with the admin password.

Figure 6 Change Password at Login

The image shows the ZyXEL Change Password at Login screen. At the top, the ZyXEL logo is displayed in white on a blue background. Below the logo, the text "Use this screen to change the password." is centered. The main text reads: "Your router is currently using the default password. To protect your network from unauthorized users we suggest you change your password at this time. Please select a new password that will be easy to remember yet difficult for others to guess. We suggest you combine text with numbers to make it more difficult for an intruder to guess." Below this text, it says "Enter your new password in the two fields below and click 'Apply'. Otherwise click 'Ignore' to keep the default password". There are two input fields: "New Password:" and "Retype to Confirm:". Below the input fields are two buttons: "Apply" and "Ignore".

- 7** Select **Go to Wizard setup** and click **Apply** to display the wizard main screen. Otherwise, select **Go to Advanced setup** and click **Apply** to display the **Status** screen.

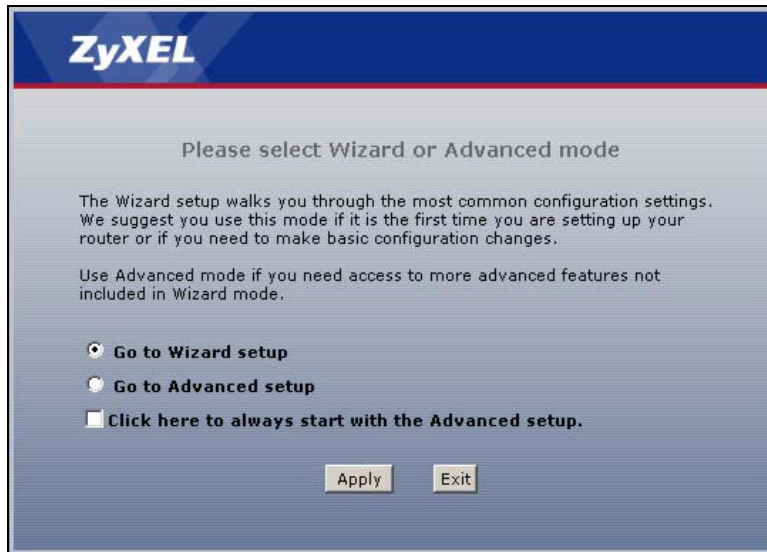
Figure 7 Select a Mode

Note: The management session automatically times out when the time period set in the **Administrator Inactivity Timer** field expires (default five minutes). Simply log back into the ZyXEL Device if this happens to you.

2.3 Resetting the ZyXEL Device

If you forget your password or cannot access the web configurator, you will need to use the **RESET** button at the back of the ZyXEL Device to reload the factory-default configuration file. This means that you will lose all configurations that you had previously and the password will be reset to “1234”.

2.3.1 Using the Reset Button

- 1 Make sure the **POWER LED** is on (not blinking).
- 2 Press the **RESET** button for ten seconds or until the **POWER LED** begins to blink and then release it. When the **POWER LED** begins to blink, the defaults have been restored and the ZyXEL Device restarts.

2.4 Navigating the Web Configurator

We use the P-660HW-D1 web screens in this guide as an example. Screens vary slightly for different ZyXEL Device models.

2.4.1 Navigation Panel

After you enter the admin password, use the sub-menus on the navigation panel to configure ZyXEL Device features. The following table describes the sub-menus.

Figure 8 Web Configurator: Main Screen

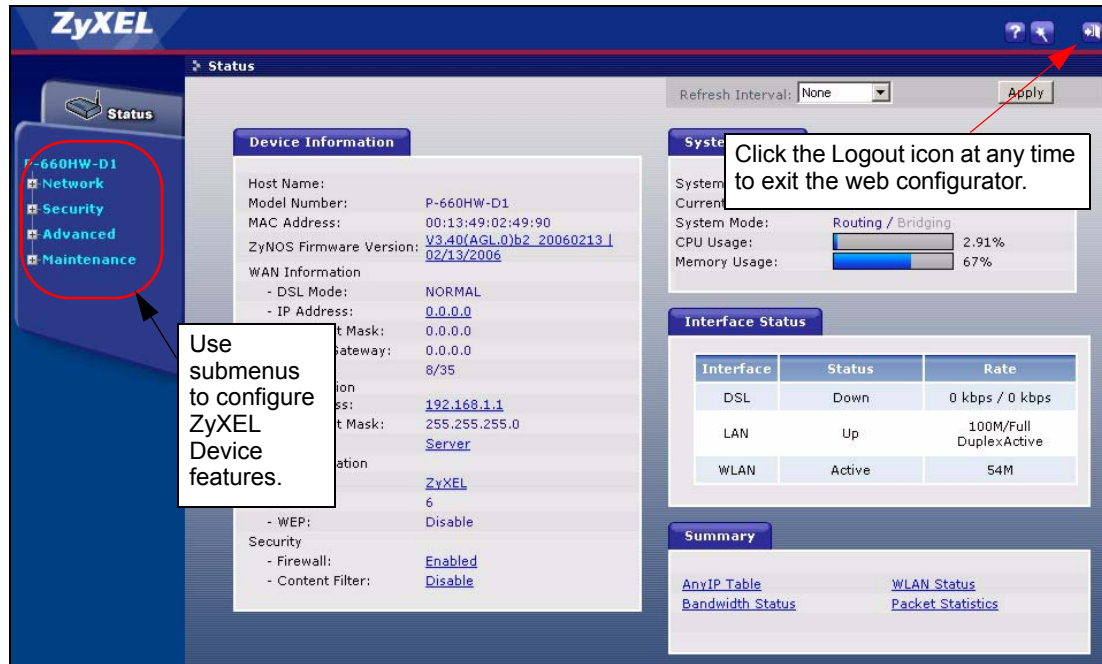

Note: Click the  icon (located in the top right corner of most screens) to view embedded help.

Table 3 Web Configurator Screens Summary



LINK/ICON	SUB-LINK	FUNCTION
Wizard 	INTERNET/WIRELESS SETUP	Use these screens for initial configuration including general setup, ISP parameters for Internet Access and WAN IP/DNS Server/MAC address assignment.
	BANDWIDTH MANAGEMENT SETUP	Use these screens to limit bandwidth usage by application or packet type.
Logout 		Click this icon to exit the web configurator.
Status		This screen shows the ZyXEL Device's general device, system and interface status information. Use this screen to access the summary statistics tables.
Network		
WAN	Internet Connection	This screen allows you to configure ISP parameters, WAN IP address assignment, DNS servers and other advanced properties.
	More Connections	Use this screen to view and configure other connections for placing calls to another remote gateway.
	WAN Backup Setup	Use this screen to configure your traffic redirect properties and WAN backup settings.

Table 3 Web Configurator Screens Summary (continued)

LINK/ICON	SUB-LINK	FUNCTION
LAN	IP	Use this screen to configure LAN TCP/IP settings, enable Any IP and other advanced properties.
	DHCP Setup	Use this screen to configure LAN DHCP settings.
	Client List	Use this screen to view current DHCP client information and to always assign an IP address to a MAC address (and host name).
	IP Alias	Use this screen to partition your LAN interface into subnets.
Wireless LAN (Wireless devices only)	General	Use this screen to configure the wireless LAN settings and WLAN authentication/security settings.
	OTIST	This screen allows you to assign wireless clients the ZyXEL Device's wireless security settings.
	MAC Filter	Use this screen to configure the ZyXEL Device to block access to devices or block the devices from accessing the ZyXEL Device.
	QoS	WMM QoS allows you to prioritize wireless traffic according to the delivery requirements of the individual and applications.
NAT	General	Use this screen to enable NAT.
	Port Forwarding	Use this screen to configure servers behind the ZyXEL Device.
	Address Mapping	Use this screen to configure network address translation mapping rules.
Security		
Firewall	General	Use this screen to activate/deactivate the firewall and the direction of network traffic to which to apply the rule.
	Rules	This screen shows a summary of the firewall rules, and allows you to edit/add a firewall rule.
	Anti Probing	Use this screen to change your anti-probing settings.
	Threshold	Use this screen to configure the threshold for DoS attacks.
Content Filter	Keyword	Use this screen to block sites containing certain keywords in the URL.
	Schedule	Use this screen to set the days and times for the ZyXEL Device to perform content filtering.
	Trusted	Use this screen to exclude a range of users on the LAN from content filtering on your ZyXEL Device.
Advanced		
Static Route		Use this screen to configure IP static routes.
Bandwidth MGMT	Summary	Use this screen to enable bandwidth management on an interface.
	Rule Setup	Use this screen to define a bandwidth rule.
	Monitor	Use this screen to view the ZyXEL Device's bandwidth usage and allotments.
Dynamic DNS		Use this screen to set up dynamic DNS.

Table 3 Web Configurator Screens Summary (continued)

LINK/ICON	SUB-LINK	FUNCTION
Remote MGMT	WWW	Use this screen to configure through which interface(s) and from which IP address(es) users can use HTTPS or HTTP to manage the ZyXEL Device.
	Telnet	Use this screen to configure through which interface(s) and from which IP address(es) users can use Telnet to manage the ZyXEL Device.
	FTP	Use this screen to configure through which interface(s) and from which IP address(es) users can use FTP to access the ZyXEL Device.
	SNMP	Use this screen to configure your ZyXEL Device's settings for Simple Network Management Protocol management.
	DNS	Use this screen to configure through which interface(s) and from which IP address(es) users can send DNS queries to the ZyXEL Device.
	ICMP	Use this screen to change your anti-probing settings.
UPnP		Use this screen to enable UPnP on the ZyXEL Device.
Maintenance		
System	General	This screen contains administrative and system-related information and also allows you to change your password.
	Time Setting	Use this screen to change your ZyXEL Device's time and date.
Logs	View Log	Use this screen to view the logs for the categories that you selected.
	Log Settings	Use this screen to change your ZyXEL Device's log settings.
Tools	Firmware	Use this screen to upload firmware to your ZyXEL Device.
	Configuration	Use this screen to backup and restore the configuration or reset the factory defaults to your ZyXEL Device.
	Restart	This screen allows you to reboot the ZyXEL Device without turning the power off.
Diagnostic	General	These screens display information to help you identify problems with the ZyXEL Device general connection.
	DSL Line	These screens display information to help you identify problems with the DSL line.

2.4.2 Status Screen

The following summarizes how to navigate the web configurator from the **Status** screen. Some fields or links are not available if you entered the user password in the login password screen (see [Figure 5 on page 43](#)). Not all fields are available on all models.

Figure 9 Status Screen

Refresh Interval:

Device Information

Host Name:
 Model Number: P-660HW-D1
 MAC Address: 00:13:49:02:49:90
 ZyNOS Firmware Version: [V3.40\(AGL.0\)b2 | 01/06/2006](#)

WAN Information

- DSL Mode: NORMAL
- IP Address: [0.0.0.0](#)
- IP Subnet Mask: 0.0.0.0
- Default Gateway: 0.0.0.0
- VPI/VCI: 8/35

LAN Information

- IP Address: [192.168.1.1](#)
- IP Subnet Mask: 255.255.255.0
- DHCP: [Server](#)

WLAN Information

- SSID: [ZyXEL](#)
- Channel: 6
- WEP: Disable

Security

- Firewall: [Enabled](#)
- Content Filter: [Disable](#)

System Status

System Uptime: 0:34:55
 Current Date/Time: 01/01/2000 01:02:19
 System Mode: Routing / Bridging
 CPU Usage:
 Memory Usage:

Interface Status

Interface	Status	Rate
DSL	Down	0 kbps / 0 kbps
LAN	Up	100M/Full DuplexActive
WLAN	Active	54M

Summary

[AnyIP Table](#) [WLAN Status](#)
[Bandwidth Status](#) [Packet Statistics](#)

The following table describes the labels shown in the **Status** screen.

Table 4 Status Screen

LABEL	DESCRIPTION
Refresh Interval	Select a number of seconds or None from the drop-down list box to refresh all screen statistics automatically at the end of every time interval or to not refresh the screen statistics.
Apply	Click this button to refresh the status screen statistics.
Device Information	
Host Name	This is the System Name you enter in the Maintenance > System > General screen. It is for identification purposes.
Model Number	This is your ZyXEL Device's model name.
MAC Address	This is the MAC (Media Access Control) or Ethernet address unique to your ZyXEL Device.
ZyNOS Firmware Version	This is the ZyNOS Firmware version and the date created. ZyNOS is ZyXEL's proprietary Network Operating System design.
WAN Information	
DSL Mode	This is the standard that your ZyXEL Device is using.
IP Address	This is the WAN port IP address.
IP Subnet Mask	This is the WAN port IP subnet mask.
Default Gateway	This is the IP address of the default gateway, if applicable.
VPI/VCI	This is the Virtual Path Identifier and Virtual Channel Identifier that you entered in the wizard or WAN screen.

Table 4 Status Screen

LABEL	DESCRIPTION
LAN Information	
IP Address	This is the LAN port IP address.
IP Subnet Mask	This is the LAN port IP subnet mask.
DHCP	This is the LAN port DHCP role - Server , Relay or None .
WLAN Information (Wireless devices only)	
SSID	This is the descriptive name used to identify the ZyXEL Device in the wireless LAN.
Channel	This is the channel number used by the ZyXEL Device now.
WEP	This displays the status of WEP data encryption.
Security	
Firewall	This displays whether or not the ZyXEL Device's firewall is activated.
Content Filter	This displays whether or not the ZyXEL Device's content filtering is activated.
System Status	
System Uptime	This is the total time the ZyXEL Device has been on.
Current Date/Time	This field displays your ZyXEL Device's present date and time.
System Mode	This displays whether the ZyXEL Device is functioning as a router or a bridge.
CPU Usage	This number shows how many kilobytes of the heap memory the ZyXEL Device is using. Heap memory refers to the memory that is not used by ZyNOS (ZyXEL Network Operating System) and is thus available for running processes like NAT, VPN and the firewall. The bar displays what percent of the ZyXEL Device's heap memory is in use. The bar turns from green to red when the maximum is being approached.
Memory Usage	This number shows the ZyXEL Device's total heap memory (in kilobytes). The bar displays what percent of the ZyXEL Device's heap memory is in use. The bar turns from green to red when the maximum is being approached.
Interface Status	
Interface	This displays the ZyXEL Device port types.
Status	This field displays Down (line is down), Up (line is up or connected) if you're using Ethernet encapsulation and Down (line is down), Up (line is up or connected), Idle (line (ppp) idle), Dial (starting to trigger a call) and Drop (dropping a call) if you're using PPPoE encapsulation. For the WLAN port, it displays Active when WLAN is enabled or Inactive when WLAN is disabled.
Rate	For the LAN ports, this displays the port speed and duplex setting. For the WAN port, it displays the downstream and upstream transmission rate. For the WLAN port, it displays the transmission rate when WLAN is enabled or N/A when WLAN is disabled.
Summary	
Any IP Table	Use this screen to view a list of IP addresses and MAC addresses of computers, which are not in the same subnet as the ZyXEL Device.
WLAN Status (Wireless devices only)	This screen displays the MAC address(es) of the wireless stations that are currently associating with the ZyXEL Device.

Table 4 Status Screen

LABEL	DESCRIPTION
Bandwidth Status	Use this screen to view the ZyXEL Device's bandwidth usage and allotments.
Packet Statistics	Use this screen to view port status and packet specific statistics.

2.4.3 Status: Any IP Table

Click the **Any IP Table** hyperlink in the **Status** screen. The Any IP table shows current read-only information (including the IP address and the MAC address) of all network devices that use the Any IP feature to communicate with the ZyXEL Device.

Figure 10 Status: Any IP Table

Any IP Table		
#	IP Address	MAC Address
1	255.255.255.255	11:22:33:44:55:66

Refresh

The following table describes the labels in this screen.

Table 5 Status: Any IP Table

LABEL	DESCRIPTION
#	This is the index number of the host computer.
IP Address	This field displays the IP address of the network device.
MAC Address	This field displays the MAC (Media Access Control) address of the computer with the displayed IP address. Every Ethernet device has a unique MAC address. The MAC address is assigned at the factory and consists of six pairs of hexadecimal characters, for example, 00:A0:C5:00:00:02.
Refresh	Click Refresh to update this screen.

2.4.4 Status: WLAN Status

Click the **WLAN Status** hyperlink in the **Status** screen to view the wireless stations that are currently associated to the ZyXEL Device.

Figure 11 Status: WLAN Status

Wireless LAN- Association List		
#	MAC Address	Association Time
1	00:ac:c5:01:23:45	1

Refresh

The following table describes the labels in this screen.

Table 6 Status: WLAN Status

LABEL	DESCRIPTION
#	This is the index number of an associated wireless station.
MAC Address	This field displays the MAC (Media Access Control) address of an associated wireless station.
Association Time	This field displays the time a wireless station first associated with the ZyXEL Device.
Refresh	Click Refresh to reload this screen.

2.4.5 Status: Bandwidth Status

Click the **Bandwidth Status** hyperlink in the **Status** screen. Select an interface from the drop-down list box to view the bandwidth usage of its bandwidth rules. The gray section of the bar represents the percentage of unused bandwidth and the blue color represents the percentage of bandwidth in use.

Figure 12 Status: Bandwidth Status

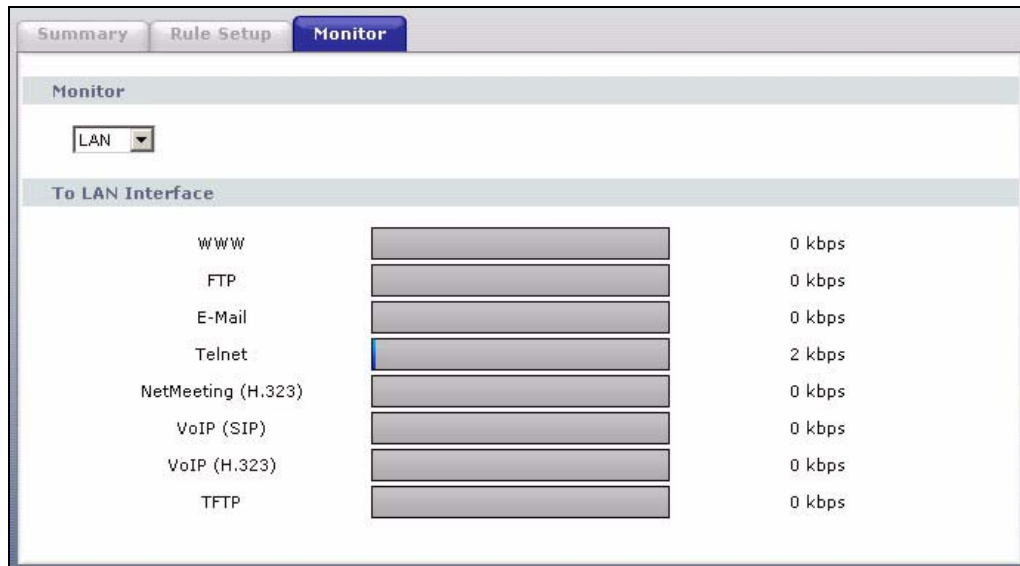

2.4.6 Status: Packet Statistics

Click the **Packet Statistics** hyperlink in the **Status** screen. Read-only information here includes port status and packet specific statistics. Also provided are "system up time" and "poll interval(s)". The **Poll Interval(s)** field is configurable. Not all fields are available on all models

Figure 13 Status: Packet Statistics

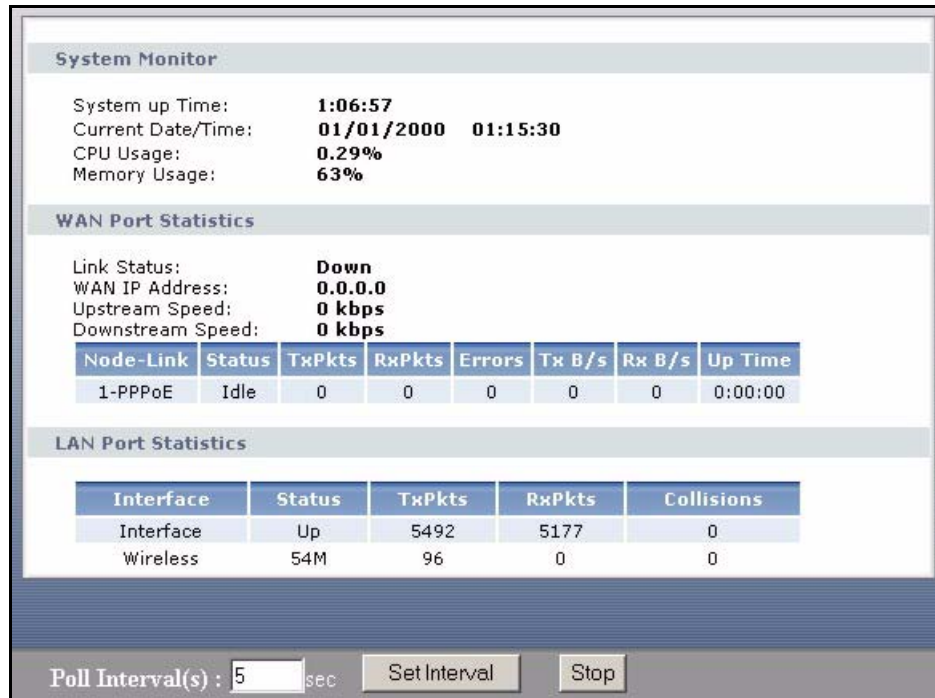

The following table describes the fields in this screen.

Table 7 Status: Packet Statistics

LABEL	DESCRIPTION
System Monitor	
System up Time	This is the elapsed time the system has been up.
Current Date/Time	This field displays your ZyXEL Device's present date and time.
CPU Usage	This field specifies the percentage of CPU utilization.
Memory Usage	This field specifies the percentage of memory utilization.
LAN or WAN Port Statistics	
Link Status	This is the status of your WAN link.
Upstream Speed	This is the upstream speed of your ZyXEL Device.
Downstream Speed	This is the downstream speed of your ZyXEL Device.
Node-Link	This field displays the remote node index number and link type. Link types are PPPoA, ENET, RFC 1483 and PPPoE.
Interface	This field displays the type of port.

Table 7 Status: Packet Statistics (continued)

LABEL	DESCRIPTION
Status	This field displays Down (line is down), Up (line is up or connected) if you're using Ethernet encapsulation and Down (line is down), Up (line is up or connected), Idle (line (ppp) idle), Dial (starting to trigger a call) and Drop (dropping a call) if you're using PPPoE encapsulation. For the WLAN port, it displays the transmission rate when WLAN is enabled or N/A when WLAN is disabled.
TxPkts	This field displays the number of packets transmitted on this port.
RxPkts	This field displays the number of packets received on this port.
Errors	This field displays the number of error packets on this port.
Tx B/s	This field displays the number of bytes transmitted in the last second.
Rx B/s	This field displays the number of bytes received in the last second.
Up Time	This field displays the elapsed time this port has been up.
Collisions	This is the number of collisions on this port.
Poll Interval(s)	Type the time interval for the browser to refresh system statistics.
Set Interval	Click this button to apply the new poll interval you entered in the Poll Interval field above.
Stop	Click this button to halt the refreshing of the system statistics.

2.4.7 Changing Login Password

It is highly recommended that you periodically change the password for accessing the ZyXEL Device. If you didn't change the default one after you logged in or you want to change to a new password again, then click **Maintenance > System** to display the screen as shown next. See [Table 89 on page 227](#) for detailed field descriptions.

Figure 14 System General

General Time Setting

System Setup

System Name

Domain Name

Administrator Inactivity Timer (minutes, 0 means no timeout)

Password

User Password

New Password

Retype to confirm

Admin Password

Old Password

New Password

Retype to confirm

Caution:
Please record your new password whenever you change it. The system will lock you out if you have forgotten your password.

Apply Cancel

CHAPTER 3

Wizard Setup for Internet Access

This chapter provides information on the Wizard Setup screens for Internet access in the web configurator.

3.1 Introduction

Use the wizard setup screens to configure your system for Internet access with the information given to you by your ISP.

Note: See the advanced menu chapters for background information on these fields.

3.2 Internet Access Wizard Setup

- 1 After you enter the admin password to access the web configurator, select **Go to Wizard setup** and click **Apply**. Otherwise, click the wizard icon () in the top right corner of the web configurator to display the wizard main screen.

Figure 15 Select a Mode



- 2 Click **INTERNET/WIRELESS SETUP** to configure the system for Internet access and wireless connection.

Figure 16 Wizard: Welcome

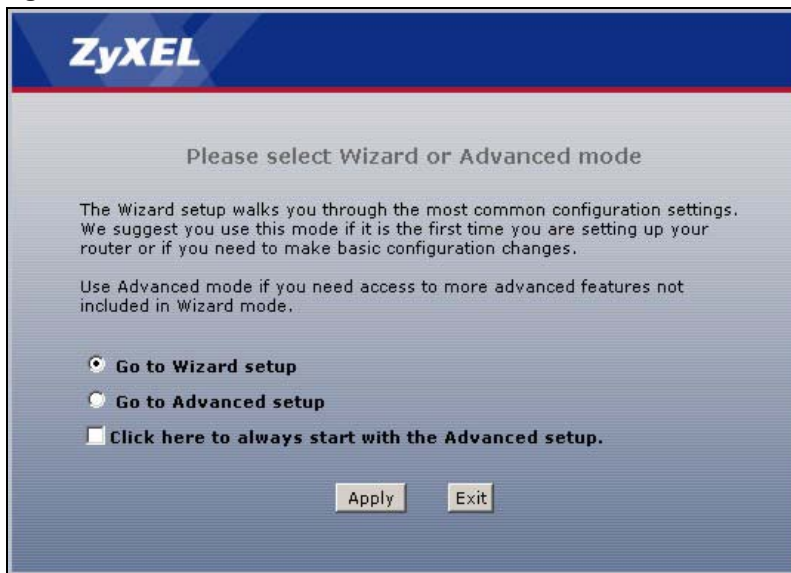
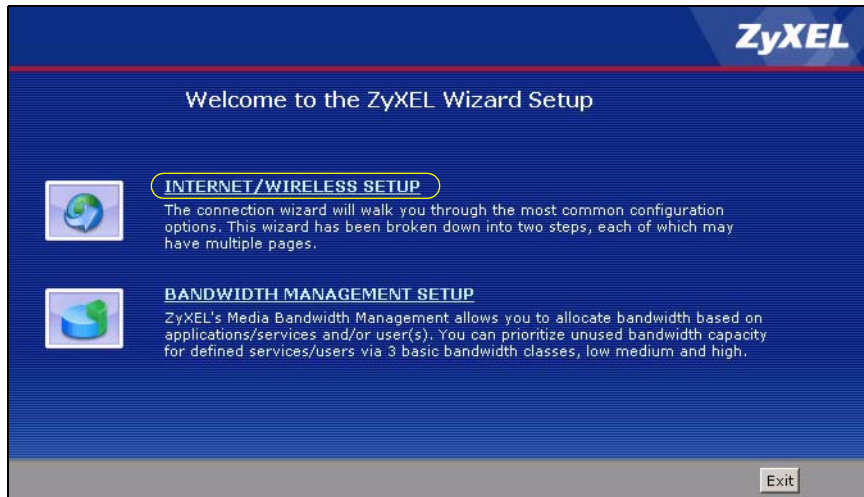
3 The wizard attempts to detect which WAN connection type you are using.

If the wizard detects your connection type and your ISP uses PPPoE or PPPoA, go to [Section 3.2.1 on page 58](#). The screen varies depending on the connection type you use.

If the wizard does not detect a connection type and the following screen appears (see [Figure 17 on page 57](#)), check your hardware connections and click **Restart the Internet/Wireless Setup Wizard** to have the ZyXEL Device detect your connection again.

Figure 17 Auto Detection: No DSL Connection

If the wizard still cannot detect a connection type and the following screen appears (see [Figure 18 on page 58](#)), click **Next** and refer to [Section 3.2.2 on page 58](#) on how to configure the ZyXEL Device for Internet access manually.

Figure 18 Auto Detection: Failed

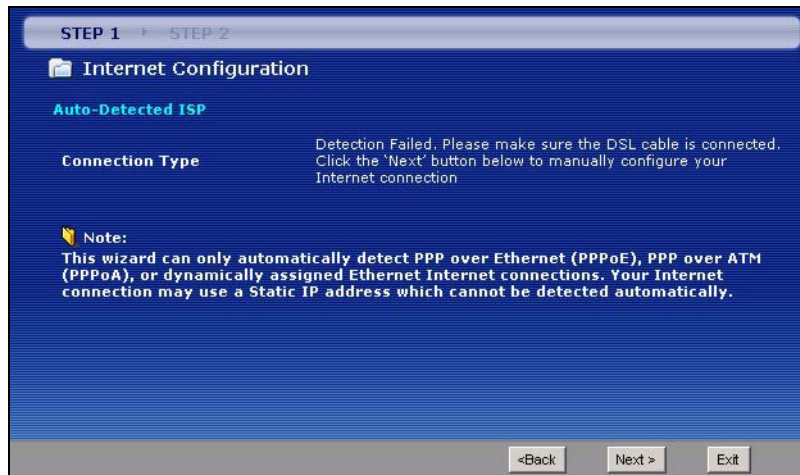

3.2.1 Automatic Detection

- 1 If you have a PPPoE or PPPoA connection, a screen displays prompting you to enter your Internet account information. Enter the username, password and/or service name exactly as provided.
- 2 Click **Next** and see [Section 3.3 on page 63](#) for wireless connection wizard setup.

Figure 19 Auto-Detection: PPPoE

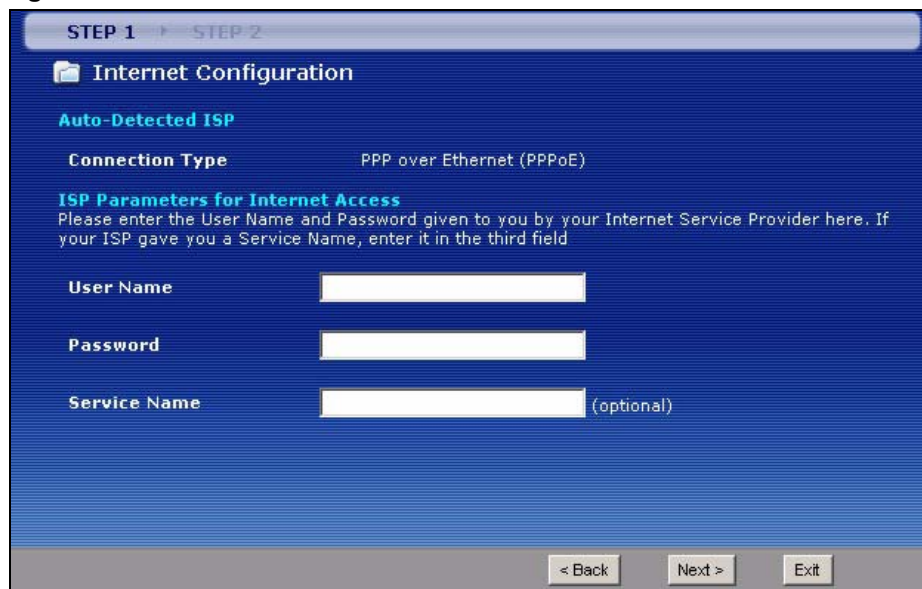

3.2.2 Manual Configuration

- 1 If the ZyXEL Device fails to detect your DSL connection type, enter the Internet access information given to you by your ISP exactly in the wizard screen. If not given, leave the fields set to the default.

Figure 20 Internet Access Wizard Setup: ISP Parameters

STEP 1 | **STEP 2**

Internet Configuration

ISP Parameters for Internet Access

Please verify the following settings with your Internet Service Provider (ISP). Your ISP may have given you a welcome letter or network setup letter including this information.

Mode
 Select 'Routing' (default) if your ISP allows multiple computers to share an Internet account. Otherwise, select 'Bridge' mode.

Encapsulation
 Select the encapsulation method used by your ISP. Your ISP may list 'ENET ENCAP' as 'Static IP' or 'Dynamic IP'.

Multiplexing
 Select the multiplexing type used by your ISP.

Virtual Circuit ID

VPI
VCI

Select the VPI (Virtual Path Identifier) and VCI (Virtual Channel Identifier) used by your ISP. The valid range for the VPI is 0 to 255 and VCI is 32 to 65535.

< Back Next > Exit

The following table describes the fields in this screen.

Table 8 Internet Access Wizard Setup: ISP Parameters

LABEL	DESCRIPTION
Mode	From the Mode drop-down list box, select Routing (default) if your ISP allows multiple computers to share an Internet account. Otherwise select Bridge .
Encapsulation	Select the encapsulation type your ISP uses from the Encapsulation drop-down list box. Choices vary depending on what you select in the Mode field. If you select Bridge in the Mode field, select either PPPoA or RFC 1483 . If you select Routing in the Mode field, select PPPoA , RFC 1483 , ENET ENCAP or PPPoE .
Multiplexing	Select the multiplexing method used by your ISP from the Multiplex drop-down list box either VC-based or LLC-based.
Virtual Circuit ID	VPI (Virtual Path Identifier) and VCI (Virtual Channel Identifier) define a virtual circuit. Refer to the appendix for more information.
VPI	Enter the VPI assigned to you. This field may already be configured.
VCI	Enter the VCI assigned to you. This field may already be configured.
Back	Click Back to go back to the previous screen.
Next	Click Next to continue to the next wizard screen. The next wizard screen you see depends on what protocol you chose above.
Exit	Click Exit to close the wizard screen without saving your changes.

- 2 The next wizard screen varies depending on what mode and encapsulation type you use. All screens shown are with routing mode. Configure the fields and click **Next** to continue. See [Section 3.3 on page 63](#) for wireless connection wizard setup

Figure 21 Internet Connection with PPPoE

STEP 1 > STEP 2

Internet Configuration

ISP Parameters for Internet Access
Please enter the User Name and Password given to you by your Internet Service Provider here. If your ISP gave you a Service Name, enter it in the third field

User Name

Password

Service Name (optional)

Note:
Device is automatically configured to obtain an IP address automatically. The ISP will assign you a different one each time you connect to the Internet.

< Back Apply Exit

The following table describes the fields in this screen.

Table 9 Internet Connection with PPPoE

LABEL	DESCRIPTION
User Name	Enter the user name exactly as your ISP assigned. If assigned a name in the form user@domain where domain identifies a service name, then enter both components exactly as given.
Password	Enter the password associated with the user name above.
Service Name	Type the name of your PPPoE service here.
Back	Click Back to go back to the previous wizard screen.
Apply	Click Apply to save your changes back to the ZyXEL Device.
Exit	Click Exit to close the wizard screen without saving your changes.

Figure 22 Internet Connection with RFC 1483

STEP 1 > STEP 2

Internet Configuration

ISP Parameters for Internet Access

IP Address

< Back Next > Exit

The following table describes the fields in this screen.

Table 10 Internet Connection with RFC 1483

LABEL	DESCRIPTION
IP Address	This field is available if you select Routing in the Mode field. Type your ISP assigned IP address in this field.
Back	Click Back to go back to the previous wizard screen.
Next	Click Next to continue to the next wizard screen.
Exit	Click Exit to close the wizard screen without saving your changes.

Figure 23 Internet Connection with ENET ENCAP



The following table describes the fields in this screen.

Table 11 Internet Connection with ENET ENCAP

LABEL	DESCRIPTION
Obtain an IP Address Automatically	A static IP address is a fixed IP that your ISP gives you. A dynamic IP address is not fixed; the ISP assigns you a different one each time you connect to the Internet. Select Obtain an IP Address Automatically if you have a dynamic IP address.
Static IP Address	Select Static IP Address if your ISP gives you a fixed IP address.
IP Address	Enter your ISP assigned IP address.
Subnet Mask	Enter a subnet mask in dotted decimal notation. Refer to the appendices to calculate a subnet mask If you are implementing subnetting.
Gateway IP address	You must specify a gateway IP address (supplied by your ISP) when you use ENET ENCAP in the Encapsulation field in the previous screen.
First DNS Server	Enter the IP addresses of the DNS servers. The DNS servers are passed to the DHCP clients along with the IP address and the subnet mask.

Table 11 Internet Connection with ENET ENCAP (continued)

LABEL	DESCRIPTION
Second DNS Server	As above.
Back	Click Back to go back to the previous wizard screen.
Apply	Click Apply to save your changes back to the ZyXEL Device.
Exit	Click Exit to close the wizard screen without saving your changes.

Figure 24 Internet Connection with PPPoA

STEP 1 | STEP 2

Internet Configuration

ISP Parameters for Internet Access
Please enter the User Name and Password given to you by your Internet Service Provider here

User Name

Password

Note:
Device is automatically configured to obtain an IP address automatically. The ISP will assign you a different one each time you connect to the Internet.

< Back Apply Exit

The following table describes the fields in this screen.

Table 12 Internet Connection with PPPoA

LABEL	DESCRIPTION
User Name	Enter the login name that your ISP gives you.
Password	Enter the password associated with the user name above.
Back	Click Back to go back to the previous wizard screen.
Apply	Click Apply to save your changes back to the ZyXEL Device.
Exit	Click Exit to close the wizard screen without saving your changes.

- If the user name and/or password you entered for PPPoE or PPPoA connection are not correct, the screen displays as shown next. Click **Back to Username and Password setup** to go back to the screen where you can modify them.

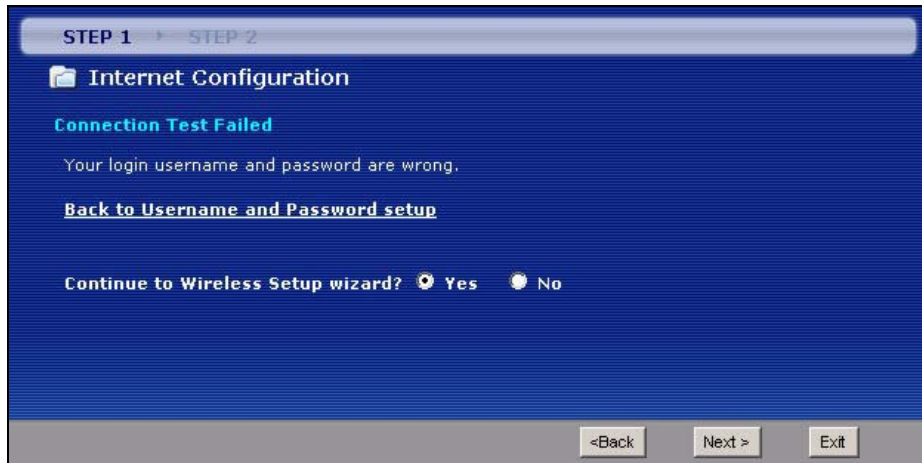
Figure 25 Connection Test Failed-1

- If the following screen displays, check if your account is activated or click **Restart the Internet/Wireless Setup Wizard** to verify your Internet access settings.

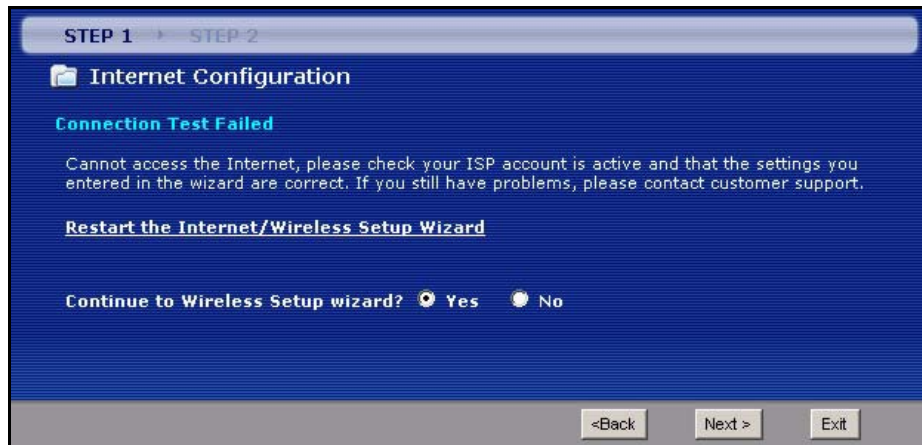
Figure 26 Connection Test Failed-2.

3.3 Wireless Connection Wizard Setup

After you configure the Internet access information, use the following screens to set up your wireless LAN. This section is available on the wireless devices only.

- 1 Select **Yes** and click **Next** to configure wireless settings. Otherwise, select **No** and skip to Step 6.

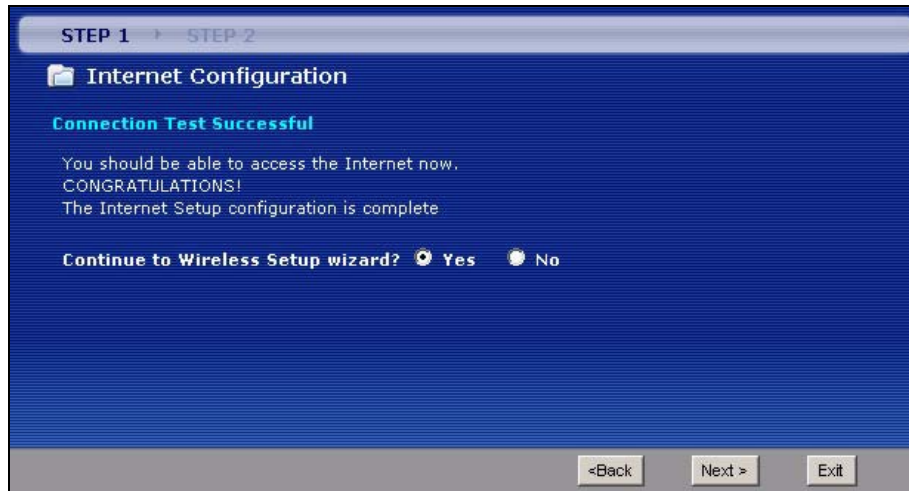
Figure 27 Connection Test Successful

2 Use this screen to activate the wireless LAN and OTIST. Click **Next** to continue.

Figure 28 Wireless LAN Setup Wizard 1

The following table describes the labels in this screen.

Table 13 Wireless LAN Setup Wizard 1

LABEL	DESCRIPTION
Active	Select the check box to turn on the wireless LAN.
Enable OTIST	Select the check box to enable OTIST if you want to transfer your ZyXEL Device's SSID and WPA-PSK security settings to wireless clients that support OTIST and are within transmission range. You must also activate and start OTIST on the wireless client at the same time. The process takes three minutes to complete. Note: Enable OTIST only if your wireless clients support WPA and OTIST.
Setup Key	Type an OTIST Setup Key of up to eight ASCII characters in length. Be sure to use the same OTIST Setup Key on the ZyXEL Device and wireless clients.
Back	Click Back to display the previous screen.
Next	Click Next to proceed to the next screen.
Exit	Click Exit to close the wizard screen without saving.

3 Configure your wireless settings in this screen. Click **Next**.

Figure 29 Wireless LAN Setup Wizard 2

STEP 1 → STEP 2

Wireless LAN

Wireless

Network Name (SSID)
Give your network a name. You will search for this name from your wireless clients.

Channel Selection
Your router can use one of several channels. You should use the default channel unless other wireless networks nearby use the same channel.

Security
Use this option if you would prefer to create your own key. WPA is stronger than WEP but not all devices are compatible with WPA.

< Back Next > Exit

The following table describes the labels in this screen.

Table 14 Wireless LAN Setup Wizard 2

LABEL	DESCRIPTION
Network Name(SSID)	Enter a descriptive name (up to 32 printable 7-bit ASCII characters) for the wireless LAN. If you change this field on the ZyXEL Device, make sure all wireless stations use the same SSID in order to access the network.
Channel Selection	The range of radio frequencies used by IEEE 802.11b/g wireless devices is called a channel. Select a channel ID that is not already in use by a neighboring device.
Security	<p>Select Automatically assign a WPA key (Recommended) to have the ZyXEL Device create a pre-shared key (WPA-PSK) automatically only if your wireless clients support WPA and OTIST. This option is available only when you enable OTIST in the previous wizard screen.</p> <p>Select Manually assign a WPA-PSK key to configure a pre-shared key (WPA-PSK). Choose this option only if your wireless clients support WPA. See Section 3.3.1 on page 66 for more information.</p> <p>Select Manually assign a WEP key to configure a WEP Key. See Section 3.3.2 on page 67 for more information.</p> <p>Select Disable wireless security to have no wireless LAN security configured and your network is accessible to any wireless networking device that is within range.</p> <p>Note: If you enable OTIST in the previous wizard screen but select Disable wireless security here, the ZyXEL Device still creates a pre-shared key (WPA-PSK) automatically.</p> <p>If you enable OTIST and select Manually assign a WEP key, the ZyXEL Device will replace the WEP key with a WPA-PSK.</p>
Back	Click Back to display the previous screen.
Next	Click Next to proceed to the next screen.
Exit	Click Exit to close the wizard screen without saving.

Note: The wireless stations and ZyXEL Device must use the same SSID, channel ID and WEP encryption key (if WEP is enabled), WPA-PSK (if WPA-PSK is enabled) for wireless communication.

- This screen varies depending on the security mode you selected in the previous screen. Fill in the field (if available) and click **Next**.

3.3.1 Manually assign a WPA-PSK key

Choose **Manually assign a WPA-PSK key** in the Wireless LAN setup screen to set up a **Pre-Shared Key**.

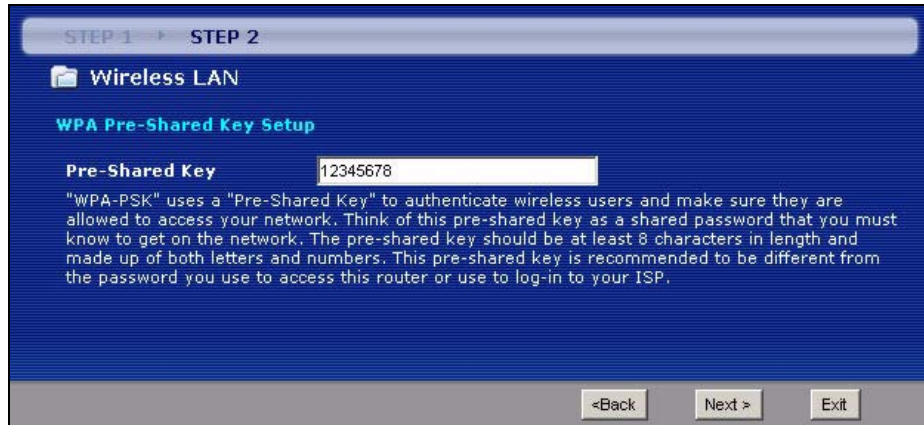
Figure 30 Manually assign a WPA key

The following table describes the labels in this screen.

Table 15 Manually assign a WPA key

LABEL	DESCRIPTION
Pre-Shared Key	Type from 8 to 63 case-sensitive ASCII characters. You can set up the most secure wireless connection by configuring WPA in the wireless LAN screens. You need to configure an authentication server to do this.
Back	Click Back to display the previous screen.
Next	Click Next to proceed to the next screen.
Exit	Click Exit to close the wizard screen without saving.

3.3.2 Manually assign a WEP key

Choose **Manually assign a WEP key** to setup WEP Encryption parameters.

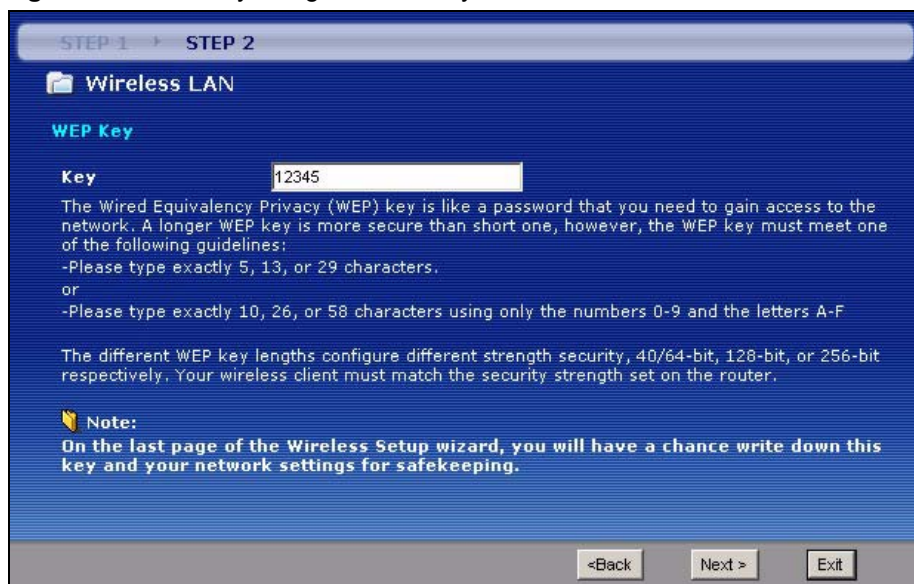
Figure 31 Manually assign a WEP key

The following table describes the labels in this screen.

Table 16 Manually assign a WEP key

LABEL	DESCRIPTION
Key	The WEP keys are used to encrypt data. Both the ZyXEL Device and the wireless stations must use the same WEP key for data transmission. Enter any 5, 13 or 29 ASCII characters or 10, 26 or 58 hexadecimal characters ("0-9", "A-F") for a 64-bit, 128-bit or 256-bit WEP key respectively.
Back	Click Back to display the previous screen.
Next	Click Next to proceed to the next screen.
Exit	Click Exit to close the wizard screen without saving.

5 Click **Apply** to save your wireless LAN settings.

Figure 32 Wireless LAN Setup 3

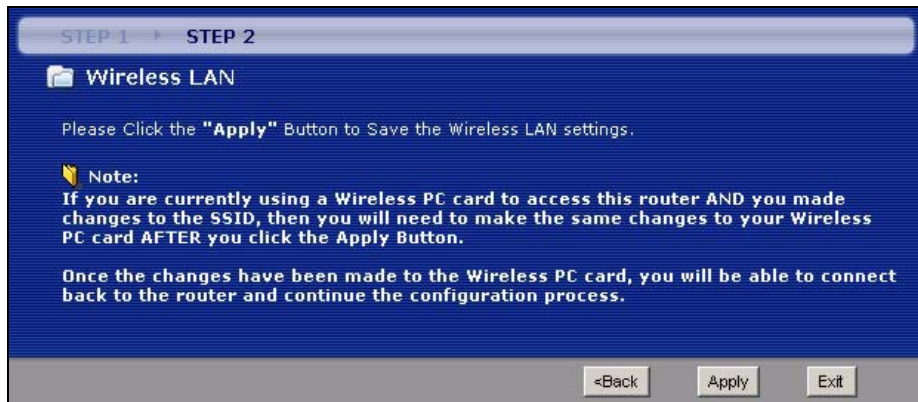

6 Use the read-only summary table to check whether what you have configured is correct. Click **Finish** to complete and save the wizard setup.

Figure 33 Internet Access and WLAN Wizard Setup Complete

- 7 Launch your web browser and navigate to www.zyxel.com. Internet access is just the beginning. Refer to the rest of this guide for more detailed information on the complete range of ZyXEL Device features. If you cannot access the Internet, open the web configurator again to confirm that the Internet settings you configured in the wizard setup are correct.

CHAPTER 4

Bandwidth Management Wizard

This chapter shows you how to configure basic bandwidth management using the wizard screens.

4.1 Introduction

Bandwidth management allows you to control the amount of bandwidth going out through the ZyXEL Device's WAN port and prioritize the distribution of the bandwidth according to service bandwidth requirements. This helps keep one service from using all of the available bandwidth and shutting out other users.

4.2 Predefined Media Bandwidth Management Services

The following is a description of the services that you can select and to which you can apply media bandwidth management using the wizard screens.

Table 17 Media Bandwidth Management Setup: Services

SERVICE	DESCRIPTION
Xbox Live	This is Microsoft's online gaming service that lets you play multiplayer Xbox games on the Internet via broadband technology. Xbox Live uses port 3074.
VoIP (SIP)	Sending voice signals over the Internet is called Voice over IP or VoIP. Session Initiated Protocol (SIP) is an internationally recognized standard for implementing VoIP. SIP is an application-layer control (signaling) protocol that handles the setting up, altering and tearing down of voice and multimedia sessions over the Internet. SIP is transported primarily over UDP but can also be transported over TCP, using the default port number 5060.
FTP	File Transfer Program enables fast transfer of files, including large files that may not be possible by e-mail. FTP uses port number 21.
E-Mail	Electronic mail consists of messages sent through a computer network to specific groups or individuals. Here are some default ports for e-mail: POP3 - port 110 IMAP - port 143 SMTP - port 25 HTTP - port 80

Table 17 Media Bandwidth Management Setup: Services (continued)

SERVICE	DESCRIPTION
eMule	These programs use advanced file sharing applications relying on central servers to search for files. They use default port 4662.
WWW	The World Wide Web (WWW) is an Internet system to distribute graphical, hyper-linked information, based on Hyper Text Transfer Protocol (HTTP) - a client/server protocol for the World Wide Web. The Web is not synonymous with the Internet; rather, it is just one service on the Internet. Other services on the Internet include Internet Relay Chat and Newsgroups. The Web is accessed through use of a browser.

4.3 Bandwidth Management Wizard Setup

- 1 After you enter the admin password to access the web configurator, select **Go to Wizard setup** and click **Apply**. Otherwise, click the wizard icon () in the top right corner of the web configurator to display the wizard main screen.

Figure 34 Select a Mode

- 2 Click **BANDWIDTH MANAGEMENT SETUP** to configure the system for Internet access and wireless connection.

Figure 35 Wizard: Welcome

- 3 Activate bandwidth management and select to allocate bandwidth to packets based on the service requirements.

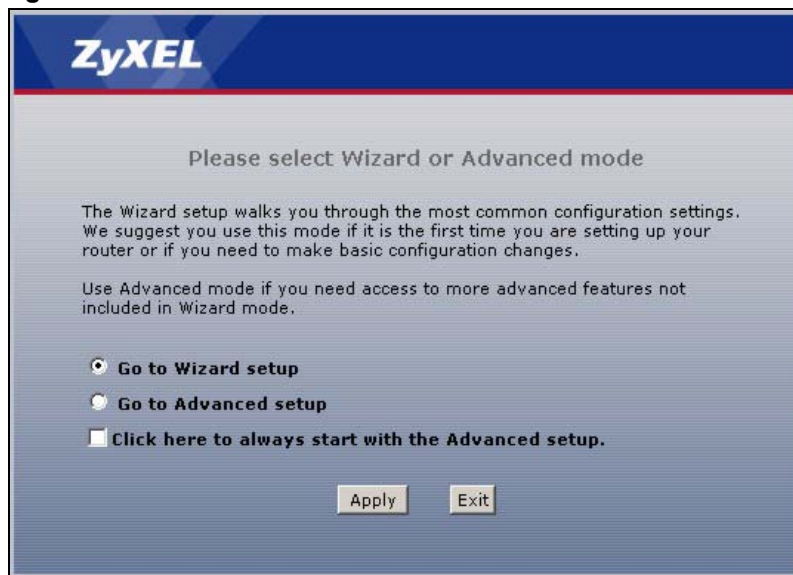
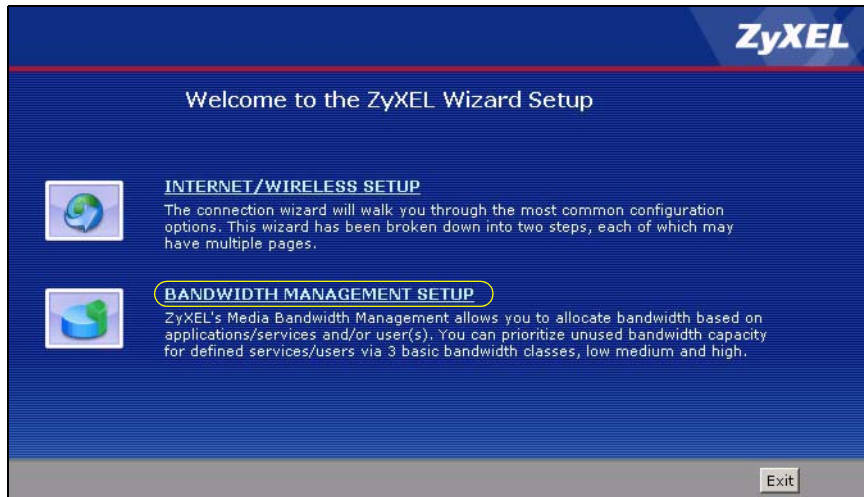
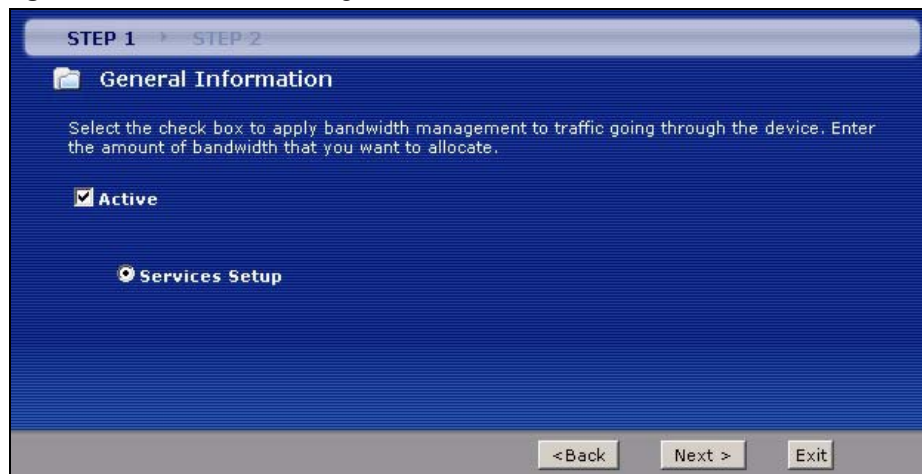
Figure 36 Bandwidth Management Wizard: General Information

The following fields describe the label in this screen.

Table 18 Bandwidth Management Wizard: General Information

LABEL	DESCRIPTION
Active	Select the Active check box to have the ZyXEL Device apply bandwidth management to traffic going out through the ZyXEL Device's port(s). Select Services Setup to allocate bandwidth based on the service requirements.
Back	Click Back to display the previous screen.
Next	Click Next to proceed to the next screen.
Exit	Click Exit to close the wizard screen without saving.

- 4 Use the second wizard screen to select the services that you want to apply bandwidth management and select the priorities that you want to apply to the services listed.

Figure 37 Bandwidth Management Wizard: Configuration

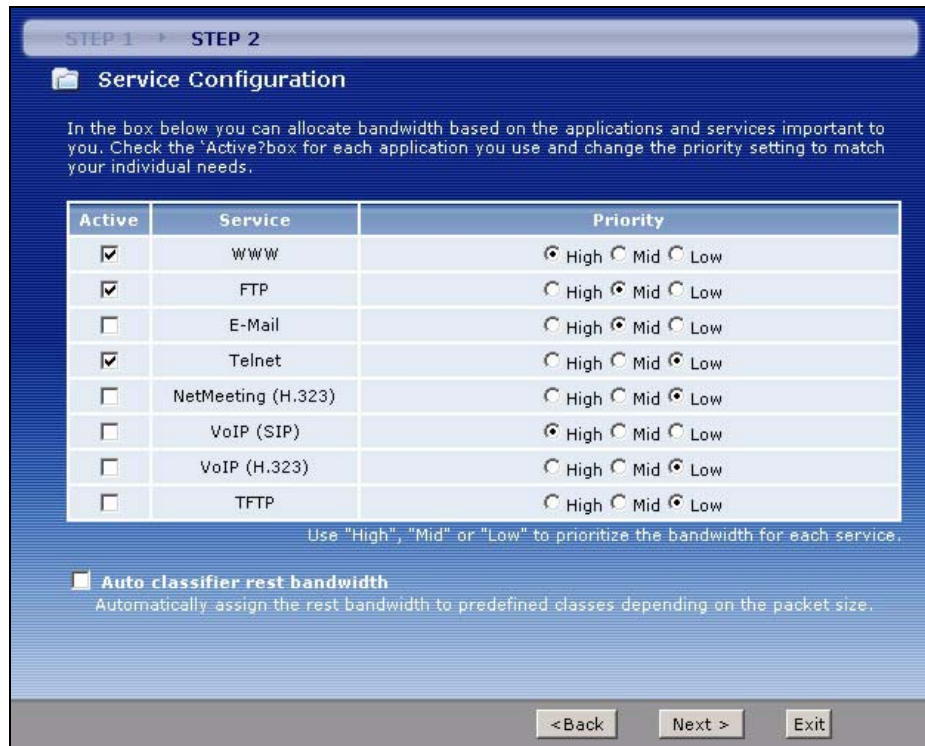

The following table describes the labels in this screen.

Table 19 Bandwidth Management Wizard: Configuration

LABEL	DESCRIPTION
Active	Select an entry's Active check box to turn on bandwidth management for the service/application.
Service	These fields display the services names.
Priority	Select High , Mid or Low priority for each service to have your ZyXEL Device use a priority for traffic that matches that service. A service with High priority is given as much bandwidth as it needs. If you select services as having the same priority, then bandwidth is divided equally amongst those services. Services not specified in bandwidth management are allocated bandwidth after all specified services receive their bandwidth requirements. If the rules set up in this wizard are changed in Advanced > Bandwidth MGMT > Rule Setup , then the service priority radio button will be set to User Configured . The Advanced > Bandwidth MGMT > Rule Setup screen allows you to edit these rule configurations.
Auto classifier rest bandwidth	Select Auto classifier rest bandwidth to automatically allocate unbudgeted or unused bandwidth to services based on the packet type.
Back	Click Back to go back to the previous wizard screen.
Apply	Click Apply to save your changes back to the ZyXEL Device.
Exit	Click Exit to close the wizard screen without saving your changes.

- 5 Follow the on-screen instructions and click **Finish** to complete the wizard setup and save your configuration.

Figure 38 Bandwidth Management Wizard: Complete



CHAPTER 5

WAN Setup

This chapter describes how to configure WAN settings.

5.1 WAN Overview

A WAN (Wide Area Network) is an outside connection to another network or the Internet.

5.1.1 Encapsulation

Be sure to use the encapsulation method required by your ISP. The ZyXEL Device supports the following methods.

5.1.1.1 ENET ENCAP

The MAC Encapsulated Routing Link Protocol (ENET ENCAP) is only implemented with the IP network protocol. IP packets are routed between the Ethernet interface and the WAN interface and then formatted so that they can be understood in a bridged environment. For instance, it encapsulates routed Ethernet frames into bridged ATM cells. ENET ENCAP requires that you specify a gateway IP address in the **ENET ENCAP Gateway** field in the second wizard screen. You can get this information from your ISP.

5.1.1.2 PPP over Ethernet

PPPoE (Point-to-Point Protocol over Ethernet) provides access control and billing functionality in a manner similar to dial-up services using PPP. PPPoE is an IETF standard (RFC 2516) specifying how a personal computer (PC) interacts with a broadband modem (DSL, cable, wireless, etc.) connection.

For the service provider, PPPoE offers an access and authentication method that works with existing access control systems (for example RADIUS).

One of the benefits of PPPoE is the ability to let you access one of multiple network services, a function known as dynamic service selection. This enables the service provider to easily create and offer new IP services for individuals.

Operationally, PPPoE saves significant effort for both you and the ISP or carrier, as it requires no specific configuration of the broadband modem at the customer site.

By implementing PPPoE directly on the ZyXEL Device (rather than individual computers), the computers on the LAN do not need PPPoE software installed, since the ZyXEL Device does that part of the task. Furthermore, with NAT, all of the LANs' computers will have access.

5.1.1.3 PPPoA

PPPoA stands for Point to Point Protocol over ATM Adaptation Layer 5 (AAL5). A PPPoA connection functions like a dial-up Internet connection. The ZyXEL Device encapsulates the PPP session based on RFC1483 and sends it through an ATM PVC (Permanent Virtual Circuit) to the Internet Service Provider's (ISP) DSLAM (digital access multiplexer). Please refer to RFC 2364 for more information on PPPoA. Refer to RFC 1661 for more information on PPP.

5.1.1.4 RFC 1483

RFC 1483 describes two methods for Multiprotocol Encapsulation over ATM Adaptation Layer 5 (AAL5). The first method allows multiplexing of multiple protocols over a single ATM virtual circuit (LLC-based multiplexing) and the second method assumes that each protocol is carried over a separate ATM virtual circuit (VC-based multiplexing). Please refer to the RFC for more detailed information.

5.1.2 Multiplexing

There are two conventions to identify what protocols the virtual circuit (VC) is carrying. Be sure to use the multiplexing method required by your ISP.

5.1.2.1 VC-based Multiplexing

In this case, by prior mutual agreement, each protocol is assigned to a specific virtual circuit; for example, VC1 carries IP, etc. VC-based multiplexing may be dominant in environments where dynamic creation of large numbers of ATM VCs is fast and economical.

5.1.2.2 LLC-based Multiplexing

In this case one VC carries multiple protocols with protocol identifying information being contained in each packet header. Despite the extra bandwidth and processing overhead, this method may be advantageous if it is not practical to have a separate VC for each carried protocol, for example, if charging heavily depends on the number of simultaneous VCs.

5.1.3 Encapsulation and Multiplexing Scenarios

For Internet access you should use the encapsulation and multiplexing methods used by your ISP. Consult your telephone company for information on encapsulation and multiplexing methods for LAN-to-LAN applications, for example between a branch office and corporate headquarters. There must be prior agreement on encapsulation and multiplexing methods

because they cannot be automatically determined. What method(s) you use also depends on how many VCs you have and how many different network protocols you need. The extra overhead that ENET ENCAP encapsulation entails makes it a poor choice in a LAN-to-LAN application. Here are some examples of more suitable combinations in such an application.

5.1.3.1 Scenario 1: One VC, Multiple Protocols

PPPoA (RFC-2364) encapsulation with **VC-based** multiplexing is the best combination because no extra protocol identifying headers are needed. The **PPP** protocol already contains this information.

5.1.3.2 Scenario 2: One VC, One Protocol (IP)

Selecting **RFC-1483** encapsulation with **VC-based** multiplexing requires the least amount of overhead (0 octets). However, if there is a potential need for multiple protocol support in the future, it may be safer to select **PPPoA** encapsulation instead of **RFC-1483**, so you do not need to reconfigure either computer later.

5.1.3.3 Scenario 3: Multiple VCs

If you have an equal number (or more) of VCs than the number of protocols, then select **RFC-1483** encapsulation and **VC-based** multiplexing.

5.1.4 VPI and VCI

Be sure to use the correct Virtual Path Identifier (VPI) and Virtual Channel Identifier (VCI) numbers assigned to you. The valid range for the VPI is 0 to 255 and for the VCI is 32 to 65535 (0 to 31 is reserved for local management of ATM traffic). Please see the appendix for more information.

5.1.5 IP Address Assignment

A static IP is a fixed IP that your ISP gives you. A dynamic IP is not fixed; the ISP assigns you a different one each time. The Single User Account feature can be enabled or disabled if you have either a dynamic or static IP. However the encapsulation method assigned influences your choices for IP address and ENET ENCAP gateway.

5.1.5.1 IP Assignment with PPPoA or PPPoE Encapsulation

If you have a dynamic IP, then the **IP Address** and **ENET ENCAP Gateway** fields are not applicable (N/A). If you have a static IP, then you *only* need to fill in the **IP Address** field and *not* the **ENET ENCAP Gateway** field.

5.1.5.2 IP Assignment with RFC 1483 Encapsulation

In this case the IP Address Assignment *must* be static with the same requirements for the **IP Address** and **ENET ENCAP Gateway** fields as stated above.

5.1.5.3 IP Assignment with ENET ENCAP Encapsulation

In this case you can have either a static or dynamic IP. For a static IP you must fill in all the **IP Address** and **ENET ENCAP Gateway** fields as supplied by your ISP. However for a dynamic IP, the ZyXEL Device acts as a DHCP client on the WAN port and so the **IP Address** and **ENET ENCAP Gateway** fields are not applicable (N/A) as the DHCP server assigns them to the ZyXEL Device.

5.1.6 Nailed-Up Connection (PPP)

A nailed-up connection is a dial-up line where the connection is always up regardless of traffic demand. The ZyXEL Device does two things when you specify a nailed-up connection. The first is that idle timeout is disabled. The second is that the ZyXEL Device will try to bring up the connection when turned on and whenever the connection is down. A nailed-up connection can be very expensive for obvious reasons.

Do not specify a nailed-up connection unless your telephone company offers flat-rate service or you need a constant connection and the cost is of no concern

5.1.7 NAT

NAT (Network Address Translation - NAT, RFC 1631) is the translation of the IP address of a host in a packet, for example, the source address of an outgoing packet, used within one network to a different IP address known within another network.

5.2 Metric

The metric represents the "cost of transmission". A router determines the best route for transmission by choosing a path with the lowest "cost". RIP routing uses hop count as the measurement of cost, with a minimum of "1" for directly connected networks. The number must be between "1" and "15"; a number greater than "15" means the link is down. The smaller the number, the lower the "cost".

The metric sets the priority for the ZyXEL Device's routes to the Internet. If any two of the default routes have the same metric, the ZyXEL Device uses the following pre-defined priorities:

- Normal route: designated by the ISP (see [Section 5.5 on page 82](#))
- Traffic-redirect route (see [Section 5.7 on page 90](#))
- WAN-backup route, also called dial-backup (see [Section 5.8 on page 91](#))

For example, if the normal route has a metric of "1" and the traffic-redirect route has a metric of "2" and dial-backup route has a metric of "3", then the normal route acts as the primary default route. If the normal route fails to connect to the Internet, the ZyXEL Device tries the traffic-redirect route next. In the same manner, the ZyXEL Device uses the dial-backup route if the traffic-redirect route also fails.

If you want the dial-backup route to take first priority over the traffic-redirect route or even the normal route, all you need to do is set the dial-backup route's metric to "1" and the others to "2" (or greater).

IP Policy Routing overrides the default routing behavior and takes priority over all of the routes mentioned above.

5.3 Traffic Shaping

Traffic Shaping is an agreement between the carrier and the subscriber to regulate the average rate and fluctuations of data transmission over an ATM network. This agreement helps eliminate congestion, which is important for transmission of real time data such as audio and video connections.

Peak Cell Rate (PCR) is the maximum rate at which the sender can send cells. This parameter may be lower (but not higher) than the maximum line speed. 1 ATM cell is 53 bytes (424 bits), so a maximum speed of 832Kbps gives a maximum PCR of 1962 cells/sec. This rate is not guaranteed because it is dependent on the line speed.

Sustained Cell Rate (SCR) is the mean cell rate of each bursty traffic source. It specifies the maximum average rate at which cells can be sent over the virtual connection. SCR may not be greater than the PCR.

Maximum Burst Size (MBS) is the maximum number of cells that can be sent at the PCR. After MBS is reached, cell rates fall below SCR until cell rate averages to the SCR again. At this time, more cells (up to the MBS) can be sent at the PCR again.

If the PCR, SCR or MBS is set to the default of "0", the system will assign a maximum value that correlates to your upstream line rate.

The following figure illustrates the relationship between PCR, SCR and MBS.

Figure 39 Example of Traffic Shaping

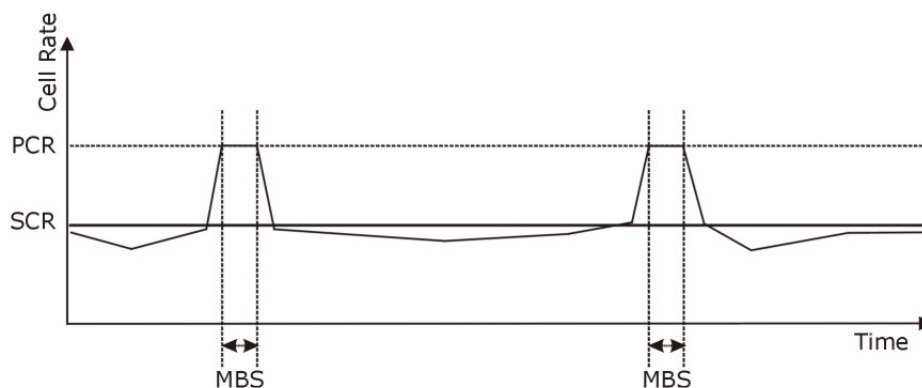

5.3.1 ATM Traffic Classes

These are the basic ATM traffic classes defined by the ATM Forum Traffic Management 4.0 Specification.

5.3.1.1 Constant Bit Rate (CBR)

Constant Bit Rate (CBR) provides fixed bandwidth that is always available even if no data is being sent. CBR traffic is generally time-sensitive (doesn't tolerate delay). CBR is used for connections that continuously require a specific amount of bandwidth. A PCR is specified and if traffic exceeds this rate, cells may be dropped. Examples of connections that need CBR would be high-resolution video and voice.

5.3.1.2 Variable Bit Rate (VBR)

The Variable Bit Rate (VBR) ATM traffic class is used with bursty connections. Connections that use the Variable Bit Rate (VBR) traffic class can be grouped into real time (VBR-RT) or non-real time (VBR-nRT) connections.

The VBR-RT (real-time Variable Bit Rate) type is used with bursty connections that require closely controlled delay and delay variation. It also provides a fixed amount of bandwidth (a PCR is specified) but is only available when data is being sent. An example of a VBR-RT connection would be video conferencing. Video conferencing requires real-time data transfers and the bandwidth requirement varies in proportion to the video image's changing dynamics.

The VBR-nRT (non real-time Variable Bit Rate) type is used with bursty connections that do not require closely controlled delay and delay variation. It is commonly used for "bursty" traffic typical on LANs. PCR and MBS define the burst levels, SCR defines the minimum level. An example of a VBR-nRT connection would be non-time sensitive data file transfers.

5.3.1.3 Unspecified Bit Rate (UBR)

The Unspecified Bit Rate (UBR) ATM traffic class is for bursty data transfers. However, UBR doesn't guarantee any bandwidth and only delivers traffic when the network has spare bandwidth. An example application is background file transfer.

5.4 Zero Configuration Internet Access

Once you turn on and connect the ZyXEL Device to a telephone jack, it automatically detects the Internet connection settings (such as the VCI/VPI numbers and the encapsulation method) from the ISP and makes the necessary configuration changes. In cases where additional account information (such as an Internet account user name and password) is required or the ZyXEL Device cannot connect to the ISP, you will be redirected to web screen(s) for information input or troubleshooting.

Zero configuration for Internet access is disable when

- the ZyXEL Device is in bridge mode
- you set the ZyXEL Device to use a static (fixed) WAN IP address.

5.5 Internet Connection

To change your ZyXEL Device's WAN Internet access settings, click **Network > WAN**. The screen differs by the encapsulation.

See [Section 5.1 on page 76](#) for more information.

Figure 40 Internet Connection (PPPoE)

The following table describes the labels in this screen.

Table 20 Internet Connection

LABEL	DESCRIPTION
General	
Name	Enter the name of your Internet Service Provider, e.g., MyISP. This information is for identification purposes only.
Mode	Select Routing (default) from the drop-down list box if your ISP allows multiple computers to share an Internet account. Otherwise select Bridge .

Table 20 Internet Connection (continued)

LABEL	DESCRIPTION
Encapsulation	Select the method of encapsulation used by your ISP from the drop-down list box. Choices vary depending on the mode you select in the Mode field. If you select Bridge in the Mode field, select either PPPoA or RFC 1483 . If you select Routing in the Mode field, select PPPoA , RFC 1483 , ENET ENCAP or PPPoE .
User Name	(PPPoA and PPPoE encapsulation only) Enter the user name exactly as your ISP assigned. If assigned a name in the form user@domain where domain identifies a service name, then enter both components exactly as given.
Password	(PPPoA and PPPoE encapsulation only) Enter the password associated with the user name above.
Service Name	(PPPoE only) Type the name of your PPPoE service here.
Multiplexing	Select the method of multiplexing used by your ISP from the drop-down list. Choices are VC or LLC .
Virtual Circuit ID	VPI (Virtual Path Identifier) and VCI (Virtual Channel Identifier) define a virtual circuit. Refer to the appendix for more information.
VPI	The valid range for the VPI is 0 to 255. Enter the VPI assigned to you.
VCI	The valid range for the VCI is 32 to 65535 (0 to 31 is reserved for local management of ATM traffic). Enter the VCI assigned to you.
IP Address	This option is available if you select Routing in the Mode field. A static IP address is a fixed IP that your ISP gives you. A dynamic IP address is not fixed; the ISP assigns you a different one each time you connect to the Internet. If you use the encapsulation type except RFC 1483 , select Obtain an IP Address Automatically when you have a dynamic IP address; otherwise select Static IP Address and type your ISP assigned IP address in the IP Address field below. If you use RFC 1483 , enter the IP address given by your ISP in the IP Address field.
Subnet Mask (ENET ENCAP encapsulation only)	Enter a subnet mask in dotted decimal notation. Refer to the appendices to calculate a subnet mask If you are implementing subnetting.
Gateway IP address (ENET ENCAP encapsulation only)	You must specify a gateway IP address (supplied by your ISP) when you select ENET ENCAP in the Encapsulation field
Connection (PPPoA and PPPoE encapsulation only)	
Nailed-Up Connection	Select Nailed-Up Connection when you want your connection up all the time. The ZyXEL Device will try to bring up the connection automatically if it is disconnected.
Connect on Demand	Select Connect on Demand when you don't want the connection up all the time and specify an idle time-out in the Max Idle Timeout field.
Max Idle Timeout	Specify an idle time-out in the Max Idle Timeout field when you select Connect on Demand . The default setting is 0, which means the Internet session will not timeout.
Apply	Click Apply to save the changes.

Table 20 Internet Connection (continued)

LABEL	DESCRIPTION
Cancel	Click Cancel to begin configuring this screen afresh.
Advanced Setup	Click this button to display the Advanced Internet Connection Setup screen and edit more details of your WAN setup.

5.5.1 Configuring Advanced Internet Connection Setup

To edit your ZyXEL Device's advanced WAN settings, click the **Advanced Setup** button in the **Internet Connection** screen. The screen appears as shown.

Figure 41 Advanced Internet Connection Setup

The following table describes the labels in this screen.

Table 21 Advanced Internet Connection Setup

LABEL	DESCRIPTION
RIP & Multicast Setup	
RIP Direction	Select the RIP direction from None , Both , In Only and Out Only .
RIP Version	Select the RIP version from RIP-1 , RIP-2B and RIP-2M .
Multicast	IGMP (Internet Group Multicast Protocol) is a network-layer protocol used to establish membership in a multicast group. The ZyXEL Device supports both IGMP version 1 (IGMP-v1) and IGMP-v2 . Select None to disable it.
ATM QoS	

Table 21 Advanced Internet Connection Setup (continued)

LABEL	DESCRIPTION
ATM QoS Type	Select CBR (Continuous Bit Rate) to specify fixed (always-on) bandwidth for voice or data traffic. Select UBR (Unspecified Bit Rate) for applications that are non-time sensitive, such as e-mail. Select VBR-nRT (Variable Bit Rate-non Real Time) or VBR-RT (Variable Bit Rate-Real Time) for bursty traffic and bandwidth sharing with other applications.
Peak Cell Rate	Divide the DSL line rate (bps) by 424 (the size of an ATM cell) to find the Peak Cell Rate (PCR). This is the maximum rate at which the sender can send cells. Type the PCR here.
Sustain Cell Rate	The Sustain Cell Rate (SCR) sets the average cell rate (long-term) that can be transmitted. Type the SCR, which must be less than the PCR. Note that system default is 0 cells/sec.
Maximum Burst Size	Maximum Burst Size (MBS) refers to the maximum number of cells that can be sent at the peak rate. Type the MBS, which is less than 65535.
Zero Configuration	This feature is not applicable/available when you configure the ZyXEL Device to use a static WAN IP address or in bridge mode. Select Yes to set the ZyXEL Device to automatically detect the Internet connection settings (such as the VCI/VPI numbers and the encapsulation method) from the ISP and make the necessary configuration changes. Select No to disable this feature. You must manually configure the ZyXEL Device for Internet access.
PPPoE Passthrough (PPPoE encapsulation only)	This field is available when you select PPPoE encapsulation. In addition to the ZyXEL Device's built-in PPPoE client, you can enable PPPoE pass through to allow up to ten hosts on the LAN to use PPPoE client software on their computers to connect to the ISP via the ZyXEL Device. Each host can have a separate account and a public WAN IP address. PPPoE pass through is an alternative to NAT for application where NAT is not appropriate. Disable PPPoE pass through if you do not need to allow hosts on the LAN to use PPPoE client software on their computers to connect to the ISP.
Back	Click Back to return to the previous screen.
Apply	Click Apply to save the changes.
Cancel	Click Cancel to begin configuring this screen afresh.

5.6 Configuring More Connections

This section describes the protocol-independent parameters for a remote network. They are required for placing calls to a remote gateway and the network behind it across a WAN connection. When you use the **WAN > Internet Connection** screen to set up Internet access, you are configuring the first WAN connection.

Click **Network > WAN > More Connections** to display the screen as shown next.

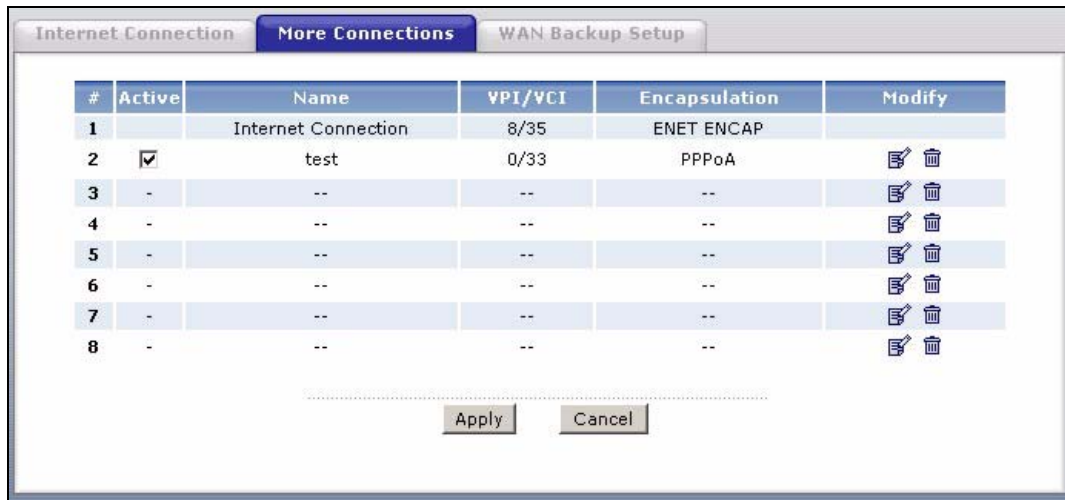
Figure 42 More Connections

The following table describes the labels in this screen.

Table 22 More Connections

LABEL	DESCRIPTION
#	This is the index number of a connection.
Active	This display whether this connection is activated. Clear the check box to disable the connection. Select the check box to enable it.
Name	This is the descriptive name for this connection.
VPI/VCI	This is the VPI and VCI values used for this connection.
Encapsulation	This is the method of encapsulation used for this connection.
Modify	The first (ISP) connection is read-only in this screen. Use the WAN > Internet Connection screen to edit it. Click the edit icon to go to the screen where you can edit the connection. Click the delete icon to remove an existing connection. You cannot remove the first connection.
Apply	Click Apply to save the changes.
Cancel	Click Cancel to begin configuring this screen afresh.

5.6.1 More Connections Edit

Click the edit icon in the **More Connections** screen to configure a connection.

Figure 43 More Connections Edit

General

Active

Name: ChangeMe

Mode: Routing

Encapsulation: PPPoE

User Name: _____

Password: _____

Service Name: _____

Multiplexing: VC

VPI: 0

VCI: 33

IP Address

Obtain an IP Address Automatically

Static IP Address

IP Address: 0.0.0.0

Subnet Mask: 0.0.0.0

Gateway IP Address: 0.0.0.0

Connection

Nailed-Up Connection

Connect on Demand

Max Idle timeout: 0 sec

NAT

None

SUA Only [Edit](#)

Back Apply Cancel Advanced Setup

The following table describes the labels in this screen.

Table 23 More Connections Edit

LABEL	DESCRIPTION
Active	Select the check box to activate or clear the check box to deactivate this connection.
Name	Enter a unique, descriptive name of up to 13 ASCII characters for this connection.
Mode	Select Routing from the drop-down list box if your ISP allows multiple computers to share an Internet account. If you select Bridge , the ZyXEL Device will forward any packet that it does not route to this remote node; otherwise, the packets are discarded.
Encapsulation	Select the method of encapsulation used by your ISP from the drop-down list box. Choices are PPPoA , RFC 1483 , ENET ENCAP or PPPoE .

Table 23 More Connections Edit (continued)

LABEL	DESCRIPTION
User Name	(PPPoA and PPPoE encapsulation only) Enter the user name exactly as your ISP assigned. If assigned a name in the form user@domain where domain identifies a service name, then enter both components exactly as given.
Password	(PPPoA and PPPoE encapsulation only) Enter the password associated with the user name above.
Service Name	(PPPoE only) Type the name of your PPPoE service here.
Multiplexing	<p>Select the method of multiplexing used by your ISP from the drop-down list. Choices are VC or LLC.</p> <p>By prior agreement, a protocol is assigned a specific virtual circuit, for example, VC1 will carry IP. If you select VC, specify separate VPI and VCI numbers for each protocol.</p> <p>For LLC-based multiplexing or PPP encapsulation, one VC carries multiple protocols with protocol identifying information being contained in each packet header. In this case, only one set of VPI and VCI numbers need be specified for all protocols.</p>
VPI	The valid range for the VPI is 0 to 255. Enter the VPI assigned to you.
VCI	The valid range for the VCI is 32 to 65535 (0 to 31 is reserved for local management of ATM traffic). Enter the VCI assigned to you.
IP Address	<p>This option is available if you select Routing in the Mode field.</p> <p>A static IP address is a fixed IP that your ISP gives you. A dynamic IP address is not fixed; the ISP assigns you a different one each time you connect to the Internet.</p> <p>If you use the encapsulation type except RFC 1483, select Obtain an IP Address Automatically when you have a dynamic IP address; otherwise select Static IP Address and type your ISP assigned IP address in the IP Address field below.</p> <p>If you use RFC 1483, enter the IP address given by your ISP in the IP Address field.</p>
Subnet Mask	<p>Enter a subnet mask in dotted decimal notation.</p> <p>Refer to the appendices to calculate a subnet mask If you are implementing subnetting.</p>
Gateway IP address	Specify a gateway IP address (supplied by your ISP).
Connection	
Nailed-Up Connection	Select Nailed-Up Connection when you want your connection up all the time. The ZyXEL Device will try to bring up the connection automatically if it is disconnected.
Connect on Demand	Select Connect on Demand when you don't want the connection up all the time and specify an idle time-out in the Max Idle Timeout field.
Max Idle Timeout	Specify an idle time-out in the Max Idle Timeout field when you select Connect on Demand . The default setting is 0, which means the Internet session will not timeout.
NAT	<p>SUA only is available only when you select Routing in the Mode field.</p> <p>Select SUA Only if you have one public IP address and want to use NAT. Click Edit to go to the Port Forwarding screen to edit a server mapping set.</p> <p>Otherwise, select None to disable NAT.</p>
Back	Click Back to return to the previous screen.
Apply	Click Apply to save the changes.

Table 23 More Connections Edit (continued)

LABEL	DESCRIPTION
Cancel	Click Cancel to begin configuring this screen afresh.
Advanced Setup	Click this button to display the More Connections Advanced screen and edit more details of your WAN setup.

5.6.2 Configuring More Connections Advanced Setup

To edit your ZyXEL Device's advanced WAN settings, click the **Advanced Setup** button in the **More Connections Edit** screen. The screen appears as shown.

Figure 44 More Connections Advanced Setup

The following table describes the labels in this screen.

Table 24 More Connections Advanced Setup

LABEL	DESCRIPTION
RIP & Multicast Setup	
RIP Direction	Select the RIP direction from None , Both , In Only and Out Only .
RIP Version	Select the RIP version from RIP-1 , RIP-2B and RIP-2M .
Multicast	IGMP (Internet Group Multicast Protocol) is a network-layer protocol used to establish membership in a multicast group. The ZyXEL Device supports both IGMP version 1 (IGMP-v1) and IGMP-v2 . Select None to disable it.
ATM QoS	
ATM QoS Type	Select CBR (Continuous Bit Rate) to specify fixed (always-on) bandwidth for voice or data traffic. Select UBR (Unspecified Bit Rate) for applications that are non-time sensitive, such as e-mail. Select VBR-nRT (Variable Bit Rate-non Real Time) or VBR-RT (Variable Bit Rate-Real Time) for bursty traffic and bandwidth sharing with other applications.

Table 24 More Connections Advanced Setup (continued)

LABEL	DESCRIPTION
Peak Cell Rate	Divide the DSL line rate (bps) by 424 (the size of an ATM cell) to find the Peak Cell Rate (PCR). This is the maximum rate at which the sender can send cells. Type the PCR here.
Sustain Cell Rate	The Sustain Cell Rate (SCR) sets the average cell rate (long-term) that can be transmitted. Type the SCR, which must be less than the PCR. Note that system default is 0 cells/sec.
Maximum Burst Size	Maximum Burst Size (MBS) refers to the maximum number of cells that can be sent at the peak rate. Type the MBS, which is less than 65535.
Back	Click Back to return to the previous screen.
Apply	Click Apply to save the changes.
Cancel	Click Cancel to begin configuring this screen afresh.

5.7 Traffic Redirect

Traffic redirect forwards traffic to a backup gateway when the ZyXEL Device cannot connect to the Internet. An example is shown in the figure below.

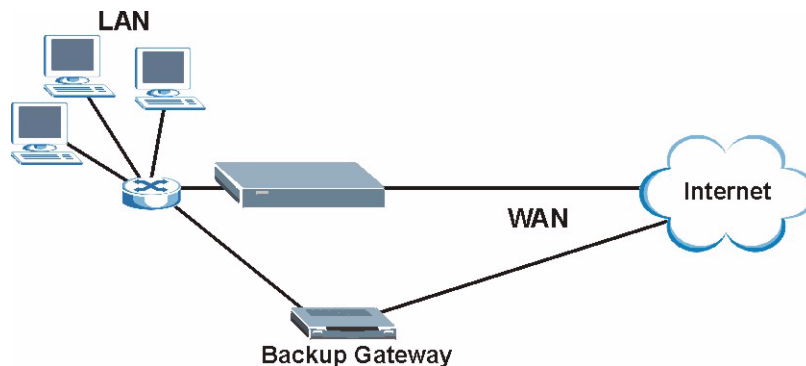
Figure 45 Traffic Redirect Example

The following network topology allows you to avoid triangle route security issues when the backup gateway is connected to the LAN. Use IP alias to configure the LAN into two or three logical networks with the ZyXEL Device itself as the gateway for each LAN network. Put the protected LAN in one subnet (Subnet 1 in the following figure) and the backup gateway in another subnet (Subnet 2). Configure filters that allow packets from the protected LAN (Subnet 1) to the backup gateway (Subnet 2).

Figure 46 Traffic Redirect LAN Setup

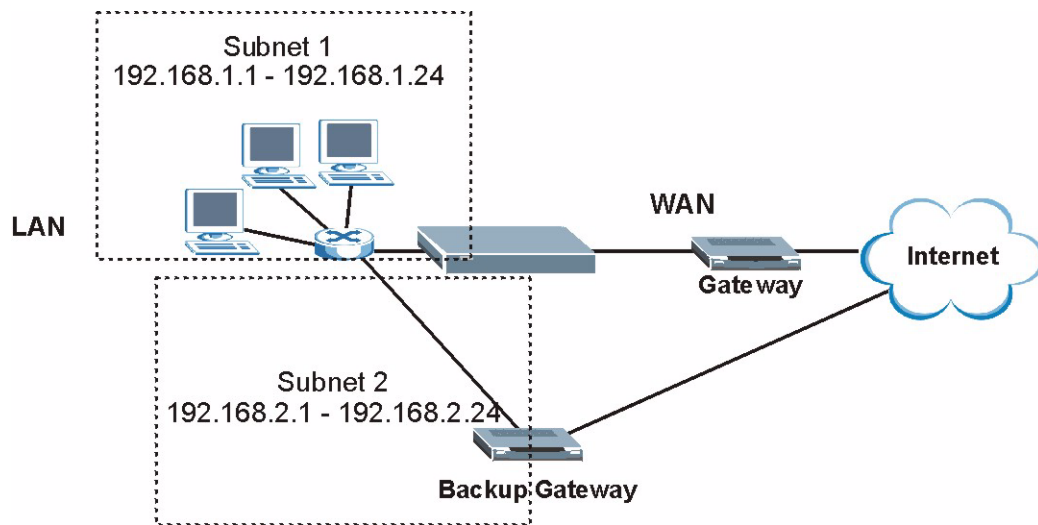

5.8 Configuring WAN Backup

To change your ZyXEL Device's WAN backup settings, click **Network > WAN > WAN Backup Setup**. The screen appears as shown.

Figure 47 WAN Backup Setup

The screenshot shows the 'WAN Backup Setup' configuration window. It has three tabs: 'Internet Connection', 'More Connections', and 'WAN Backup Setup' (which is selected). The window is divided into two main sections: 'WAN Backup Setup' and 'Traffic Redirect'.

WAN Backup Setup Section:

- Backup Type: DSL Link (dropdown menu)
- Check WAN IP Address 1: 0.0.0.0 (text input)
- Check WAN IP Address 2: 0.0.0.0 (text input)
- Check WAN IP Address 3: 0.0.0.0 (text input)
- Fail Tolerance: 0 (text input)
- Recovery Interval: 0 sec (text input)
- Timeout: 0 sec (text input)

Traffic Redirect Section:

- Active Traffic Redirect: (checkbox)
- Metric: 15 (text input)
- Backup Gateway: 0.0.0.0 (text input)

At the bottom of the window, there are 'Apply' and 'Cancel' buttons.

The following table describes the labels in this screen.

Table 25 WAN Backup Setup

LABEL	DESCRIPTION
Backup Type	Select the method that the ZyXEL Device uses to check the DSL connection. Select DSL Link to have the ZyXEL Device check if the connection to the DSLAM is up. Select ICMP to have the ZyXEL Device periodically ping the IP addresses configured in the Check WAN IP Address fields.
Check WAN IP Address1-3	Configure this field to test your ZyXEL Device's WAN accessibility. Type the IP address of a reliable nearby computer (for example, your ISP's DNS server address). Note: If you activate either traffic redirect or dial backup, you must configure at least one IP address here. When using a WAN backup connection, the ZyXEL Device periodically pings the addresses configured here and uses the other WAN backup connection (if configured) if there is no response.
Fail Tolerance	Type the number of times (2 recommended) that your ZyXEL Device may ping the IP addresses configured in the Check WAN IP Address field without getting a response before switching to a WAN backup connection (or a different WAN backup connection).
Recovery Interval	When the ZyXEL Device is using a lower priority connection (usually a WAN backup connection), it periodically checks to whether or not it can use a higher priority connection. Type the number of seconds (30 recommended) for the ZyXEL Device to wait between checks. Allow more time if your destination IP address handles lots of traffic.
Timeout	Type the number of seconds (3 recommended) for your ZyXEL Device to wait for a ping response from one of the IP addresses in the Check WAN IP Address field before timing out the request. The WAN connection is considered "down" after the ZyXEL Device times out the number of times specified in the Fail Tolerance field. Use a higher value in this field if your network is busy or congested.
Traffic Redirect	Traffic redirect forwards traffic to a backup gateway when the ZyXEL Device cannot connect to the Internet.
Active Traffic Redirect	Select this check box to have the ZyXEL Device use traffic redirect if the normal WAN connection goes down. Note: If you activate traffic redirect, you must configure at least one Check WAN IP Address.
Metric	This field sets this route's priority among the routes the ZyXEL Device uses. The metric represents the "cost of transmission". A router determines the best route for transmission by choosing a path with the lowest "cost". RIP routing uses hop count as the measurement of cost, with a minimum of "1" for directly connected networks. The number must be between "1" and "15"; a number greater than "15" means the link is down. The smaller the number, the lower the "cost".
Backup Gateway	Type the IP address of your backup gateway in dotted decimal notation. The ZyXEL Device automatically forwards traffic to this IP address if the ZyXEL Device's Internet connection terminates.
Apply	Click Apply to save the changes.
Cancel	Click Cancel to begin configuring this screen afresh.

CHAPTER 6

LAN Setup

This chapter describes how to configure LAN settings.

6.1 LAN Overview

A Local Area Network (LAN) is a shared communication system to which many computers are attached. A LAN is a computer network limited to the immediate area, usually the same building or floor of a building. The LAN screens can help you configure a LAN DHCP server and manage IP addresses.

See [Section 6.3 on page 100](#) to configure the LAN screens.

6.1.1 LANs, WANs and the ZyXEL Device

The actual physical connection determines whether the ZyXEL Device ports are LAN or WAN ports. There are two separate IP networks, one inside the LAN network and the other outside the WAN network as shown next.

Figure 48 LAN and WAN IP Addresses

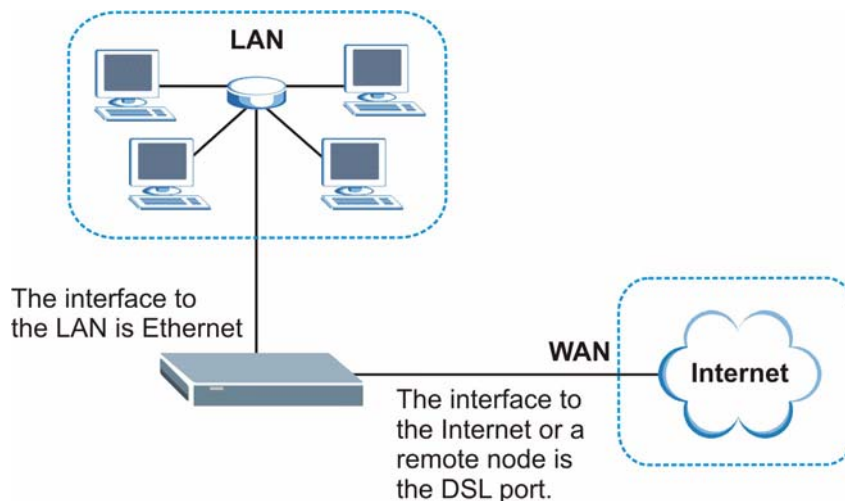

6.1.2 DHCP Setup

DHCP (Dynamic Host Configuration Protocol, RFC 2131 and RFC 2132) allows individual clients to obtain TCP/IP configuration at start-up from a server. You can configure the ZyXEL Device as a DHCP server or disable it. When configured as a server, the ZyXEL Device provides the TCP/IP configuration for the clients. If you turn DHCP service off, you must have another DHCP server on your LAN, or else the computer must be manually configured.

6.1.2.1 IP Pool Setup

The ZyXEL Device is pre-configured with a pool of IP addresses for the DHCP clients (DHCP Pool). See the product specifications in the appendices. Do not assign static IP addresses from the DHCP pool to your LAN computers.

6.1.3 DNS Server Address

DNS (Domain Name System) is for mapping a domain name to its corresponding IP address and vice versa. The DNS server is extremely important because without it, you must know the IP address of a machine before you can access it. The DNS server addresses that you enter in the DHCP setup are passed to the client machines along with the assigned IP address and subnet mask.

There are two ways that an ISP disseminates the DNS server addresses. The first is for an ISP to tell a customer the DNS server addresses, usually in the form of an information sheet, when s/he signs up. If your ISP gives you the DNS server addresses, enter them in the **DNS Server** fields in **DHCP Setup**, otherwise, leave them blank.

Some ISP's choose to pass the DNS servers using the DNS server extensions of PPP IPCP (IP Control Protocol) after the connection is up. If your ISP did not give you explicit DNS servers, chances are the DNS servers are conveyed through IPCP negotiation. The ZyXEL Device supports the IPCP DNS server extensions through the DNS proxy feature.

If the **Primary** and **Secondary DNS Server** fields in the **DHCP Setup** screen are not specified, for instance, left as **0.0.0.0**, the ZyXEL Device tells the DHCP clients that it itself is the DNS server. When a computer sends a DNS query to the ZyXEL Device, the ZyXEL Device forwards the query to the real DNS server learned through IPCP and relays the response back to the computer.

Please note that DNS proxy works only when the ISP uses the IPCP DNS server extensions. It does not mean you can leave the DNS servers out of the DHCP setup under all circumstances. If your ISP gives you explicit DNS servers, make sure that you enter their IP addresses in the **DHCP Setup** screen. This way, the ZyXEL Device can pass the DNS servers to the computers and the computers can query the DNS server directly without the ZyXEL Device's intervention.

6.1.4 DNS Server Address Assignment

Use DNS (Domain Name System) to map a domain name to its corresponding IP address and vice versa. The DNS server is extremely important because without it, you must know the IP address of a computer before you can access it.

There are two ways that an ISP disseminates the DNS server addresses.

- The ISP tells you the DNS server addresses, usually in the form of an information sheet, when you sign up. If your ISP gives you DNS server addresses, enter them in the DNS Server fields in the **DHCP Setup** screen.
- The ZyXEL Device acts as a DNS proxy when the **Primary** and **Secondary DNS Server** fields are left as **0.0.0.0** in the **DHCP Setup** screen.

6.2 LAN TCP/IP

The ZyXEL Device has built-in DHCP server capability that assigns IP addresses and DNS servers to systems that support DHCP client capability.

6.2.1 IP Address and Subnet Mask

Similar to the way houses on a street share a common street name, so too do computers on a LAN share one common network number.

Where you obtain your network number depends on your particular situation. If the ISP or your network administrator assigns you a block of registered IP addresses, follow their instructions in selecting the IP addresses and the subnet mask.

If the ISP did not explicitly give you an IP network number, then most likely you have a single user account and the ISP will assign you a dynamic IP address when the connection is established. If this is the case, it is recommended that you select a network number from 192.168.0.0 to 192.168.255.0 and you must enable the Network Address Translation (NAT) feature of the ZyXEL Device. The Internet Assigned Number Authority (IANA) reserved this block of addresses specifically for private use; please do not use any other number unless you are told otherwise. Let's say you select 192.168.1.0 as the network number; which covers 254 individual addresses, from 192.168.1.1 to 192.168.1.254 (zero and 255 are reserved). In other words, the first three numbers specify the network number while the last number identifies an individual computer on that network.

Once you have decided on the network number, pick an IP address that is easy to remember, for instance, 192.168.1.1, for your ZyXEL Device, but make sure that no other device on your network is using that IP address.

The subnet mask specifies the network number portion of an IP address. Your ZyXEL Device will compute the subnet mask automatically based on the IP address that you entered. You don't need to change the subnet mask computed by the ZyXEL Device unless you are instructed to do otherwise.

6.2.1.1 Private IP Addresses

Every machine on the Internet must have a unique address. If your networks are isolated from the Internet, for example, only between your two branch offices, you can assign any IP addresses to the hosts without problems. However, the Internet Assigned Numbers Authority (IANA) has reserved the following three blocks of IP addresses specifically for private networks:

- 10.0.0.0 — 10.255.255.255
- 172.16.0.0 — 172.31.255.255
- 192.168.0.0 — 192.168.255.255

You can obtain your IP address from the IANA, from an ISP or it can be assigned from a private network. If you belong to a small organization and your Internet access is through an ISP, the ISP can provide you with the Internet addresses for your local networks. On the other hand, if you are part of a much larger organization, you should consult your network administrator for the appropriate IP addresses.

Note: Regardless of your particular situation, do not create an arbitrary IP address; always follow the guidelines above. For more information on address assignment, please refer to RFC 1597, *Address Allocation for Private Internets* and RFC 1466, *Guidelines for Management of IP Address Space*.

6.2.2 RIP Setup

RIP (Routing Information Protocol) allows a router to exchange routing information with other routers. The **RIP Direction** field controls the sending and receiving of RIP packets. When set to:

- **Both** - the ZyXEL Device will broadcast its routing table periodically and incorporate the RIP information that it receives.
- **In Only** - the ZyXEL Device will not send any RIP packets but will accept all RIP packets received.
- **Out Only** - the ZyXEL Device will send out RIP packets but will not accept any RIP packets received.
- **None** - the ZyXEL Device will not send any RIP packets and will ignore any RIP packets received.

The **Version** field controls the format and the broadcasting method of the RIP packets that the ZyXEL Device sends (it recognizes both formats when receiving). **RIP-1** is universally supported; but RIP-2 carries more information. RIP-1 is probably adequate for most networks, unless you have an unusual network topology.

Both **RIP-2B** and **RIP-2M** sends the routing data in RIP-2 format; the difference being that **RIP-2B** uses subnet broadcasting while **RIP-2M** uses multicasting.

6.2.3 Multicast

Traditionally, IP packets are transmitted in one of either two ways - Unicast (1 sender - 1 recipient) or Broadcast (1 sender - everybody on the network). Multicast delivers IP packets to a group of hosts on the network - not everybody and not just 1.

IGMP (Internet Group Multicast Protocol) is a network-layer protocol used to establish membership in a Multicast group - it is not used to carry user data. IGMP version 2 (RFC 2236) is an improvement over version 1 (RFC 1112) but IGMP version 1 is still in wide use. If you would like to read more detailed information about interoperability between IGMP version 2 and version 1, please see sections 4 and 5 of RFC 2236. The class D IP address is used to identify host groups and can be in the range 224.0.0.0 to 239.255.255.255. The address 224.0.0.0 is not assigned to any group and is used by IP multicast computers. The address 224.0.0.1 is used for query messages and is assigned to the permanent group of all IP hosts (including gateways). All hosts must join the 224.0.0.1 group in order to participate in IGMP. The address 224.0.0.2 is assigned to the multicast routers group.

The ZyXEL Device supports both IGMP version 1 (**IGMP-v1**) and IGMP version 2 (**IGMP-v2**). At start up, the ZyXEL Device queries all directly connected networks to gather group membership. After that, the ZyXEL Device periodically updates this information. IP multicasting can be enabled/disabled on the ZyXEL Device LAN and/or WAN interfaces in the web configurator (**LAN**; **WAN**). Select **None** to disable IP multicasting on these interfaces.

6.2.4 Any IP

Traditionally, you must set the IP addresses and the subnet masks of a computer and the ZyXEL Device to be in the same subnet to allow the computer to access the Internet (through the ZyXEL Device). In cases where your computer is required to use a static IP address in another network, you may need to manually configure the network settings of the computer every time you want to access the Internet via the ZyXEL Device.

With the Any IP feature and NAT enabled, the ZyXEL Device allows a computer to access the Internet without changing the network settings (such as IP address and subnet mask) of the computer, when the IP addresses of the computer and the ZyXEL Device are not in the same subnet. Whether a computer is set to use a dynamic or static (fixed) IP address, you can simply connect the computer to the ZyXEL Device and access the Internet.

The following figure depicts a scenario where a computer is set to use a static private IP address in the corporate environment. In a residential house where a ZyXEL Device is installed, you can still use the computer to access the Internet without changing the network settings, even when the IP addresses of the computer and the ZyXEL Device are not in the same subnet.

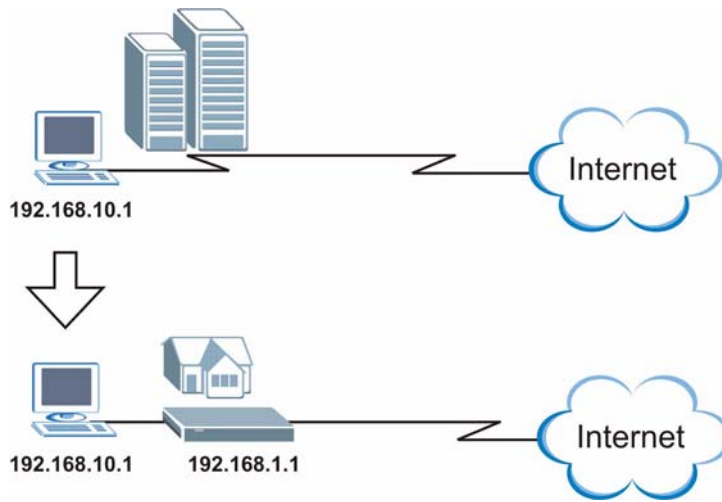
Figure 49 Any IP Example

The Any IP feature does not apply to a computer using either a dynamic IP address or a static IP address that is in the same subnet as the ZyXEL Device's IP address.

Note: You *must* enable NAT/SUA to use the Any IP feature on the ZyXEL Device.

6.2.4.1 How Any IP Works

Address Resolution Protocol (ARP) is a protocol for mapping an Internet Protocol address (IP address) to a physical machine address, also known as a Media Access Control or MAC address, on the local area network. IP routing table is defined on IP Ethernet devices (the ZyXEL Device) to decide which hop to use, to help forward data along to its specified destination.

The following lists out the steps taken, when a computer tries to access the Internet for the first time through the ZyXEL Device.

- 1** When a computer (which is in a different subnet) first attempts to access the Internet, it sends packets to its default gateway (which is not the ZyXEL Device) by looking at the MAC address in its ARP table.
- 2** When the computer cannot locate the default gateway, an ARP request is broadcast on the LAN.
- 3** The ZyXEL Device receives the ARP request and replies to the computer with its own MAC address.
- 4** The computer updates the MAC address for the default gateway to the ARP table. Once the ARP table is updated, the computer is able to access the Internet through the ZyXEL Device.
- 5** When the ZyXEL Device receives packets from the computer, it creates an entry in the IP routing table so it can properly forward packets intended for the computer.

After all the routing information is updated, the computer can access the ZyXEL Device and the Internet as if it is in the same subnet as the ZyXEL Device.

6.3 Configuring LAN IP

Click **LAN** to open the **IP** screen. See [Section 6.1 on page 94](#) for background information.

Figure 50 LAN IP

The following table describes the fields in this screen.

Table 26 LAN IP

LABEL	DESCRIPTION
TCP/IP	
IP Address	Enter the IP address of your ZyXEL Device in dotted decimal notation, for example, 192.168.1.1 (factory default).
IP Subnet Mask	Type the subnet mask assigned to you by your ISP (if given).
Apply	Click Apply to save your changes back to the ZyXEL Device.
Cancel	Click Cancel to begin configuring this screen afresh.
Advanced Setup	Click this button to display the Advanced LAN Setup screen and edit more details of your LAN setup.

6.3.1 Configuring Advanced LAN Setup

To edit your ZyXEL Device's advanced LAN settings, click the **Advanced Setup** button in the **LAN IP** screen. The screen appears as shown.

Figure 51 Advanced LAN Setup

The following table describes the labels in this screen.

Table 27 Advanced LAN Setup

LABEL	DESCRIPTION
RIP & Multicast Setup	
RIP Direction	Select the RIP direction from None , Both , In Only and Out Only .
RIP Version	Select the RIP version from RIP-1 , RIP-2B and RIP-2M .
Multicast	IGMP (Internet Group Multicast Protocol) is a network-layer protocol used to establish membership in a multicast group. The ZyXEL Device supports both IGMP version 1 (IGMP-v1) and IGMP-v2 . Select None to disable it.
Any IP Setup	Select the Active check box to enable the Any IP feature. This allows a computer to access the Internet without changing the network settings (such as IP address and subnet mask) of the computer, even when the IP addresses of the computer and the ZyXEL Device are not in the same subnet. When you disable the Any IP feature, only computers with dynamic IP addresses or static IP addresses in the same subnet as the ZyXEL Device's LAN IP address can connect to the ZyXEL Device or access the Internet through the ZyXEL Device.
Windows Networking (NetBIOS over TCP/IP)	NetBIOS (Network Basic Input/Output System) are TCP or UDP packets that enable a computer to connect to and communicate with a LAN. For some dial-up services such as PPPoE or PPTP, NetBIOS packets cause unwanted calls. However it may sometimes be necessary to allow NetBIOS packets to pass through to the WAN in order to find a computer on the WAN.
Allow between LAN and WAN	Select this check box to forward NetBIOS packets from the LAN to the WAN and from the WAN to the LAN. If your firewall is enabled with the default policy set to block WAN to LAN traffic, you also need to enable the default WAN to LAN firewall rule that forwards NetBIOS traffic. Clear this check box to block all NetBIOS packets going from the LAN to the WAN and from the WAN to the LAN.
Back	Click Back to return to the previous screen.
Apply	Click Apply to save the changes.
Cancel	Click Cancel to begin configuring this screen afresh.

6.4 DHCP Setup

Use this screen to configure the DNS server information that the ZyXEL Device sends to the DHCP client devices on the LAN.

Figure 52 DHCP Setup

The following table describes the labels in this screen.

Table 28 DHCP Setup

LABEL	DESCRIPTION
DHCP Setup	
DHCP	<p>If set to Server, your ZyXEL Device can assign IP addresses, an IP default gateway and DNS servers to Windows 95, Windows NT and other systems that support the DHCP client.</p> <p>If set to None, the DHCP server will be disabled.</p> <p>If set to Relay, the ZyXEL Device acts as a surrogate DHCP server and relays DHCP requests and responses between the remote server and the clients. Enter the IP address of the actual, remote DHCP server in the Remote DHCP Server field in this case.</p> <p>When DHCP is used, the following items need to be set:</p>
IP Pool Starting Address	This field specifies the first of the contiguous addresses in the IP address pool.
Pool Size	This field specifies the size, or count of the IP address pool.
Remote DHCP Server	If Relay is selected in the DHCP field above then enter the IP address of the actual remote DHCP server here.
DNS Server	
DNS Servers Assigned by DHCP Server	The ZyXEL Device passes a DNS (Domain Name System) server IP address to the DHCP clients.

Table 28 DHCP Setup

LABEL	DESCRIPTION
Primary DNS Server	This field is not available when you set DHCP to Relay .
Secondary DNS Server	Enter the IP addresses of the DNS servers. The DNS servers are passed to the DHCP clients along with the IP address and the subnet mask. If the fields are left as 0.0.0.0 , the ZyXEL Device acts as a DNS proxy and forwards the DHCP client's DNS query to the real DNS server learned through IPCP and relays the response back to the computer.
Apply	Click Apply to save your changes back to the ZyXEL Device.
Reset	Click Reset to begin configuring this screen afresh.

6.5 LAN Client List

This table allows you to assign IP addresses on the LAN to specific individual computers based on their MAC Addresses.

Every Ethernet device has a unique MAC (Media Access Control) address. The MAC address is assigned at the factory and consists of six pairs of hexadecimal characters, for example, 00:A0:C5:00:00:02.

To change your ZyXEL Device's static DHCP settings, click **Network > LAN > Client List**. The screen appears as shown.

Figure 53 LAN Client List

The screenshot displays the 'LAN Client List' configuration interface. At the top, there are navigation tabs: 'IP', 'DHCP Setup', 'Client List' (selected), and 'IP Alias'. Below the tabs, the 'DHCP Client Table' is shown. It includes input fields for 'IP Address' (0.0.0.0) and 'MAC Address' (00:00:00:00:00:00) with an 'Add' button. The table has the following columns: '#', 'Status', 'Host Name', 'IP Address', 'MAC Address', 'Reserve', and 'Modify'. The table contains three entries:

#	Status	Host Name	IP Address	MAC Address	Reserve	Modify
1		tw11947	192.168.1.33	00:00:E8:7C:14:80	<input type="checkbox"/>	
2			192.168.1.35	00:AC:10:01:23:45	<input checked="" type="checkbox"/>	
3			192.168.1.64	00:A0:C5:01:23:46	<input checked="" type="checkbox"/>	

At the bottom of the table, there are three buttons: 'Apply', 'Cancel', and 'Refresh'.

The following table describes the labels in this screen.

Table 29 LAN Client List

LABEL	DESCRIPTION
IP Address	Enter the IP address that you want to assign to the computer on your LAN with the MAC address specified below. The IP address should be within the range of IP addresses you specified in the DHCP Setup for the DHCP client.
MAC Address	Enter the MAC address of a computer on your LAN.
Add	Click Add to add a static DHCP entry.
#	This is the index number of the static IP table entry (row).
Status	This field displays whether the client is connected to the ZyXEL Device.
Host Name	This field displays the computer host name.
IP Address	This field displays the IP address relative to the # field listed above.
MAC Address	The MAC (Media Access Control) or Ethernet address on a LAN (Local Area Network) is unique to your computer (six pairs of hexadecimal notation). A network interface card such as an Ethernet adapter has a hardwired address that is assigned at the factory. This address follows an industry standard that ensures no other adapter has a similar address.
Reserve	Select the check box(es) in each entry to have the ZyXEL Device always assign the selected entry(ies)'s IP address(es) to the corresponding MAC address(es) (and host name(s)). You can select up to 32 entries in this table.
Modify	Click the modify icon to have the IP address field editable and change it.
Apply	Click Apply to save your changes back to the ZyXEL Device.
Cancel	Click Cancel to begin configuring this screen afresh.
Refresh	Click Refresh to reload the DHCP table.

6.6 LAN IP Alias

IP alias allows you to partition a physical network into different logical networks over the same Ethernet interface. The ZyXEL Device supports three logical LAN interfaces via its single physical Ethernet interface with the ZyXEL Device itself as the gateway for each LAN network.

When you use IP alias, you can also configure firewall rules to control access between the LAN's logical networks (subnets).

Note: Make sure that the subnets of the logical networks do not overlap.

The following figure shows a LAN divided into subnets A, B, and C.

Figure 54 Physical Network & Partitioned Logical Networks



To change your ZyXEL Device's IP alias settings, click **Network > LAN > IP Alias**. The screen appears as shown.

Figure 55 LAN IP Alias

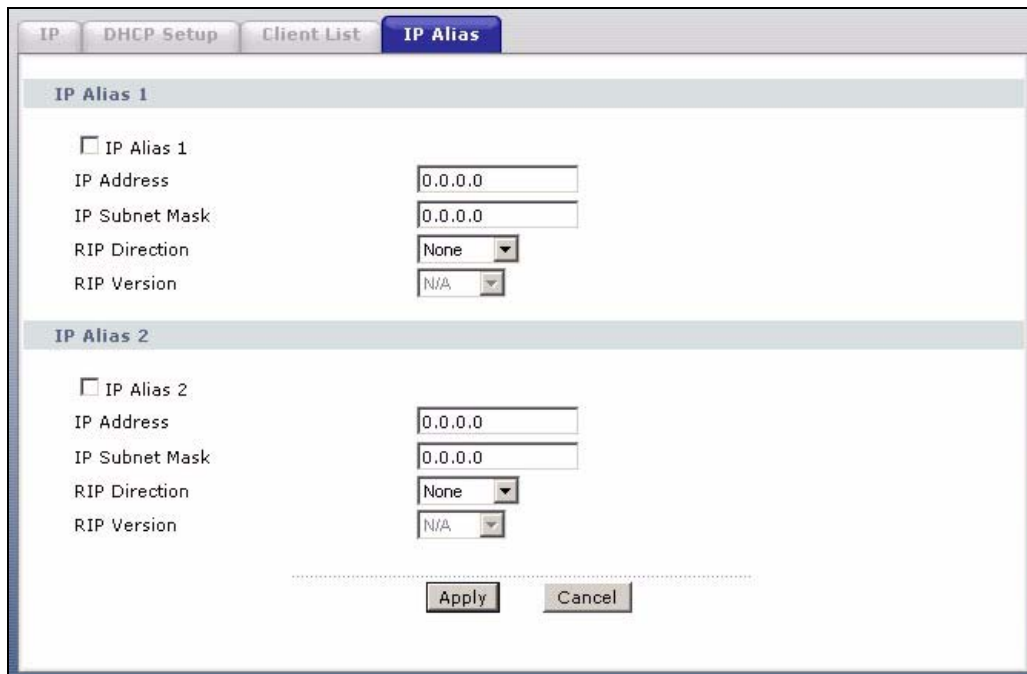

The following table describes the labels in this screen.

Table 30 LAN IP Alias

LABEL	DESCRIPTION
IP Alias 1, 2	Select the check box to configure another LAN network for the ZyXEL Device.
IP Address	Enter the IP address of your ZyXEL Device in dotted decimal notation. Alternatively, click the right mouse button to copy and/or paste the IP address.
IP Subnet Mask	Your ZyXEL Device will automatically calculate the subnet mask based on the IP address that you assign. Unless you are implementing subnetting, use the subnet mask computed by the ZyXEL Device.

Table 30 LAN IP Alias

LABEL	DESCRIPTION
RIP Direction	RIP (Routing Information Protocol, RFC 1058 and RFC 1389) allows a router to exchange routing information with other routers. The RIP Direction field controls the sending and receiving of RIP packets. Select the RIP direction from Both/In Only/Out Only/None . When set to Both or Out Only , the ZyXEL Device will broadcast its routing table periodically. When set to Both or In Only , it will incorporate the RIP information that it receives; when set to None , it will not send any RIP packets and will ignore any RIP packets received.
RIP Version	The RIP Version field controls the format and the broadcasting method of the RIP packets that the ZyXEL Device sends (it recognizes both formats when receiving). RIP-1 is universally supported but RIP-2 carries more information. RIP-1 is probably adequate for most networks, unless you have an unusual network topology. Both RIP-2B and RIP-2M sends the routing data in RIP-2 format; the difference being that RIP-2B uses subnet broadcasting while RIP-2M uses multicasting. Multicasting can reduce the load on non-router machines since they generally do not listen to the RIP multicast address and so will not receive the RIP packets. However, if one router uses multicasting, then all routers on your network must use multicasting, also. By default, RIP direction is set to Both and the Version set to RIP-1 .
Apply	Click Apply to save your changes back to the ZyXEL Device.
Cancel	Click Cancel to begin configuring this screen afresh.

CHAPTER 7

Wireless LAN

This chapter discusses how to configure the wireless network settings in your ZyXEL Device. See the appendices for more detailed information about wireless networks.

7.1 Wireless Network Overview

The following figure provides an example of a wireless network.

Figure 56 Example of a Wireless Network

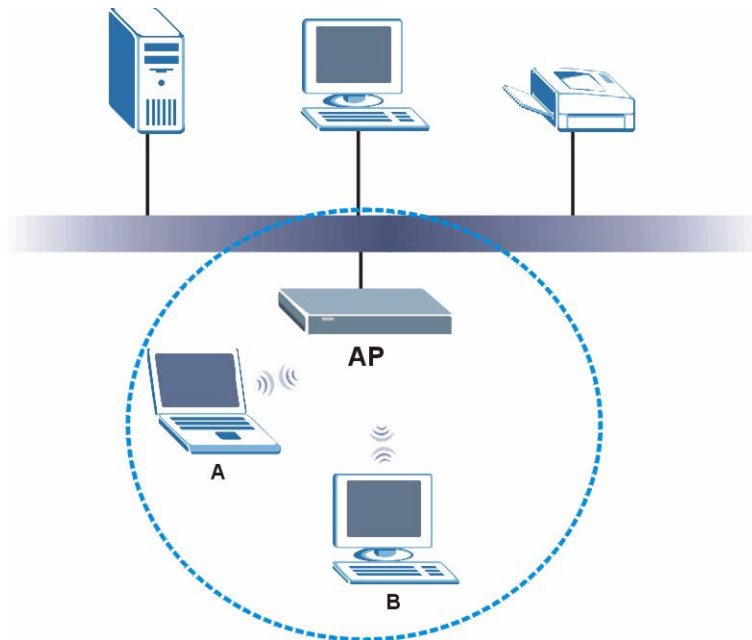

The wireless network is the part in the blue circle. In this wireless network, devices A and B are called wireless clients. The wireless clients use the access point (AP) to interact with other devices (such as the printer) or with the Internet. Your ZyXEL Device is the AP.

Every wireless network must follow these basic guidelines.

- Every wireless client in the same wireless network must use the same SSID.
The SSID is the name of the wireless network. It stands for Service Set IDentity.
- If two wireless networks overlap, they should use different channels.
Like radio stations or television channels, each wireless network uses a specific channel, or frequency, to send and receive information.

- Every wireless client in the same wireless network must use security compatible with the AP.

Security stops unauthorized devices from using the wireless network. It can also protect the information that is sent in the wireless network.

7.2 Wireless Security Overview

The following sections introduce different types of wireless security you can set up in the wireless network.

7.2.1 SSID

Normally, the AP acts like a beacon and regularly broadcasts the SSID in the area. You can hide the SSID instead, in which case the AP does not broadcast the SSID. In addition, you should change the default SSID to something that is difficult to guess.

This type of security is fairly weak, however, because there are ways for unauthorized devices to get the SSID. In addition, unauthorized devices can still see the information that is sent in the wireless network.

7.2.2 MAC Address Filter

Every wireless client has a unique identification number, called a MAC address.¹ A MAC address is usually written using twelve hexadecimal characters²; for example, 00A0C5000002 or 00:A0:C5:00:00:02. To get the MAC address for each wireless client, see the appropriate User's Guide or other documentation.

You can use the MAC address filter to tell the AP which wireless clients are allowed or not allowed to use the wireless network. If a wireless client is allowed to use the wireless network, it still has to have the correct settings (SSID, channel, and security). If a wireless client is not allowed to use the wireless network, it does not matter if it has the correct settings.

This type of security does not protect the information that is sent in the wireless network. Furthermore, there are ways for unauthorized devices to get the MAC address of an authorized wireless client. Then, they can use that MAC address to use the wireless network.

-
1. Some wireless devices, such as scanners, can detect wireless networks but cannot use wireless networks. These kinds of wireless devices might not have MAC addresses.
 2. Hexadecimal characters are 0, 1, 2, 3, 4, 5, 6, 7, 8, 9, A, B, C, D, E, and F.

7.2.3 User Authentication

Authentication is the process of verifying whether a wireless device is allowed to use the wireless network. You can make every user log in to the wireless network before they can use it. This is called user authentication. However, every wireless client in the wireless network has to support IEEE 802.1x to do this.

For wireless networks, there are two typical places to store the user names and passwords for each user.

- In the AP: this feature is called a local user database or a local database.
- In a RADIUS server: this is a server used in businesses more than in homes.

If your AP does not provide a local user database and if you do not have a RADIUS server, you cannot set up user names and passwords for your users.

Unauthorized devices can still see the information that is sent in the wireless network, even if they cannot use the wireless network. Furthermore, there are ways for unauthorized wireless users to get a valid user name and password. Then, they can use that user name and password to use the wireless network.

Local user databases also have an additional limitation that is explained in the next section.

7.2.4 Encryption

Wireless networks can use encryption to protect the information that is sent in the wireless network. Encryption is like a secret code. If you do not know the secret code, you cannot understand the message.

The types of encryption you can choose depend on the type of user authentication. (See [User Authentication on page 110](#) for information about this.)

Table 31 Types of Encryption for Each Type of Authentication

	No Authentication	RADIUS Server
Weakest  Strongest	No Security	WPA WPA2
	Static WEP	
	WPA-PSK	
	WPA2-PSK	

For example, if the wireless network has a RADIUS server, you can choose **WPA** or **WPA2**. If users do not log in to the wireless network, you can choose no encryption, **Static WEP**, **WPA-PSK**, or **WPA2-PSK**.

Usually, you should set up the strongest encryption that every wireless client in the wireless network supports. For example, suppose the AP does not have a local user database, and you do not have a RADIUS server. Therefore, there is no user authentication. Suppose the wireless network has two wireless clients. Device A only supports WEP, and device B supports WEP and WPA. Therefore, you should set up **Static WEP** in the wireless network.

Note: It is recommended that wireless networks use **WPA-PSK, WPA**, or stronger encryption. IEEE 802.1x and WEP encryption are better than none at all, but it is still possible for unauthorized devices to figure out the original information pretty quickly.

It is not possible to use **WPA-PSK, WPA** or stronger encryption with a local user database. In this case, it is better to set up stronger encryption with no authentication than to set up weaker encryption with the local user database.

When you select **WPA2** or **WPA2-PSK** in your ZyXEL Device, you can also select an option (**WPA compatible**) to support WPA as well. In this case, if some wireless clients support WPA and some support WPA2, you should set up **WPA2-PSK** or **WPA2** (depending on the type of wireless network login) and select the **WPA compatible** option in the ZyXEL Device.

Many types of encryption use a key to protect the information in the wireless network. The longer the key, the stronger the encryption. Every wireless client in the wireless network must have the same key.

7.2.5 One-Touch Intelligent Security Technology (OTIST)

With ZyXEL's OTIST, you set up the SSID and WPA-PSK on the ZyXEL Device. Then, the ZyXEL Device transfers them to the devices in the wireless networks. As a result, you do not have to set up the SSID and encryption on every device in the wireless network.

The devices in the wireless network have to support OTIST, and they have to be in range of the ZyXEL Device when you activate it. See [OTIST on page 120](#) for more details.

7.3 Wireless Performance Overview

The following sections introduce different ways to improve the performance of the wireless network.

7.3.1 Quality of Service (QoS)

You can turn on Wi-Fi MultiMedia (WMM) QoS to improve the performance of voice and video applications in the wireless network. QoS gives high priority to voice and video, which makes them run more smoothly. Similarly, it gives low priority to many large file downloads so that they do not reduce the quality of other applications.

7.4 General Wireless LAN Screen

Note: If you are configuring the ZyXEL Device from a computer connected to the wireless LAN and you change the ZyXEL Device's SSID or WEP settings, you will lose your wireless connection when you press **Apply** to confirm. You must then change the wireless settings of your computer to match the ZyXEL Device's new settings.

Click **Network > Wireless LAN** to open the **General** screen.

Figure 57 Wireless LAN: General

The following table describes the general wireless LAN labels in this screen.

Table 32 Wireless LAN: General

LABEL	DESCRIPTION
Active Wireless LAN	Click the check box to activate wireless LAN.
Network Name(SSID)	(Service Set Identity) The SSID identifies the Service Set with which a wireless client is associated. Wireless clients associating to the access point (AP) must have the same SSID. Enter a descriptive name (up to 32 printable 7-bit ASCII characters) for the wireless LAN. Note: If you are configuring the ZyXEL Device from a computer connected to the wireless LAN and you change the ZyXEL Device's SSID or WEP settings, you will lose your wireless connection when you press Apply to confirm. You must then change the wireless settings of your computer to match the ZyXEL Device's new settings.
Hide SSID	Select this check box to hide the SSID in the outgoing beacon frame so a station cannot obtain the SSID through scanning using a site survey tool.
Channel Selection	Set the operating frequency/channel depending on your particular region. Select a channel from the drop-down list box.

Table 32 Wireless LAN: General

LABEL	DESCRIPTION
Apply	Click Apply to save your changes back to the ZyXEL Device.
Cancel	Click Cancel to reload the previous configuration for this screen.
Advanced Setup	Click Advanced Setup to display the Wireless Advanced Setup screen and edit more details of your WLAN setup.

See the rest of this chapter for information on the other labels in this screen.

7.4.1 No Security

Select **No Security** to allow wireless clients to communicate with the access points without any data encryption.

Note: If you do not enable any wireless security on your ZyXEL Device, your network is accessible to any wireless networking device that is within range.

Figure 58 Wireless: No Security

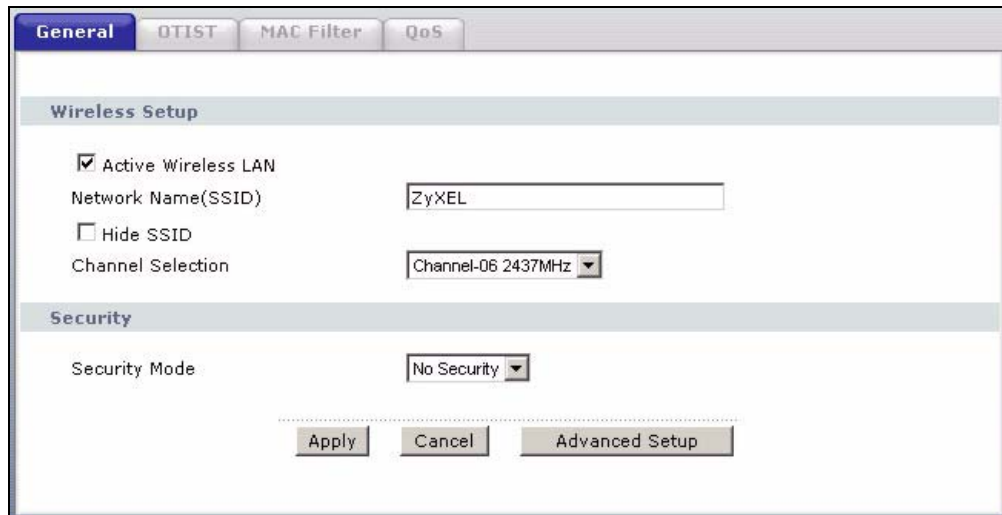

The following table describes the labels in this screen.

Table 33 Wireless No Security

LABEL	DESCRIPTION
Security Mode	Choose No Security from the drop-down list box.
Apply	Click Apply to save your changes back to the ZyXEL Device.
Cancel	Click Cancel to reload the previous configuration for this screen.
Advanced Setup	Click Advanced Setup to display the Wireless Advanced Setup screen and edit more details of your WLAN setup.

7.4.2 WEP Encryption

WEP encryption scrambles the data transmitted between the wireless clients and the access points to keep network communications private. It encrypts unicast and multicast communications in a network. Both the wireless clients and the access points must use the same WEP key.

Your ZyXEL Device allows you to configure up to four 64-bit, 128-bit or 256-bit WEP keys but only one key can be enabled at any one time.

In order to configure and enable WEP encryption; click **Network > Wireless LAN** to display the **General** screen. Select **Static WEP** from the **Security Mode** list.

Figure 59 Wireless: Static WEP Encryption

The screenshot shows the 'General' tab of the 'Wireless Setup' configuration page. Under 'Wireless Setup', 'Active Wireless LAN' is checked, 'Network Name (SSID)' is 'ZyXEL', 'Hide SSID' is unchecked, and 'Channel Selection' is 'Channel-06 2437MHz'. Under 'Security', 'Security Mode' is set to 'Static WEP', 'Passphrase' is 'fvoluyvclc', and 'WEP Key' is '292325f9e4'. A 'Generate' button is next to the passphrase field. A note explains WEP key lengths and character requirements. At the bottom are 'Apply', 'Cancel', and 'Advanced Setup' buttons.

The following table describes the wireless LAN security labels in this screen.

Table 34 Wireless: Static WEP Encryption

LABEL	DESCRIPTION
Security Mode	Choose Static WEP from the drop-down list box.
Passphrase	Enter a Passphrase (up to 32 printable characters) and clicking Generate . The ZyXEL Device automatically generates a WEP key.

Table 34 Wireless: Static WEP Encryption

LABEL	DESCRIPTION
WEP Key	The WEP keys are used to encrypt data. Both the ZyXEL Device and the wireless clients must use the same WEP key for data transmission. If you want to manually set the WEP key, enter any 5, 13 or 29 characters (ASCII string) or 10, 26 or 58 hexadecimal characters ("0-9", "A-F") for a 64-bit, 128-bit or 256-bit WEP key respectively.
Apply	Click Apply to save your changes back to the ZyXEL Device.
Cancel	Click Cancel to reload the previous configuration for this screen.
Advanced Setup	Click Advanced Setup to display the Wireless Advanced Setup screen and edit more details of your WLAN setup.

7.4.3 WPA-PSK/WPA2-PSK

In order to configure and enable WPA(2)-PSK authentication; click **Network > Wireless LAN** to display the **General** screen. Select **WPA-PSK** or **WPA2-PSK** from the **Security Mode** list.

Figure 60 Wireless: WPA-PSK/WPA2-PSK

The screenshot displays the 'Wireless Setup' configuration page. At the top, there are tabs for 'General', 'OTIST', 'MAC Filter', and 'QoS'. The 'General' tab is selected. The page is divided into two main sections: 'Wireless Setup' and 'Security'.

Wireless Setup Section:

- Active Wireless LAN
- Network Name(SSID):
- Hide SSID
- Channel Selection:

Security Section:

- Security Mode:
- WPA Compatible
- Pre-Shared Key:
- ReAuthentication Timer: (In Seconds)
- Idle Timeout: (In Seconds)
- Group Key Update Timer: (In Seconds)

At the bottom of the page, there are three buttons: 'Apply', 'Cancel', and 'Advanced Setup'.

The following table describes the wireless LAN security labels in this screen.

Table 35 Wireless: WPA-PSK/WPA2-PSK

LABEL	DESCRIPTION
Security Mode	Choose WPA-PSK or WPA2-PSK from the drop-down list box.
WPA Compatible	This check box is available only when you select WPA2-PSK or WPA2 in the Security Mode field. Select the check box to have both WPA2 and WPA wireless clients be able to communicate with the ZyXEL Device even when the ZyXEL Device is using WPA2-PSK or WPA2.
Pre-Shared Key	The encryption mechanisms used for WPA/WPA2 and WPA-PSK/WPA2-PSK are the same. The only difference between the two is that WPA-PSK/WPA2-PSK uses a simple common password, instead of user-specific credentials. Type a pre-shared key from 8 to 63 case-sensitive ASCII characters (including spaces and symbols).
ReAuthentication Timer (In Seconds)	Specify how often wireless clients have to resend usernames and passwords in order to stay connected. Enter a time interval between 10 and 9999 seconds. The default time interval is 1800 seconds (30 minutes). Note: If wireless client authentication is done using a RADIUS server, the reauthentication timer on the RADIUS server has priority.
Idle Timeout (In Seconds)	The ZyXEL Device automatically disconnects a wireless station from the wireless network after a period of inactivity. The wireless station needs to send the username and password again before it can use the wireless network again. Some wireless clients may prompt users for a username and password; other clients may use saved login credentials. In either case, there is usually a short delay while the wireless client logs in to the wireless network again. This value is usually smaller when the wireless network is keeping track of how much time each wireless station is connected to the wireless network (for example, using an authentication server). If the wireless network is not keeping track of this information, you can usually set this value higher to reduce the number of delays caused by logging in again.
Group Key Update Timer (In Seconds)	The Group Key Update Timer is the rate at which the AP (if using WPA-PSK/WPA2-PSK key management) or RADIUS server (if using WPA(2) key management) sends a new group key out to all clients. The re-keying process is the WPA(2) equivalent of automatically changing the WEP key for an AP and all stations in a WLAN on a periodic basis. Setting of the Group Key Update Timer is also supported in WPA-PSK/WPA2-PSK mode. The default is 1800 seconds (30 minutes).
Apply	Click Apply to save your changes back to the ZyXEL Device.
Cancel	Click Cancel to reload the previous configuration for this screen.
Advanced Setup	Click Advanced Setup to display the Wireless Advanced Setup screen and edit more details of your WLAN setup.

7.4.4 WPA/WPA2

In order to configure and enable WPA/WPA2; click the **Wireless LAN** link under **Network** to display the **General** screen. Select **WPA** or **WPA2** from the **Security Mode** list.

Figure 61 Wireless: WPA/WPA2

The screenshot shows the 'Wireless Setup' and 'Security' configuration pages. The 'General' tab is active. Under 'Wireless Setup', the 'Active Wireless LAN' checkbox is checked. The 'Network Name(SSID)' is 'ZyXEL', 'Hide SSID' is unchecked, and 'Channel Selection' is 'Channel-06 2437MHz'. Under 'Security', 'Security Mode' is 'WPA2', 'WPA Compatible' is unchecked, and the 'ReAuthentication Timer', 'Idle Timeout', and 'Group Key Update Timer' are all set to 1800 seconds. There are also fields for 'Authentication Server' (IP Address: 0.0.0.0, Port Number: 1812, Shared Secret) and 'Accounting Server (optional)' (IP Address: 0.0.0.0, Port Number: 1813, Shared Secret). At the bottom are 'Apply', 'Cancel', and 'Advanced Setup' buttons.

The following table describes the wireless LAN security labels in this screen.

Table 36 Wireless: WPA/WPA2

LABEL	DESCRIPTION
WPA Compatible	This check box is available only when you select WPA2-PSK or WPA2 in the Security Mode field. Select the check box to have both WPA2 and WPA wireless clients be able to communicate with the ZyXEL Device even when the ZyXEL Device is using WPA2-PSK or WPA2.
ReAuthentication Timer (In Seconds)	Specify how often wireless clients have to resend usernames and passwords in order to stay connected. Enter a time interval between 10 and 9999 seconds. The default time interval is 1800 seconds (30 minutes). Note: If wireless client authentication is done using a RADIUS server, the reauthentication timer on the RADIUS server has priority.

Table 36 Wireless: WPA/WPA2

LABEL	DESCRIPTION
Idle Timeout (In Seconds)	<p>The ZyXEL Device automatically disconnects a wireless station from the wireless network after a period of inactivity. The wireless station needs to send the username and password again before it can use the wireless network again. Some wireless clients may prompt users for a username and password; other clients may use saved login credentials. In either case, there is usually a short delay while the wireless client logs in to the wireless network again.</p> <p>This value is usually smaller when the wireless network is keeping track of how much time each wireless station is connected to the wireless network (for example, using an authentication server). If the wireless network is not keeping track of this information, you can usually set this value higher to reduce the number of delays caused by logging in again.</p>
Group Key Update Timer (In Seconds)	<p>The Group Key Update Timer is the rate at which the AP (if using WPA-PSK/WPA2-PSK key management) or RADIUS server (if using WPA(2) key management) sends a new group key out to all clients. The re-keying process is the WPA(2) equivalent of automatically changing the WEP key for an AP and all stations in a WLAN on a periodic basis. Setting of the Group Key Update Timer is also supported in WPA-PSK/WPA2-PSK mode. The default is 1800 seconds (30 minutes).</p>
Authentication Server	
IP Address	Enter the IP address of the external authentication server in dotted decimal notation.
Port Number	<p>Enter the port number of the external authentication server. The default port number is 1812.</p> <p>You need not change this value unless your network administrator instructs you to do so with additional information.</p>
Shared Secret	<p>Enter a password (up to 31 alphanumeric characters) as the key to be shared between the external authentication server and the ZyXEL Device.</p> <p>The key must be the same on the external authentication server and your ZyXEL Device. The key is not sent over the network.</p>
Accounting Server (optional)	
Active	Select Yes from the drop down list box to enable user accounting through an external authentication server.
IP Address	Enter the IP address of the external accounting server in dotted decimal notation.
Port Number	<p>Enter the port number of the external accounting server. The default port number is 1813.</p> <p>You need not change this value unless your network administrator instructs you to do so with additional information.</p>
Shared Secret	<p>Enter a password (up to 31 alphanumeric characters) as the key to be shared between the external accounting server and the ZyXEL Device.</p> <p>The key must be the same on the external accounting server and your ZyXEL Device. The key is not sent over the network.</p>
Apply	Click Apply to save your changes back to the ZyXEL Device.
Cancel	Click Cancel to reload the previous configuration for this screen.
Advanced Setup	Click Advanced Setup to display the Wireless Advanced Setup screen and edit more details of your WLAN setup.

7.4.5 Wireless LAN Advanced Setup

To configure advanced wireless settings, click the **Advanced Setup** button in the **General** screen. The screen appears as shown.

Figure 62 Advanced

The screenshot shows the 'Wireless Advanced Setup' configuration window. It contains the following settings:

- RTS/CTS Threshold: 2432 (0 ~ 2432, 4096 when G+ Enhanced)
- Fragmentation Threshold: 2432 (256 ~ 2432, 4096 when G+ Enhanced)
- Output Power: Maximum
- Preamble: Long
- 802.11 Mode: Mixed
- Enable 802.11g+ mode
- Max. Frame Burst: 650 (0 ~ 1800)

At the bottom, there are three buttons: Back, Apply, and Cancel.

The following table describes the labels in this screen.

Table 37 Wireless LAN: Advanced

LABEL	DESCRIPTION
Wireless Advanced Setup	
RTS/CTS Threshold	Enter a value between 0 and 2432. If you select the Enable 802.11g+ mode checkbox, this field is grayed out and the ZyXEL Device uses 4096 automatically.
Fragmentation Threshold	It is the maximum data fragment size that can be sent. Enter a value between 256 and 2432. If you select the Enable 802.11g+ mode checkbox, this field is grayed out and the ZyXEL Device uses 4096 automatically.
Output Power	Set the output power of the ZyXEL Device in this field. This control changes the strength of the ZyXEL Device's antenna gain or transmission power. Antenna gain is the increase in coverage. Higher antenna gain improves the range of the signal for better communications. If there is a high density of APs within an area, decrease the output power of the ZyXEL Device to reduce interference with other APs. The options are Maximum , Middle and Minimum .
Preamble	Select Long preamble if you are unsure what preamble mode the wireless adapters support, and to provide more reliable communications in busy wireless networks. Select Short preamble if you are sure the wireless adapters support it, and to provide more efficient communications. Select Dynamic to have the ZyXEL Device automatically use short preamble when wireless adapters support it, otherwise the ZyXEL Device uses long preamble.

Table 37 Wireless LAN: Advanced

LABEL	DESCRIPTION
802.11 Mode	Select 802.11b Only to allow only IEEE 802.11b compliant WLAN devices to associate with the ZyXEL Device. Select 802.11g Only to allow only IEEE 802.11g compliant WLAN devices to associate with the ZyXEL Device. Select Mixed to allow either IEEE802.11b or IEEE802.11g compliant WLAN devices to associate with the ZyXEL Device. The transmission rate of your ZyXEL Device might be reduced.
Enable 802.11g+ mode	Select the Enable 802.11g+ mode checkbox to allow any ZyXEL WLAN devices that support this feature to associate with the ZyXEL Device at higher transmission speeds. This permits the ZyXEL Device to transmit at a higher speed than the 802.11g Only mode.
Max. Frame Burst	Enable Maximum Frame Burst to help eliminate collisions in mixed-mode networks (networks with both IEEE 802.11g and IEEE 802.11b traffic) and enhance the performance of both pure IEEE 802.11g and mixed IEEE 802.11b/g networks. Maximum Frame Burst sets the maximum time, in micro-seconds, that the ZZyXEL Device transmits IEEE 802.11g wireless traffic only. Type the maximum frame burst between 0 and 1800 (650, 1000 or 1800 recommended). Enter 0 to disable this feature.
Back	Click Back to return to the previous screen.
Apply	Click Apply to save your changes back to the ZyXEL Device.
Cancel	Click Cancel to reload the previous configuration for this screen.

7.5 OTIST

In a wireless network, the wireless clients must have the same SSID and security settings as the access point (AP) or wireless router (we will refer to both as “AP” here) in order to associate with it. Traditionally this meant that you had to configure the settings on the AP and then manually configure the exact same settings on each wireless client.

OTIST (One-Touch Intelligent Security Technology) allows you to transfer your AP’s SSID and WPA-PSK security settings to wireless clients that support OTIST and are within transmission range. You can also choose to have OTIST generate a WPA-PSK key for you if you didn’t configure one manually.

Note: OTIST replaces the pre-configured wireless settings on the wireless clients.

7.5.1 Enabling OTIST

You must enable OTIST on both the AP and wireless client before you start transferring settings.

Note: The AP and wireless client(s) MUST use the same **Setup key**.

7.5.1.1 AP

You can enable OTIST using the **RESET** button or the web configurator.

7.5.1.1.1 Reset button

If you use the **RESET** button, the default (01234567) or previous saved (through the web configurator) **Setup key** is used to encrypt the settings that you want to transfer.

Hold in the **RESET** button for one to five seconds.

Note: If you hold in the **RESET** button too long, the device will reset to the factory defaults!

7.5.1.1.2 Web Configurator

Click the **Network > Wireless LAN > OTIST**. The following screen displays.

Figure 63 OTIST



The screenshot shows the OTIST configuration page in a web browser. At the top, there are four tabs: "General", "OTIST" (which is selected and highlighted in blue), "MAC Filter", and "QoS". Below the tabs, the page title is "OTIST". There is a "Setup Key" label followed by an empty text input field. Below the input field, there is a checkbox with the text "Yes! Please enhance the Wireless Security Level to WPA-PSK automatically if no WLAN security has been set. This will generate a random PSK key for your convenience." Below the checkbox, there is a "Start" button.

The following table describes the labels in this screen.

Table 38 OTIST

LABEL	DESCRIPTION
Setup Key	Type an OTIST Setup Key of exactly eight ASCII characters in length. The default OTIST setup key is "01234567". Note: If you change the OTIST setup key here, you must also make the same change on the wireless client(s).
Yes!	If you want OTIST to automatically generate a WPA-PSK, you must: <ul style="list-style-type: none"> • Change your security to any security other than WPA-PSK in the Wireless LAN > General screen. • Select the Yes! checkbox in the OTIST screen and click Start. • The wireless screen displays an auto generated WPA-PSK and is now in WPA-PSK security mode. The WPA-PSK security settings are assigned to the wireless client when you start OTIST. Note: If you already have a WPA-PSK configured in the Wireless LAN > General screen, and you run OTIST with Yes! selected, OTIST will use the existing WPA-PSK.
Start	Click Start to encrypt the wireless security data using the setup key and have the ZyXEL Device set the wireless client to use the same wireless settings as the ZyXEL Device. You must also activate and start OTIST on the wireless client all within three minutes.

7.5.1.2 Wireless Client

Start the ZyXEL utility and click the **Adapter** tab. Select the **OTIST** check box, enter the same **Setup Key** as your AP's and click **Save**.

Figure 64 Example Wireless Client OTIST Screen

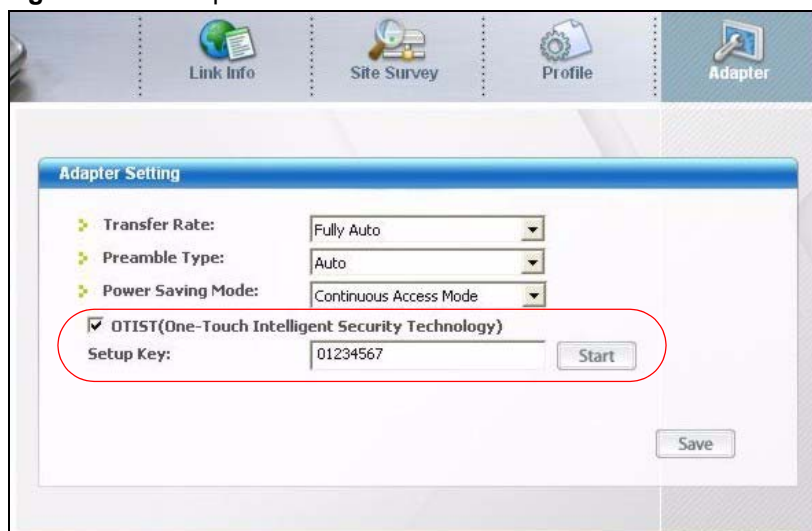

7.5.2 Starting OTIST

Note: You must click **Start** in the AP **OTIST** web configurator screen and in the wireless client(s) **Adapter** screen all within three minutes (at the time of writing). You can start OTIST in the wireless clients and AP in any order but they must all be within range and have OTIST enabled.

- 1 In the AP, a web configurator screen pops up showing you the security settings to transfer. You can use the key in this screen to set up WPA-PSK encryption manually for non-OTIST devices in the wireless network. After reviewing the settings, click **OK**.

Figure 65 Security Key

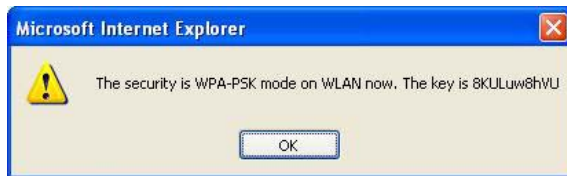

- 2 This screen appears while OTIST settings are being transferred. It closes when the transfer is complete.

Figure 66 OTIST in Progress (AP)



Figure 67 OTIST in Progress (Client)

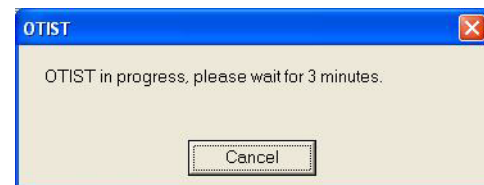

- In the wireless client, you see this screen if it can't find an OTIST-enabled AP (with the same **Setup key**). Click **OK** to go back to the ZyXEL utility main screen.

Figure 68 No AP with OTIST Found



- If there is more than one OTIST-enabled AP within range, you see a screen asking you to select one AP to get settings from.

7.5.3 Notes on OTIST

- 1 If you enabled OTIST in the wireless client, you see this screen each time you start the utility. Click **Yes** for it to search for an OTIST-enabled AP.

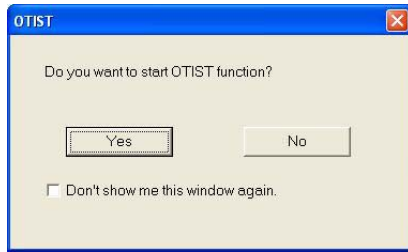
Figure 69 Start OTIST?

- 2** If an OTIST-enabled wireless client loses its wireless connection for more than ten seconds, it will search for an OTIST-enabled AP for up to one minute. (If you manually have the wireless client search for an OTIST-enabled AP, there is no timeout; click **Cancel** in the OTIST progress screen to stop the search.)
- 3** When the wireless client finds an OTIST-enabled AP, you must still click **Start** in the AP **OTIST** web configurator screen or hold in the **RESET** button (for one to five seconds) for the AP to transfer settings.
- 4** If you change the SSID or the keys on the AP after using OTIST, you need to run OTIST again or enter them manually in the wireless client(s).
- 5** If you configure OTIST to generate a WPA-PSK key, this key changes each time you run OTIST. Therefore, if a new wireless client joins your wireless network, you need to run OTIST on the AP and ALL wireless clients again.

7.6 MAC Filter

The MAC filter screen allows you to configure the ZyXEL Device to give exclusive access to up to 32 devices (**Allow**) or exclude up to 32 devices from accessing the ZyXEL Device (**Deny**). Every Ethernet device has a unique MAC (Media Access Control) address. The MAC address is assigned at the factory and consists of six pairs of hexadecimal characters, for example, 00:A0:C5:00:00:02. You need to know the MAC address of the devices to configure this screen.

To change your ZyXEL Device's MAC filter settings, click **Network > Wireless LAN > MAC Filter**. The screen appears as shown.

Figure 70 MAC Address Filter

The following table describes the labels in this menu.

Table 39 MAC Address Filter

LABEL	DESCRIPTION
Active MAC Filter	Select the check box to enable MAC address filtering.
Filter Action	Define the filter action for the list of MAC addresses in the MAC Address table. Select Deny to block access to the ZyXEL Device, MAC addresses not listed will be allowed to access the ZyXEL Device Select Allow to permit access to the ZyXEL Device, MAC addresses not listed will be denied access to the ZyXEL Device.
Set	This is the index number of the MAC address.
MAC Address	Enter the MAC addresses of the wireless client that are allowed or denied access to the ZyXEL Device in these address fields. Enter the MAC addresses in a valid MAC address format, that is, six hexadecimal character pairs, for example, 12:34:56:78:9a:bc.
Apply	Click Apply to save your changes back to the ZyXEL Device.
Cancel	Click Cancel to reload the previous configuration for this screen.

7.7 WMM QoS

WMM (Wi-Fi MultiMedia) QoS (Quality of Service) allows you to prioritize wireless traffic according to the delivery requirements of individual services.

WMM is a part of the IEEE 802.11e QoS enhancement to certified Wi-Fi wireless networks.

7.7.1 WMM QoS Example

When WMM QoS is not enabled, all traffic streams are given the same access throughput to the wireless network. If the introduction of another traffic stream creates a data transmission demand that exceeds the current network capacity, then the new traffic stream reduces the throughput of the other traffic streams.

When WMM QoS is enabled, the streams are prioritized according to the needs of the application. You can assign different priorities to different applications. This prevents reductions in data transmission for applications that are sensitive.

7.7.2 WMM QoS Priorities

The following table describes the priorities that you can apply to traffic that the ZyXEL Device sends to the wireless network.

Table 40 WMM QoS Priorities

PRIORITY LEVELS:	
Highest	Typically used for voice traffic or video that is especially sensitive to jitter (variations in delay). Use the highest priority to reduce latency for improved voice quality.
High	Typically used for video traffic which has some tolerance for jitter but needs to be prioritized over other data traffic.
Mid	Typically used for traffic from applications or devices that lack QoS capabilities. Use mid priority for traffic that is less sensitive to latency, but is affected by long delays, such as Internet surfing.
Low	This is typically used for non-critical "background" traffic such as bulk transfers and print jobs that are allowed but that should not affect other applications and users. Use low priority for applications that do not have strict latency and throughput requirements.

7.7.3 Services

The commonly used services and port numbers are shown in the following table. Please refer to RFC 1700 for further information about port numbers. Next to the name of the service, two fields appear in brackets. The first field indicates the IP protocol type (TCP, UDP, or ICMP). The second field indicates the IP port number that defines the service. (Note that there may be more than one IP protocol type. For example, look at the DNS service. (UDP/TCP:53) means UDP port 53 and TCP port 53.

Table 41 Commonly Used Services

SERVICE	DESCRIPTION
AIM/New-ICQ(TCP:5190)	AOL's Internet Messenger service, used as a listening port by ICQ.
AUTH(TCP:113)	Authentication protocol used by some servers.
BGP(TCP:179)	Border Gateway Protocol.
BOOTP_CLIENT(UDP:68)	DHCP Client.
BOOTP_SERVER(UDP:67)	DHCP Server.
CU-SEEME(TCP/UDP:7648, 24032)	A popular videoconferencing solution from White Pines Software.
DNS(UDP/TCP:53)	Domain Name Server, a service that matches web names (e.g. www.zyxel.com) to IP numbers.
FINGER(TCP:79)	Finger is a UNIX or Internet related command that can be used to find out if a user is logged on.
FTP(TCP:20.21)	File Transfer Program, a program to enable fast transfer of files, including large files that may not be possible by e-mail.
H.323(TCP:1720)	NetMeeting uses this protocol.
HTTP(TCP:80)	Hyper Text Transfer Protocol - a client/server protocol for the world wide web.
HTTPS(TCP:443)	HTTPS is a secured http session often used in e-commerce.
ICQ(UDP:4000)	This is a popular Internet chat program.
IKE(UDP:500)	The Internet Key Exchange algorithm is used for key distribution and management.
IPSEC_TUNNEL(AH:0)	The IPSEC AH (Authentication Header) tunneling protocol uses this service.
IPSEC_TUNNEL(ESP:0)	The IPSEC ESP (Encapsulation Security Protocol) tunneling protocol uses this service.
IRC(TCP/UDP:6667)	This is another popular Internet chat program.
MSN Messenger(TCP:1863)	Microsoft Networks' messenger service uses this protocol.
MULTICAST(IGMP:0)	Internet Group Multicast Protocol is used when sending packets to a specific group of hosts.
NEW-ICQ(TCP:5190)	An Internet chat program.
NEWS(TCP:144)	A protocol for news groups.
NFS(UDP:2049)	Network File System - NFS is a client/server distributed file service that provides transparent file sharing for network environments.
NNTP(TCP:119)	Network News Transport Protocol is the delivery mechanism for the USENET newsgroup service.

Table 41 Commonly Used Services

SERVICE	DESCRIPTION
PING(ICMP:0)	Packet Internet Groper is a protocol that sends out ICMP echo requests to test whether or not a remote host is reachable.
POP3(TCP:110)	Post Office Protocol version 3 lets a client computer get e-mail from a POP3 server through a temporary connection (TCP/IP or other).
PPTP(TCP:1723)	Point-to-Point Tunneling Protocol enables secure transfer of data over public networks. This is the control channel.
PPTP_TUNNEL(GRE:0)	Point-to-Point Tunneling Protocol enables secure transfer of data over public networks. This is the data channel.
RCMD(TCP:512)	Remote Command Service.
REAL_AUDIO(TCP:7070)	A streaming audio service that enables real time sound over the web.
REXEC(TCP:514)	Remote Execution Daemon.
RLOGIN(TCP:513)	Remote Login.
RTELNET(TCP:107)	Remote Telnet.
RTSP(TCP/UDP:554)	The Real Time Streaming (media control) Protocol (RTSP) is a remote control for multimedia on the Internet.
SFTP(TCP:115)	Simple File Transfer Protocol.
SMTP(TCP:25)	Simple Mail Transfer Protocol is the message-exchange standard for the Internet. SMTP enables you to move messages from one e-mail server to another.
SNMP(TCP/UDP:161)	Simple Network Management Program.
SNMP-TRAPS(TCP/UDP:162)	Traps for use with the SNMP (RFC:1215).
SQL-NET(TCP:1521)	Structured Query Language is an interface to access data on many different types of database systems, including mainframes, midrange systems, UNIX systems and network servers.
SSH(TCP/UDP:22)	Secure Shell Remote Login Program.
STRM WORKS(UDP:1558)	Stream Works Protocol.
SYSLOG(UDP:514)	Syslog allows you to send system logs to a UNIX server.
TACACS(UDP:49)	Login Host Protocol used for (Terminal Access Controller Access Control System).
TELNET(TCP:23)	Telnet is the login and terminal emulation protocol common on the Internet and in UNIX environments. It operates over TCP/IP networks. Its primary function is to allow users to log into remote host systems.
TFTP(UDP:69)	Trivial File Transfer Protocol is an Internet file transfer protocol similar to FTP, but uses the UDP (User Datagram Protocol) rather than TCP (Transmission Control Protocol).
VDOLIVE(TCP:7000)	Another videoconferencing solution.

7.8 QoS Screen

The QoS screen by default allows you to automatically give a service a priority level according to the ToS value in the IP header of the packets it sends.

7.8.1 ToS (Type of Service) and WMM QoS

ToS defines the DS (Differentiated Service) field in the IP packet header. The ToS value of outgoing packets is between 0 and 255. 0 is the lowest priority.

WMM QoS checks the ToS in the header of transmitted data packets. It gives the application a priority according to this number. If the ToS is not specified, then transmitted data is treated as normal or best-effort traffic.

Click **Network > Wireless LAN > QoS**. The following screen displays.

Figure 71 Wireless LAN: QoS

#	Name:	Service	Dest Port	Priority	Modify
1	-	-	0	-	
2	-	-	0	-	
3	-	-	0	-	
4	-	-	0	-	
5	-	-	0	-	
6	-	-	0	-	
7	-	-	0	-	
8	-	-	0	-	
9	-	-	0	-	
10	-	-	0	-	

The following table describes the fields in this screen.

Table 42 Wireless LAN: QoS

LABEL	DESCRIPTION
QoS	
Enable WMM QoS	Select the check box to enable WMM QoS on the ZyXEL Device.
WMM QoS Policy	Select Default to have the ZyXEL Device automatically give a service a priority level according to the ToS value in the IP header of packets it sends. Select Application Priority from the drop-down list box to display a table of application names, services, ports and priorities to which you want to apply WMM QoS.
#	This is the number of an individual application entry.
Name	This field displays a description given to an application entry.

Table 42 Wireless LAN: QoS

LABEL	DESCRIPTION
Service	This field displays either FTP , WWW , E-mail or a User Defined service to which you want to apply WMM QoS.
Dest Port	This field displays the destination port number to which the application sends traffic.
Priority	This field displays the WMM QoS priority for traffic bandwidth.
Modify	Click the Edit icon to open the Application Priority Configuration screen. Modify an existing application entry or create a application entry in the Application Priority Configuration screen. Click the Remove icon to delete an application entry.
Apply	Click Apply to save your changes back to the ZyXEL Device.
Cancel	Click Cancel to reload the previous configuration for this screen.

7.8.2 Application Priority Configuration

To edit a WMM QoS application entry, click the edit icon under **Modify**. The following screen displays.

Figure 72 Application Priority Configuration

The following table describes the fields in this screen.

Table 43 Application Priority Configuration

LABEL	DESCRIPTION
Application Priority Configuration	
Name	Type a description of the application priority.

Table 43 Application Priority Configuration

LABEL	DESCRIPTION
Service	<p>The following is a description of the applications you can prioritize with WMM QoS. Select a service from the drop-down list box.</p> <ul style="list-style-type: none"> • FTP File Transfer Program enables fast transfer of files, including large files that may not be possible by e-mail. FTP uses port number 21. • E-Mail Electronic mail consists of messages sent through a computer network to specific groups or individuals. Here are some default ports for e-mail: POP3 - port 110 IMAP - port 143 SMTP - port 25 HTTP - port 80 • WWW The World Wide Web is an Internet system to distribute graphical, hyper-linked information, based on Hyper Text Transfer Protocol (HTTP) - a client/server protocol for the World Wide Web. The Web is not synonymous with the Internet; rather, it is just one service on the Internet. Other services on the Internet include Internet Relay Chat and Newsgroups. The Web is accessed through use of a browser. • User-Defined User-defined services are user specific services configured using known ports and applications.
Dest Port	This displays the port the selected service uses. Type a port number in the field provided if you want to use a different port to the default port. See table Table 41 on page 127 for information on port numbers.
Priority	Select a priority from the drop-down list box.
Apply	Click Apply to save your changes back to the ZyXEL Device.
Cancel	Click Cancel to return to the previous screen without saving your changes.

CHAPTER 8

Network Address Translation (NAT) Screens

This chapter discusses how to configure NAT on the ZyXEL Device.

8.1 NAT Overview

NAT (Network Address Translation - NAT, RFC 1631) is the translation of the IP address of a host in a packet, for example, the source address of an outgoing packet, used within one network to a different IP address known within another network.

8.1.1 NAT Definitions

Inside/outside denotes where a host is located relative to the ZyXEL Device, for example, the computers of your subscribers are the inside hosts, while the web servers on the Internet are the outside hosts.

Global/local denotes the IP address of a host in a packet as the packet traverses a router, for example, the local address refers to the IP address of a host when the packet is in the local network, while the global address refers to the IP address of the host when the same packet is traveling in the WAN side.

Note that inside/outside refers to the location of a host, while global/local refers to the IP address of a host used in a packet. Thus, an inside local address (ILA) is the IP address of an inside host in a packet when the packet is still in the local network, while an inside global address (IGA) is the IP address of the same inside host when the packet is on the WAN side. The following table summarizes this information.

Table 44 NAT Definitions

ITEM	DESCRIPTION
Inside	This refers to the host on the LAN.
Outside	This refers to the host on the WAN.
Local	This refers to the packet address (source or destination) as the packet travels on the LAN.
Global	This refers to the packet address (source or destination) as the packet travels on the WAN.

NAT never changes the IP address (either local or global) of an outside host.

8.1.2 What NAT Does

In the simplest form, NAT changes the source IP address in a packet received from a subscriber (the inside local address) to another (the inside global address) before forwarding the packet to the WAN side. When the response comes back, NAT translates the destination address (the inside global address) back to the inside local address before forwarding it to the original inside host. Note that the IP address (either local or global) of an outside host is never changed.

The global IP addresses for the inside hosts can be either static or dynamically assigned by the ISP. In addition, you can designate servers, for example, a web server and a telnet server, on your local network and make them accessible to the outside world. If you do not define any servers (for Many-to-One and Many-to-Many Overload mapping – see [Table 45 on page 135](#)), NAT offers the additional benefit of firewall protection. With no servers defined, your ZyXEL Device filters out all incoming inquiries, thus preventing intruders from probing your network. For more information on IP address translation, refer to *RFC 1631, The IP Network Address Translator (NAT)*.

8.1.3 How NAT Works

Each packet has two addresses – a source address and a destination address. For outgoing packets, the ILA (Inside Local Address) is the source address on the LAN, and the IGA (Inside Global Address) is the source address on the WAN. For incoming packets, the ILA is the destination address on the LAN, and the IGA is the destination address on the WAN. NAT maps private (local) IP addresses to globally unique ones required for communication with hosts on other networks. It replaces the original IP source address (and TCP or UDP source port numbers for Many-to-One and Many-to-Many Overload NAT mapping) in each packet and then forwards it to the Internet. The ZyXEL Device keeps track of the original addresses and port numbers so incoming reply packets can have their original values restored. The following figure illustrates this.

Figure 73 How NAT Works

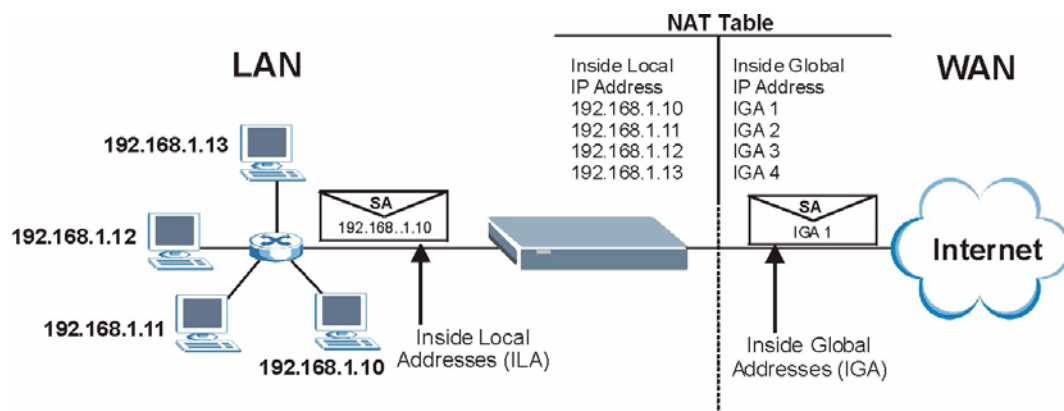

8.1.4 NAT Application

The following figure illustrates a possible NAT application, where three inside LANs (logical LANs using IP Aliases) behind the ZyXEL Device can communicate with three distinct WAN networks. More examples follow at the end of this chapter.

Figure 74 NAT Application With IP Alias

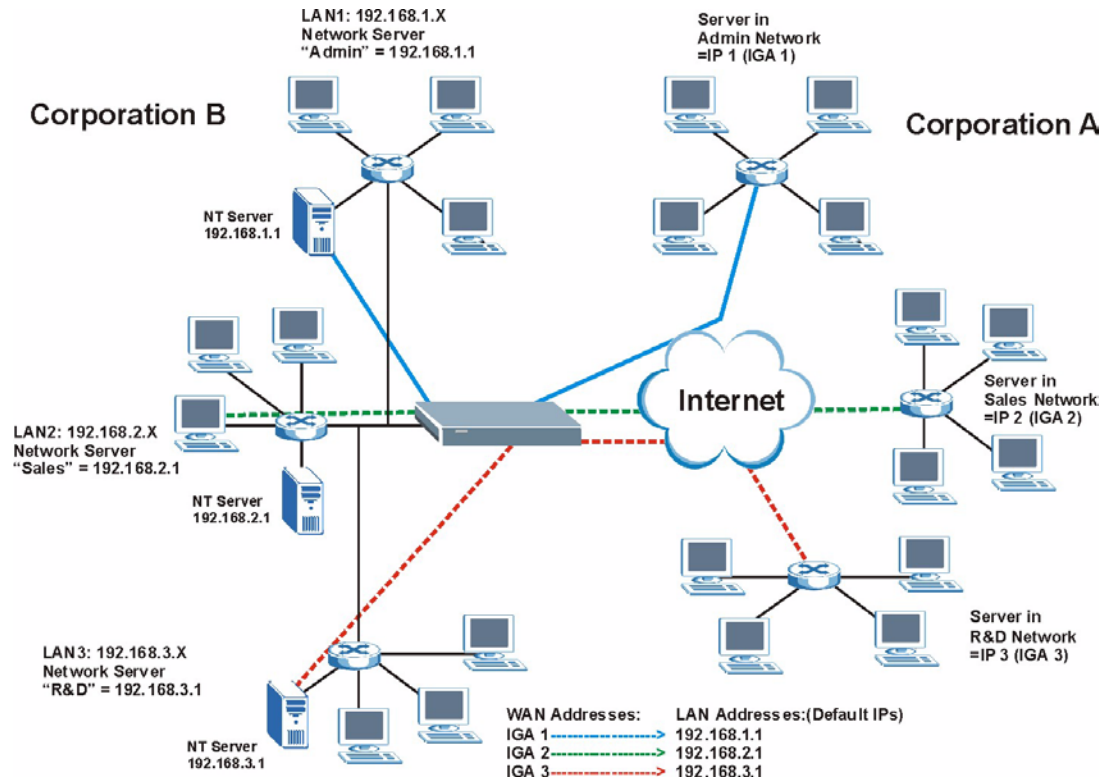

8.1.5 NAT Mapping Types

NAT supports five types of IP/port mapping. They are:

- **One to One:** In One-to-One mode, the ZyXEL Device maps one local IP address to one global IP address.
- **Many to One:** In Many-to-One mode, the ZyXEL Device maps multiple local IP addresses to one global IP address. This is equivalent to SUA (for instance, PAT, port address translation), ZyXEL's Single User Account feature that previous ZyXEL routers supported (the **SUA Only** option in today's routers).
- **Many to Many Overload:** In Many-to-Many Overload mode, the ZyXEL Device maps the multiple local IP addresses to shared global IP addresses.
- **Many-to-Many No Overload:** In Many-to-Many No Overload mode, the ZyXEL Device maps each local IP address to a unique global IP address.
- **Server:** This type allows you to specify inside servers of different services behind the NAT to be accessible to the outside world.

Port numbers do NOT change for **One-to-One** and **Many-to-Many No Overload** NAT mapping types.

The following table summarizes these types.

Table 45 NAT Mapping Types

TYPE	IP MAPPING
One-to-One	ILA1 ↔ IGA1
Many-to-One (SUA/PAT)	ILA1 ↔ IGA1 ILA2 ↔ IGA1 ...
Many-to-Many Overload	ILA1 ↔ IGA1 ILA2 ↔ IGA2 ILA3 ↔ IGA1 ILA4 ↔ IGA2 ...
Many-to-Many No Overload	ILA1 ↔ IGA1 ILA2 ↔ IGA2 ILA3 ↔ IGA3 ...
Server	Server 1 IP ↔ IGA1 Server 2 IP ↔ IGA1 Server 3 IP ↔ IGA1

8.2 SUA (Single User Account) Versus NAT

SUA (Single User Account) is a ZyNOS implementation of a subset of NAT that supports two types of mapping, **Many-to-One** and **Server**. The ZyXEL Device also supports **Full Feature** NAT to map multiple global IP addresses to multiple private LAN IP addresses of clients or servers using mapping types as outlined in [Table 45 on page 135](#).

- Choose **SUA Only** if you have just one public WAN IP address for your ZyXEL Device.
- Choose **Full Feature** if you have multiple public WAN IP addresses for your ZyXEL Device.

8.3 NAT General Setup

You must create a firewall rule in addition to setting up SUA/NAT, to allow traffic from the WAN to be forwarded through the ZyXEL Device. Click **Network > NAT** to open the following screen. Not all fields are available on all models.

Figure 75 NAT General (P-660H-D)

The following table describes the labels in this screen.

Table 46 NAT General

LABEL	DESCRIPTION
Active Network Address Translation (NAT)	Select this check box to enable NAT.
SUA Only	Select this radio button if you have just one public WAN IP address for your ZyXEL Device.
Full Feature	Select this radio button if you have multiple public WAN IP addresses for your ZyXEL Device.
Max NAT/ Firewall Session Per User	Enter the highest number of concurrent NAT and/or firewall sessions that the ZyXEL Device will permit a user to have.
Apply	Click Apply to save your changes back to the ZyXEL Device.
Cancel	Click Cancel to reload the previous configuration for this screen.

8.4 Port Forwarding

A port forwarding set is a list of inside (behind NAT on the LAN) servers, for example, web or FTP, that you can make visible to the outside world even though NAT makes your whole inside network appear as a single computer to the outside world.

You may enter a single port number or a range of port numbers to be forwarded, and the local IP address of the desired server. The port number identifies a service; for example, web service is on port 80 and FTP on port 21. In some cases, such as for unknown services or where one server can support more than one service (for example both FTP and web service), it might be better to specify a range of port numbers. You can allocate a server IP address that corresponds to a port or a range of ports.

Many residential broadband ISP accounts do not allow you to run any server processes (such as a Web or FTP server) from your location. Your ISP may periodically check for servers and may suspend your account if it discovers any active services at your location. If you are unsure, refer to your ISP.

8.4.1 Default Server IP Address

In addition to the servers for specified services, NAT supports a default server IP address. A default server receives packets from ports that are not specified in this screen.

Note: If you do not assign a **Default Server** IP address, the ZyXEL Device discards all packets received for ports that are not specified here or in the remote management setup.

8.4.2 Port Forwarding: Services and Port Numbers

Use the **Port Forwarding** screen to forward incoming service requests to the server(s) on your local network.

The most often used port numbers are shown in the following table. Please refer to RFC 1700 for further information about port numbers.

Table 47 Services and Port Numbers

SERVICES	PORT NUMBER
ECHO	7
FTP (File Transfer Protocol)	21
SMTP (Simple Mail Transfer Protocol)	25
DNS (Domain Name System)	53
Finger	79
HTTP (Hyper Text Transfer protocol or WWW, Web)	80
POP3 (Post Office Protocol)	110
NNTP (Network News Transport Protocol)	119
SNMP (Simple Network Management Protocol)	161
SNMP trap	162
PPTP (Point-to-Point Tunneling Protocol)	1723

8.4.3 Configuring Servers Behind Port Forwarding (Example)

Let's say you want to assign ports 21-25 to one FTP, Telnet and SMTP server (**A** in the example), port 80 to another (**B** in the example) and assign a default server IP address of 192.168.1.35 to a third (**C** in the example). You assign the LAN IP addresses and the ISP assigns the WAN IP address. The NAT network appears as a single host on the Internet.

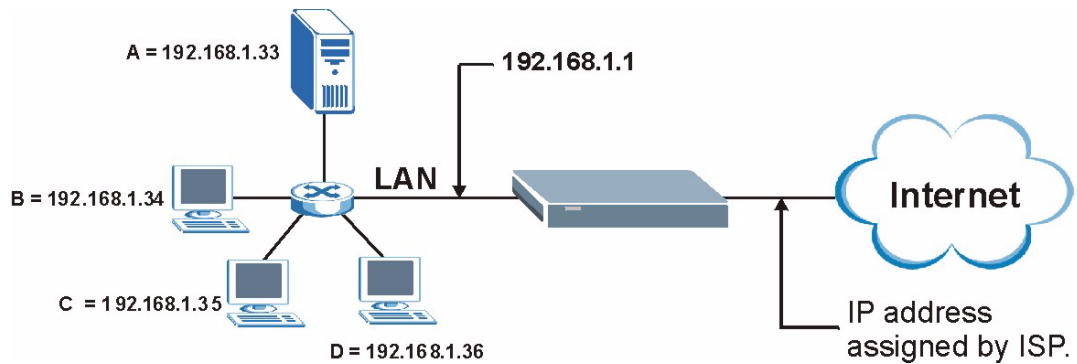
Figure 76 Multiple Servers Behind NAT Example

8.5 Configuring Port Forwarding

Note: The **Port Forwarding** screen is available only when you select **SUA Only** in the **NAT > General** screen.

If you do not assign a **Default Server** IP address, the ZyXEL Device discards all packets received for ports that are not specified here or in the remote management setup.

Click **Network > NAT > Port Forwarding** to open the following screen.

See [Table 47 on page 137](#) for port numbers commonly used for particular services.

Figure 77 NAT Port Forwarding

The screenshot shows the 'Port Forwarding' configuration screen. The 'Default Server Setup' section has a 'Default Server' field set to 0.0.0.0. The 'Port Forwarding' section has a 'Service Name' dropdown set to 'WWW' and a 'Server IP Address' field set to 0.0.0.0, with an 'Add' button to the right. Below this is a table with the following data:

#	Active	Service Name	Start Port	End Port	Server IP Address	Modify
1	<input checked="" type="checkbox"/>	WWW	80	80	172.23.15.23	

At the bottom of the screen are 'Apply' and 'Cancel' buttons.

The following table describes the fields in this screen.

Table 48 NAT Port Forwarding

LABEL	DESCRIPTION
Default Server Setup	
Default Server	In addition to the servers for specified services, NAT supports a default server. A default server receives packets from ports that are not specified in this screen. If you do not assign a Default Server IP address, the ZyXEL Device discards all packets received for ports that are not specified here or in the remote management setup.
Port Forwarding	
Service Name	Select a service from the drop-down list box.
Server IP Address	Enter the IP address of the server for the specified service.
Add	Click this button to add a rule to the table below.
#	This is the rule index number (read-only).
Active	Click this check box to enable the rule.
Service Name	This is a service's name.
Start Port	This is the first port number that identifies a service.
End Port	This is the last port number that identifies a service.
Server IP Address	This is the server's IP address.
Modify	Click the edit icon to go to the screen where you can edit the port forwarding rule. Click the delete icon to delete an existing port forwarding rule. Note that subsequent rules move up by one when you take this action.
Apply	Click Apply to save your changes back to the ZyXEL Device.
Cancel	Click Cancel to return to the previous configuration.

8.5.1 Port Forwarding Rule Edit

To edit a port forwarding rule, click the rule's edit icon in the **Port Forwarding** screen to display the screen shown next.

Figure 78 Port Forwarding Rule Setup

The screenshot shows a web-based configuration window titled "Rule Setup". It contains the following elements:

- A checked checkbox labeled "Active".
- A text input field for "Service Name" containing the text "WWW".
- A numeric input field for "Start Port" containing the value "80".
- A numeric input field for "End Port" containing the value "80".
- A text input field for "Server IP Address" containing the value "10.10.1.2".
- At the bottom of the form, there are three buttons: "Back", "Apply", and "Cancel".

The following table describes the fields in this screen.

Table 49 Port Forwarding Rule Setup

LABEL	DESCRIPTION
Active	Click this check box to enable the rule.
Service Name	Enter a name to identify this port-forwarding rule.
Start Port	Enter a port number in this field. To forward only one port, enter the port number again in the End Port field. To forward a series of ports, enter the start port number here and the end port number in the End Port field.
End Port	Enter a port number in this field. To forward only one port, enter the port number again in the Start Port field above and then enter it again in this field. To forward a series of ports, enter the last port number in a series that begins with the port number in the Start Port field above.
Server IP Address	Enter the inside IP address of the server here.
Back	Click Back to return to the previous screen.
Apply	Click Apply to save your changes back to the ZyXEL Device.
Cancel	Click Cancel to begin configuring this screen afresh.

8.6 Address Mapping

Note: The **Address Mapping** screen is available only when you select **Full Feature** in the **NAT > General** screen.

Ordering your rules is important because the ZyXEL Device applies the rules in the order that you specify. When a rule matches the current packet, the ZyXEL Device takes the corresponding action and the remaining rules are ignored. If there are any empty rules before your new configured rule, your configured rule will be pushed up by that number of empty rules. For example, if you have already configured rules 1 to 6 in your current set and now you configure rule number 9. In the set summary screen, the new rule will be rule 7, not 9. Now if you delete rule 4, rules 5 to 7 will be pushed up by 1 rule, so old rules 5, 6 and 7 become new rules 4, 5 and 6.

To change your ZyXEL Device's address mapping settings, click **Network > NAT > Address Mapping** to open the following screen.

Figure 79 Address Mapping Rules

#	Local Start IP	Local End IP	Global Start IP	Global End IP	Type	Modify
1	-	-	-	-	-	
2	-	-	-	-	-	
3	-	-	-	-	-	
4	-	-	-	-	-	
5	-	-	-	-	-	
6	-	-	-	-	-	
7	-	-	-	-	-	
8	-	-	-	-	-	
9	-	-	-	-	-	
10	-	-	-	-	-	

The following table describes the fields in this screen.

Table 50 Address Mapping Rules

LABEL	DESCRIPTION
#	This is the rule index number.
Local Start IP	This is the starting Inside Local IP Address (ILA). Local IP addresses are N/A for Server port mapping.
Local End IP	This is the end Inside Local IP Address (ILA). If the rule is for all local IP addresses, then this field displays 0.0.0.0 as the Local Start IP address and 255.255.255.255 as the Local End IP address. This field is N/A for One-to-one and Server mapping types.
Global Start IP	This is the starting Inside Global IP Address (IGA). Enter 0.0.0.0 here if you have a dynamic IP address from your ISP. You can only do this for Many-to-One and Server mapping types.
Global End IP	This is the ending Inside Global IP Address (IGA). This field is N/A for One-to-one , Many-to-One and Server mapping types.
Type	<p>1-1: One-to-one mode maps one local IP address to one global IP address. Note that port numbers do not change for the One-to-one NAT mapping type.</p> <p>M-1: Many-to-One mode maps multiple local IP addresses to one global IP address. This is equivalent to SUA (i.e., PAT, port address translation), ZyXEL's Single User Account feature that previous ZyXEL routers supported only.</p> <p>M-M Ov (Overload): Many-to-Many Overload mode maps multiple local IP addresses to shared global IP addresses.</p> <p>MM No (No Overload): Many-to-Many No Overload mode maps each local IP address to unique global IP addresses.</p> <p>Server: This type allows you to specify inside servers of different services behind the NAT to be accessible to the outside world.</p>
Modify	Click the edit icon to go to the screen where you can edit the address mapping rule. Click the delete icon to delete an existing address mapping rule. Note that subsequent address mapping rules move up by one when you take this action.

8.6.1 Address Mapping Rule Edit

To edit an address mapping rule, click the rule's edit icon in the **Address Mapping** screen to display the screen shown next.

Figure 80 Edit Address Mapping Rule

The screenshot shows a web-based configuration interface titled "Edit Address Mapping Rule 1". It contains several input fields and a dropdown menu. The "Type" field is a dropdown menu currently set to "One-to-One". The "Local Start IP" field contains "0.0.0.0", and the "Local End IP" field contains "N/A". The "Global Start IP" field contains "0.0.0.0", and the "Global End IP" field contains "N/A". The "Server Mapping Set" field is a dropdown menu currently set to "N/A", with a blue link "Edit Details" next to it. At the bottom of the form, there are three buttons: "Back", "Apply", and "Cancel".

The following table describes the fields in this screen.

Table 51 Edit Address Mapping Rule

LABEL	DESCRIPTION
Type	Choose the port mapping type from one of the following. <ul style="list-style-type: none"> • One-to-One: One-to-One mode maps one local IP address to one global IP address. Note that port numbers do not change for One-to-one NAT mapping type. • Many-to-One: Many-to-One mode maps multiple local IP addresses to one global IP address. This is equivalent to SUA (i.e., PAT, port address translation), ZyXEL's Single User Account feature that previous ZyXEL routers supported only. • Many-to-Many Overload: Many-to-Many Overload mode maps multiple local IP addresses to shared global IP addresses. • Many-to-Many No Overload: Many-to-Many No Overload mode maps each local IP address to unique global IP addresses. • Server: This type allows you to specify inside servers of different services behind the NAT to be accessible to the outside world.
Local Start IP	This is the starting local IP address (ILA). Local IP addresses are N/A for Server port mapping.
Local End IP	This is the end local IP address (ILA). If your rule is for all local IP addresses, then enter 0.0.0.0 as the Local Start IP address and 255.255.255.255 as the Local End IP address. This field is N/A for One-to-One and Server mapping types.
Global Start IP	This is the starting global IP address (IGA). Enter 0.0.0.0 here if you have a dynamic IP address from your ISP.
Global End IP	This is the ending global IP address (IGA). This field is N/A for One-to-One , Many-to-One and Server mapping types.
Server Mapping Set	Only available when Type is set to Server . Select a number from the drop-down menu to choose a server mapping set.

Table 51 Edit Address Mapping Rule (continued)

LABEL	DESCRIPTION
Edit Details	Click this link to go to the Port Forwarding screen to edit a server mapping set that you have selected in the Server Mapping Set field.
Back	Click Back to return to the previous screen.
Apply	Click Apply to save your changes back to the ZyXEL Device.
Cancel	Click Cancel to begin configuring this screen afresh.

CHAPTER 9

Firewalls

This chapter gives some background information on firewalls and introduces the ZyXEL Device firewall.

9.1 Firewall Overview

Originally, the term *firewall* referred to a construction technique designed to prevent the spread of fire from one room to another. The networking term “firewall” is a system or group of systems that enforces an access-control policy between two networks. It may also be defined as a mechanism used to protect a trusted network from an untrusted network. Of course, firewalls cannot solve every security problem. A firewall is *one* of the mechanisms used to establish a network security perimeter in support of a network security policy. It should never be the *only* mechanism or method employed. For a firewall to guard effectively, you must design and deploy it appropriately. This requires integrating the firewall into a broad information-security policy. In addition, specific policies must be implemented within the firewall itself.

Refer to [Section 10.5 on page 159](#) to configure default firewall settings.

Refer to [Section 10.6 on page 160](#) to view firewall rules.

Refer to [Section 10.6.1 on page 162](#) to configure firewall rules.

Refer to [Section 10.6.2 on page 165](#) to configure a custom service.

Refer to [Section 10.10.3 on page 175](#) to configure firewall thresholds.

9.2 Types of Firewalls

There are three main types of firewalls:

- Packet Filtering Firewalls
- Application-level Firewalls
- Stateful Inspection Firewalls

9.2.1 Packet Filtering Firewalls

Packet filtering firewalls restrict access based on the source/destination computer network address of a packet and the type of application.

9.2.2 Application-level Firewalls

Application-level firewalls restrict access by serving as proxies for external servers. Since they use programs written for specific Internet services, such as HTTP, FTP and telnet, they can evaluate network packets for valid application-specific data. Application-level gateways have a number of general advantages over the default mode of permitting application traffic directly to internal hosts:

Information hiding prevents the names of internal systems from being made known via DNS to outside systems, since the application gateway is the only host whose name must be made known to outside systems.

Robust authentication and logging pre-authenticates application traffic before it reaches internal hosts and causes it to be logged more effectively than if it were logged with standard host logging. Filtering rules at the packet filtering router can be less complex than they would be if the router needed to filter application traffic and direct it to a number of specific systems. The router need only allow application traffic destined for the application gateway and reject the rest.

9.2.3 Stateful Inspection Firewalls

Stateful inspection firewalls restrict access by screening data packets against defined access rules. They make access control decisions based on IP address and protocol. They also "inspect" the session data to assure the integrity of the connection and to adapt to dynamic protocols. These firewalls generally provide the best speed and transparency, however, they may lack the granular application level access control or caching that some proxies support. See [Section 9.5 on page 150](#) for more information on stateful inspection.

Firewalls, of one type or another, have become an integral part of standard security solutions for enterprises.

9.3 Introduction to ZyXEL's Firewall

The ZyXEL Device firewall is a stateful inspection firewall and is designed to protect against Denial of Service attacks when activated. The ZyXEL Device's purpose is to allow a private Local Area Network (LAN) to be securely connected to the Internet. The ZyXEL Device can be used to prevent theft, destruction and modification of data, as well as log events, which may be important to the security of your network. The ZyXEL Device also has packet filtering capabilities.

The ZyXEL Device is installed between the LAN and the Internet. This allows it to act as a secure gateway for all data passing between the Internet and the LAN.

The ZyXEL Device has one DSL/ISDN port and one Ethernet LAN port, which physically separate the network into two areas.

- The DSL/ISDN port connects to the Internet.

- The LAN (Local Area Network) port attaches to a network of computers, which needs security from the outside world. These computers will have access to Internet services such as e-mail, FTP, and the World Wide Web. However, “inbound access” will not be allowed unless you configure remote management or create a firewall rule to allow a remote host to use a specific service.

9.3.1 Denial of Service Attacks

Figure 81 Firewall Application

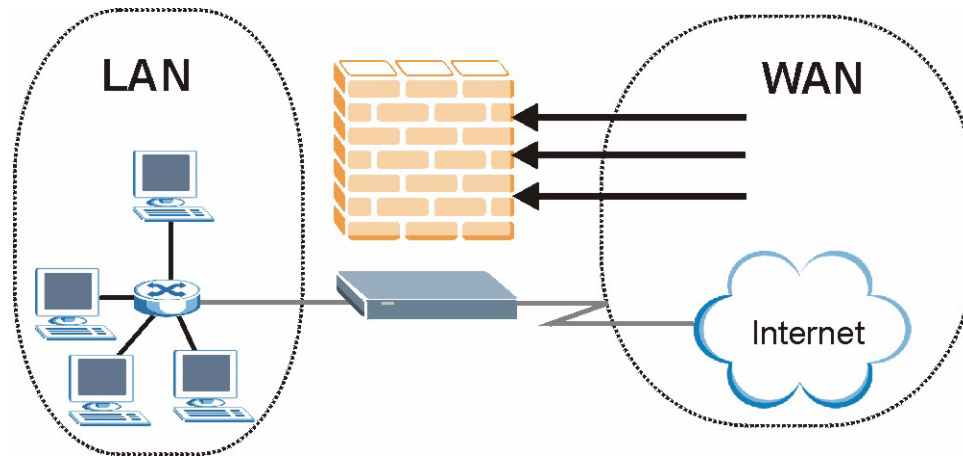

9.4 Denial of Service

Denials of Service (DoS) attacks are aimed at devices and networks with a connection to the Internet. Their goal is not to steal information, but to disable a device or network so users no longer have access to network resources. The ZyXEL Device is pre-configured to automatically detect and thwart all known DoS attacks.

9.4.1 Basics

Computers share information over the Internet using a common language called TCP/IP. TCP/IP, in turn, is a set of application protocols that perform specific functions. An “extension number”, called the “TCP port” or “UDP port” identifies these protocols, such as HTTP (Web), FTP (File Transfer Protocol), POP3 (E-mail), etc. For example, Web traffic by default uses TCP port 80.

When computers communicate on the Internet, they are using the client/server model, where the server “listens” on a specific TCP/UDP port for information requests from remote client computers on the network. For example, a Web server typically listens on port 80. Please note that while a computer may be intended for use over a single port, such as Web on port 80, other ports are also active. If the person configuring or managing the computer is not careful, a hacker could attack it over an unprotected port.

Some of the most common IP ports are:

Table 52 Common IP Ports

21	FTP	53	DNS
23	Telnet	80	HTTP
25	SMTP	110	POP3

9.4.2 Types of DoS Attacks

There are four types of DoS attacks:

- 1 Those that exploit bugs in a TCP/IP implementation.
- 2 Those that exploit weaknesses in the TCP/IP specification.
- 3 Brute-force attacks that flood a network with useless data.
- 4 IP Spoofing.
- 5 **"Ping of Death"** and **"Teardrop"** attacks exploit bugs in the TCP/IP implementations of various computer and host systems.
 - Ping of Death uses a "ping" utility to create an IP packet that exceeds the maximum 65,536 bytes of data allowed by the IP specification. The oversize packet is then sent to an unsuspecting system. Systems may crash, hang or reboot.
 - Teardrop attack exploits weaknesses in the re-assembly of IP packet fragments. As data is transmitted through a network, IP packets are often broken up into smaller chunks. Each fragment looks like the original IP packet except that it contains an offset field that says, for instance, "This fragment is carrying bytes 200 through 400 of the original (non fragmented) IP packet." The Teardrop program creates a series of IP fragments with overlapping offset fields. When these fragments are reassembled at the destination, some systems will crash, hang, or reboot.
- 6 Weaknesses in the TCP/IP specification leave it open to **"SYN Flood"** and **"LAND"** attacks. These attacks are executed during the handshake that initiates a communication session between two applications.

Figure 82 Three-Way Handshake

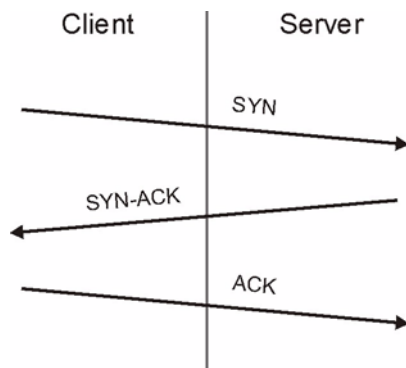

Under normal circumstances, the application that initiates a session sends a SYN (synchronize) packet to the receiving server. The receiver sends back an ACK (acknowledgment) packet and its own SYN, and then the initiator responds with an ACK (acknowledgment). After this handshake, a connection is established.

- **SYN Attack** floods a targeted system with a series of SYN packets. Each packet causes the targeted system to issue a SYN-ACK response. While the targeted system waits for the ACK that follows the SYN-ACK, it queues up all outstanding SYN-ACK responses on what is known as a backlog queue. SYN-ACKs are moved off the queue only when an ACK comes back or when an internal timer (which is set at relatively long intervals) terminates the three-way handshake. Once the queue is full, the system will ignore all incoming SYN requests, making the system unavailable for legitimate users.

Figure 83 SYN Flood

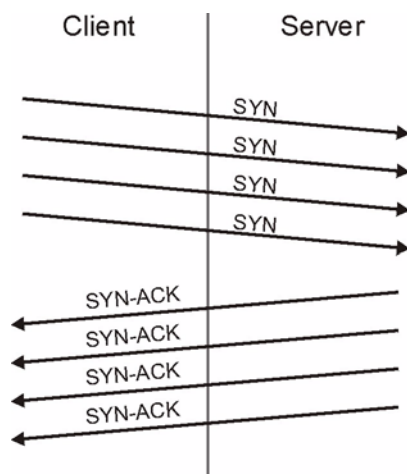

- In a **LAND Attack**, hackers flood SYN packets into the network with a spoofed source IP address of the targeted system. This makes it appear as if the host computer sent the packets to itself, making the system unavailable while the target system tries to respond to itself.
- 7** A **brute-force** attack, such as a "Smurf" attack, targets a feature in the IP specification known as directed or subnet broadcasting, to quickly flood the target network with useless data. A Smurf hacker floods a router with Internet Control Message Protocol (ICMP) echo request packets (pings). Since the destination IP address of each packet is the broadcast address of the network, the router will broadcast the ICMP echo request packet to all hosts on the network. If there are numerous hosts, this will create a large amount of ICMP echo request and response traffic. If a hacker chooses to spoof the source IP address of the ICMP echo request packet, the resulting ICMP traffic will not only clog up the "intermediary" network, but will also congest the network of the spoofed source IP address, known as the "victim" network. This flood of broadcast traffic consumes all available bandwidth, making communications impossible.

Figure 84 Smurf Attack

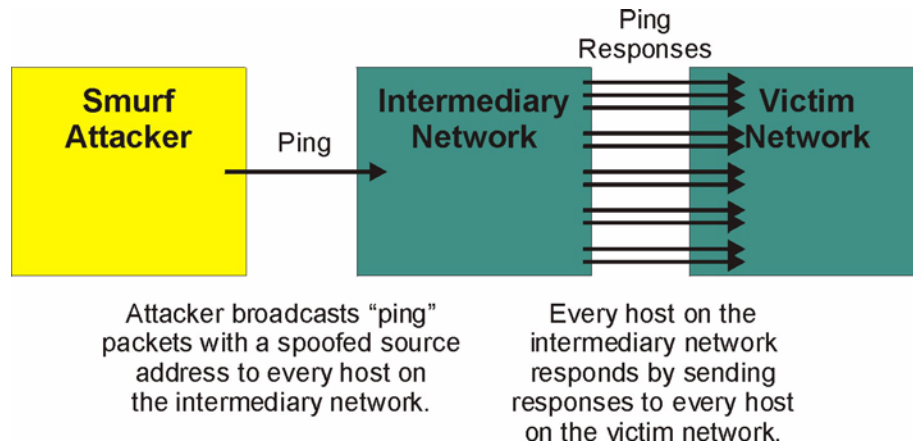

9.4.2.1 ICMP Vulnerability

ICMP is an error-reporting protocol that works in concert with IP. The following ICMP types trigger an alert:

Table 53 ICMP Commands That Trigger Alerts

5	REDIRECT
13	TIMESTAMP_REQUEST
14	TIMESTAMP_REPLY
17	ADDRESS_MASK_REQUEST
18	ADDRESS_MASK_REPLY

9.4.2.2 Illegal Commands (NetBIOS and SMTP)

The only legal NetBIOS commands are the following - all others are illegal.

Table 54 Legal NetBIOS Commands

MESSAGE:
REQUEST:
POSITIVE:
VE:
RETARGET:
KEEPALIVE:

All SMTP commands are illegal except for those displayed in the following tables.

Table 55 Legal SMTP Commands

AUTH	DATA	EHLO	ETRNL	EXPN	HELO	HELP	MAIL	NOOP
QUIT	RCPT	RSET	SAML	SEND	SOML	TURN	VERFY	

9.4.2.3 Traceroute

Traceroute is a utility used to determine the path a packet takes between two endpoints. Sometimes when a packet filter firewall is configured incorrectly an attacker can traceroute the firewall gaining knowledge of the network topology inside the firewall.

Often, many DoS attacks also employ a technique known as "**IP Spoofing**" as part of their attack. IP Spoofing may be used to break into systems, to hide the hacker's identity, or to magnify the effect of the DoS attack. IP Spoofing is a technique used to gain unauthorized access to computers by tricking a router or firewall into thinking that the communications are coming from within the trusted network. To engage in IP spoofing, a hacker must modify the packet headers so that it appears that the packets originate from a trusted host and should be allowed through the router or firewall. The ZyXEL Device blocks all IP Spoofing attempts.

9.5 Stateful Inspection

With stateful inspection, fields of the packets are compared to packets that are already known to be trusted. For example, if you access some outside service, the proxy server remembers things about your original request, like the port number and source and destination addresses. This "remembering" is called *saving the state*. When the outside system responds to your request, the firewall compares the received packets with the saved state to determine if they are allowed in. The ZyXEL Device uses stateful packet inspection to protect the private LAN from hackers and vandals on the Internet. By default, the ZyXEL Device's stateful inspection allows all communications to the Internet that originate from the LAN, and blocks all traffic to the LAN that originates from the Internet. In summary, stateful inspection:

- Allows all sessions originating from the LAN (local network) to the WAN (Internet).
- Denies all sessions originating from the WAN to the LAN.

Figure 85 Stateful Inspection

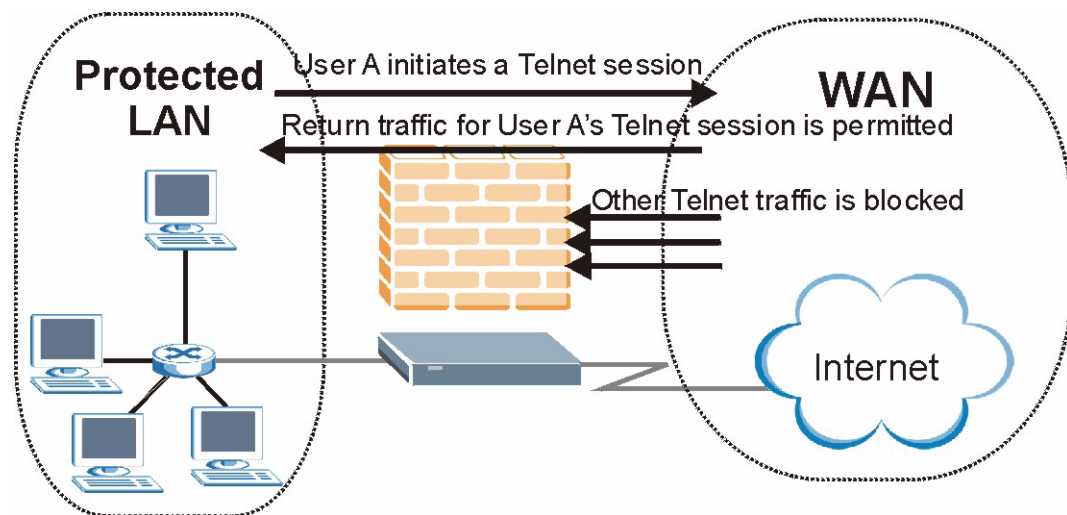

The previous figure shows the ZyXEL Device's default firewall rules in action as well as demonstrates how stateful inspection works. User A can initiate a Telnet session from within the LAN and responses to this request are allowed. However other Telnet traffic initiated from the WAN is blocked.

9.5.1 Stateful Inspection Process

In this example, the following sequence of events occurs when a TCP packet leaves the LAN network through the firewall's WAN interface. The TCP packet is the first in a session, and the packet's application layer protocol is configured for a firewall rule inspection:

- 1 The packet travels from the firewall's LAN to the WAN.
- 2 The packet is evaluated against the interface's existing outbound access list, and the packet is permitted (a denied packet would simply be dropped at this point).
- 3 The packet is inspected by a firewall rule to determine and record information about the state of the packet's connection. This information is recorded in a new state table entry created for the new connection. If there is not a firewall rule for this packet and it is not an attack, then the settings in the **Firewall General** screen determine the action for this packet.
- 4 Based on the obtained state information, a firewall rule creates a temporary access list entry that is inserted at the beginning of the WAN interface's inbound extended access list. This temporary access list entry is designed to permit inbound packets of the same connection as the outbound packet just inspected.
- 5 The outbound packet is forwarded out through the interface.
- 6 Later, an inbound packet reaches the interface. This packet is part of the connection previously established with the outbound packet. The inbound packet is evaluated against the inbound access list, and is permitted because of the temporary access list entry previously created.
- 7 The packet is inspected by a firewall rule, and the connection's state table entry is updated as necessary. Based on the updated state information, the inbound extended access list temporary entries might be modified, in order to permit only packets that are valid for the current state of the connection.
- 8 Any additional inbound or outbound packets that belong to the connection are inspected to update the state table entry and to modify the temporary inbound access list entries as required, and are forwarded through the interface.
- 9 When the connection terminates or times out, the connection's state table entry is deleted and the connection's temporary inbound access list entries are deleted.

9.5.2 Stateful Inspection and the ZyXEL Device

Additional rules may be defined to extend or override the default rules. For example, a rule may be created which will:

- Block all traffic of a certain type, such as IRC (Internet Relay Chat), from the LAN to the Internet.

- Allow certain types of traffic from the Internet to specific hosts on the LAN.
- Allow access to a Web server to everyone but competitors.
- Restrict use of certain protocols, such as Telnet, to authorized users on the LAN.

These custom rules work by evaluating the network traffic's Source IP address, Destination IP address, IP protocol type, and comparing these to rules set by the administrator.

Note: The ability to define firewall rules is a very powerful tool. Using custom rules, it is possible to disable all firewall protection or block all access to the Internet. Use extreme caution when creating or deleting firewall rules. Test changes after creating them to make sure they work correctly.

Below is a brief technical description of how these connections are tracked. Connections may either be defined by the upper protocols (for instance, TCP), or by the ZyXEL Device itself (as with the "virtual connections" created for UDP and ICMP).

9.5.3 TCP Security

The ZyXEL Device uses state information embedded in TCP packets. The first packet of any new connection has its SYN flag set and its ACK flag cleared; these are "initiation" packets. All packets that do not have this flag structure are called "subsequent" packets, since they represent data that occurs later in the TCP stream.

If an initiation packet originates on the WAN, this means that someone is trying to make a connection from the Internet into the LAN. Except in a few special cases (see "Upper Layer Protocols" shown next), these packets are dropped and logged.

If an initiation packet originates on the LAN, this means that someone is trying to make a connection from the LAN to the Internet. Assuming that this is an acceptable part of the security policy (as is the case with the default policy), the connection will be allowed. A cache entry is added which includes connection information such as IP addresses, TCP ports, sequence numbers, etc.

When the ZyXEL Device receives any subsequent packet (from the Internet or from the LAN), its connection information is extracted and checked against the cache. A packet is only allowed to pass through if it corresponds to a valid connection (that is, if it is a response to a connection which originated on the LAN).

9.5.4 UDP/ICMP Security

UDP and ICMP do not themselves contain any connection information (such as sequence numbers). However, at the very minimum, they contain an IP address pair (source and destination). UDP also contains port pairs, and ICMP has type and code information. All of this data can be analyzed in order to build "virtual connections" in the cache.

For instance, any UDP packet that originates on the LAN will create a cache entry. Its IP address and port pairs will be stored. For a short period of time, UDP packets from the WAN that have matching IP and UDP information will be allowed back in through the firewall.

A similar situation exists for ICMP, except that the ZyXEL Device is even more restrictive. Specifically, only outgoing echoes will allow incoming echo replies, outgoing address mask requests will allow incoming address mask replies, and outgoing timestamp requests will allow incoming timestamp replies. No other ICMP packets are allowed in through the firewall, simply because they are too dangerous and contain too little tracking information. For instance, ICMP redirect packets are never allowed in, since they could be used to reroute traffic through attacking machines.

9.5.5 Upper Layer Protocols

Some higher layer protocols (such as FTP and RealAudio) utilize multiple network connections simultaneously. In general terms, they usually have a "control connection" which is used for sending commands between endpoints, and then "data connections" which are used for transmitting bulk information.

Consider the FTP protocol. A user on the LAN opens a control connection to a server on the Internet and requests a file. At this point, the remote server will open a data connection from the Internet. For FTP to work properly, this connection must be allowed to pass through even though a connection from the Internet would normally be rejected.

In order to achieve this, the ZyXEL Device inspects the application-level FTP data. Specifically, it searches for outgoing "PORT" commands, and when it sees these, it adds a cache entry for the anticipated data connection. This can be done safely, since the PORT command contains address and port information, which can be used to uniquely identify the connection.

Any protocol that operates in this way must be supported on a case-by-case basis. You can use the web configurator's Custom Ports feature to do this.

9.6 Guidelines for Enhancing Security with Your Firewall

- Change the default password via CLI (Command Line Interpreter) or web configurator.
- Limit who can telnet into your router.
- Don't enable any local service (such as SNMP or NTP) that you don't use. Any enabled service could present a potential security risk. A determined hacker might be able to find creative ways to misuse the enabled services to access the firewall or the network.
- For local services that are enabled, protect against misuse. Protect by configuring the services to communicate only with specific peers, and protect by configuring rules to block packets for the services at specific interfaces.
- Protect against IP spoofing by making sure the firewall is active.
- Keep the firewall in a secured (locked) room.

9.6.1 Security In General

You can never be too careful! Factors outside your firewall, filtering or NAT can cause security breaches. Below are some generalizations about what you can do to minimize them.

- Encourage your company or organization to develop a comprehensive security plan. Good network administration takes into account what hackers can do and prepares against attacks. The best defense against hackers and crackers is information. Educate all employees about the importance of security and how to minimize risk. Produce lists like this one!
- DSL or cable modem connections are “always-on” connections and are particularly vulnerable because they provide more opportunities for hackers to crack your system. Turn your computer off when not in use.
- Never give out a password or any sensitive information to an unsolicited telephone call or e-mail.
- Never e-mail sensitive information such as passwords, credit card information, etc., without encrypting the information first.
- Never submit sensitive information via a web page unless the web site uses secure connections. You can identify a secure connection by looking for a small “key” icon on the bottom of your browser (Internet Explorer 3.02 or better or Netscape 3.0 or better). If a web site uses a secure connection, it is safe to submit information. Secure web transactions are quite difficult to crack.
- Never reveal your IP address or other system networking information to people outside your company. Be careful of files e-mailed to you from strangers. One common way of getting BackOrifice on a system is to include it as a Trojan horse with other files.
- Change your passwords regularly. Also, use passwords that are not easy to figure out. The most difficult passwords to crack are those with upper and lower case letters, numbers and a symbol such as % or #.
- Upgrade your software regularly. Many older versions of software, especially web browsers, have well known security deficiencies. When you upgrade to the latest versions, you get the latest patches and fixes.
- If you use “chat rooms” or IRC sessions, be careful with any information you reveal to strangers.
- If your system starts exhibiting odd behavior, contact your ISP. Some hackers will set off hacks that cause your system to slowly become unstable or unusable.
- Always shred confidential information, particularly about your computer, before throwing it away. Some hackers dig through the trash of companies or individuals for information that might help them in an attack.

9.7 Packet Filtering Vs Firewall

Below are some comparisons between the ZyXEL Device’s filtering and firewall functions.

9.7.1 Packet Filtering:

- The router filters packets as they pass through the router’s interface according to the filter rules you designed.
- Packet filtering is a powerful tool, yet can be complex to configure and maintain, especially if you need a chain of rules to filter a service.
- Packet filtering only checks the header portion of an IP packet.

9.7.1.1 When To Use Filtering

- To block/allow LAN packets by their MAC addresses.
- To block/allow special IP packets which are neither TCP nor UDP, nor ICMP packets.
- To block/allow both inbound (WAN to LAN) and outbound (LAN to WAN) traffic between the specific inside host/network "A" and outside host/network "B". If the filter blocks the traffic from A to B, it also blocks the traffic from B to A. Filters can not distinguish traffic originating from an inside host or an outside host by IP address.
- To block/allow IP trace route.

9.7.2 Firewall

- The firewall inspects packet contents as well as their source and destination addresses. Firewalls of this type employ an inspection module, applicable to all protocols, that understands data in the packet is intended for other layers, from the network layer (IP headers) up to the application layer.
- The firewall performs stateful inspection. It takes into account the state of connections it handles so that, for example, a legitimate incoming packet can be matched with the outbound request for that packet and allowed in. Conversely, an incoming packet masquerading as a response to a nonexistent outbound request can be blocked.
- The firewall uses session filtering, i.e., smart rules, that enhance the filtering process and control the network session rather than control individual packets in a session.
- The firewall provides e-mail service to notify you of routine reports and when alerts occur.

9.7.2.1 When To Use The Firewall

- To prevent DoS attacks and prevent hackers cracking your network.
- A range of source and destination IP addresses as well as port numbers can be specified within one firewall rule making the firewall a better choice when complex rules are required.
- To selectively block/allow inbound or outbound traffic between inside host/networks and outside host/networks. Remember that filters can not distinguish traffic originating from an inside host or an outside host by IP address.
- The firewall performs better than filtering if you need to check many rules.
- Use the firewall if you need routine e-mail reports about your system or need to be alerted when attacks occur.
- The firewall can block specific URL traffic that might occur in the future. The URL can be saved in an Access Control List (ACL) database.

CHAPTER 10

Firewall Configuration

This chapter shows you how to enable and configure the ZyXEL Device firewall.

10.1 Access Methods

The web configurator is, by far, the most comprehensive firewall configuration tool your ZyXEL Device has to offer. For this reason, it is recommended that you configure your firewall using the web configurator. CLI (Command Line Interpreter) commands provide limited configuration options and are only recommended for advanced users.

10.2 Firewall Policies Overview

Firewall rules are grouped based on the direction of travel of packets to which they apply:

- LAN to LAN/ Router
- LAN to WAN
- WAN to LAN
- WAN to WAN/ Router

Note: The LAN includes both the LAN port and the WLAN.

By default, the ZyXEL Device's stateful packet inspection allows packets traveling in the following directions:

- LAN to LAN/ Router
This allows computers on the LAN to manage the ZyXEL Device and communicate between networks or subnets connected to the LAN interface.
- LAN to WAN

By default, the ZyXEL Device's stateful packet inspection drops packets traveling in the following directions:

- WAN to LAN
- WAN to WAN/ Router

This prevents computers on the WAN from using the ZyXEL Device as a gateway to communicate with other computers on the WAN and/or managing the ZyXEL Device.

You may define additional rules and sets or modify existing ones but please exercise extreme caution in doing so.

Note: If you configure firewall rules without a good understanding of how they work, you might inadvertently introduce security risks to the firewall and to the protected network. Make sure you test your rules after you configure them.

For example, you may create rules to:

- Block certain types of traffic, such as IRC (Internet Relay Chat), from the LAN to the Internet.
- Allow certain types of traffic, such as Lotus Notes database synchronization, from specific hosts on the Internet to specific hosts on the LAN.
- Allow everyone except your competitors to access a Web server.
- Restrict use of certain protocols, such as Telnet, to authorized users on the LAN.

These custom rules work by comparing the Source IP address, Destination IP address and IP protocol type of network traffic to rules set by the administrator. Your customized rules take precedence and override the ZyXEL Device's default rules.

10.3 Rule Logic Overview

Note: Study these points carefully before configuring rules.

10.3.1 Rule Checklist

State the intent of the rule. For example, "This restricts all IRC access from the LAN to the Internet." Or, "This allows a remote Lotus Notes server to synchronize over the Internet to an inside Notes server."

- 1 Is the intent of the rule to forward or block traffic?
- 2 What direction of traffic does the rule apply to?
- 3 What IP services will be affected?
- 4 What computers on the LAN are to be affected (if any)?
- 5 What computers on the Internet will be affected? The more specific, the better. For example, if traffic is being allowed from the Internet to the LAN, it is better to allow only certain machines on the Internet to access the LAN.

10.3.2 Security Ramifications

- 1 Once the logic of the rule has been defined, it is critical to consider the security ramifications created by the rule:
- 2 Does this rule stop LAN users from accessing critical resources on the Internet? For example, if IRC is blocked, are there users that require this service?
- 3 Is it possible to modify the rule to be more specific? For example, if IRC is blocked for all users, will a rule that blocks just certain users be more effective?

- 4 Does a rule that allows Internet users access to resources on the LAN create a security vulnerability? For example, if FTP ports (TCP 20, 21) are allowed from the Internet to the LAN, Internet users may be able to connect to computers with running FTP servers.
- 5 Does this rule conflict with any existing rules?
- 6 Once these questions have been answered, adding rules is simply a matter of plugging the information into the correct fields in the web configurator screens.

10.3.3 Key Fields For Configuring Rules

10.3.3.1 Action

Should the action be to **Drop**, **Reject** or **Permit**?

Note: “Drop” means the firewall silently discards the packet. “Reject” means the firewall discards packets and sends an ICMP destination-unreachable message to the sender.

10.3.3.2 Service

Select the service from the **Service** scrolling list box. If the service is not listed, it is necessary to first define it. See [Section 10.8 on page 170](#) for more information on predefined services.

10.3.3.3 Source Address

What is the connection's source address; is it on the LAN or WAN? Is it a single IP, a range of IPs or a subnet?

10.3.3.4 Destination Address

What is the connection's destination address; is it on the LAN or WAN? Is it a single IP, a range of IPs or a subnet?

10.4 Connection Direction

This section describes examples for firewall rules for connections going from LAN to WAN and from WAN to LAN.

LAN to LAN/ Router and WAN to WAN/ Router rules apply to packets coming in on the associated interface (LAN or WAN respectively). LAN to LAN/ Router means policies for LAN-to-ZyXEL Device (the policies for managing the ZyXEL Device through the LAN interface) and policies for LAN-to-LAN (the policies that control routing between two subnets on the LAN). Similarly, WAN to WAN/ Router policies apply in the same way to the WAN port.

10.4.1 LAN to WAN Rules

The default rule for LAN to WAN traffic is that all users on the LAN are allowed non-restricted access to the WAN. When you configure a LAN to WAN rule, you in essence want to limit some or all users from accessing certain services on the WAN. WAN to LAN Rules

The default rule for WAN to LAN traffic blocks all incoming connections (WAN to LAN). If you wish to allow certain WAN users to have access to your LAN, you will need to create custom rules to allow it.

10.4.2 Alerts

Alerts are reports on events, such as attacks, that you may want to know about right away. You can choose to generate an alert when a rule is matched in the **Edit Rule** screen (see [Figure 88 on page 163](#)). When an event generates an alert, a message can be immediately sent to an e-mail account that you specify in the **Log Settings** screen. Refer to the chapter on logs for details

10.5 General Firewall Policy

Click **Security > Firewall** to display the following screen. Activate the firewall by selecting the **Active Firewall** check box as seen in the following screen.

Refer to [Section 9.1 on page 144](#) for more information.

Figure 86 Firewall: General

General Rules Anti Probing Threshold

General

Active Firewall
 Bypass Triangle Route

Caution:
When Bypass Triangle Route is checked, all LAN to LAN and WAN to WAN packets will bypass the Firewall check.

Packet Direction	Default Action	Log
WAN to LAN	Drop	<input checked="" type="checkbox"/>
LAN to WAN	Permit	<input checked="" type="checkbox"/>
WAN to WAN / Router	Drop	<input checked="" type="checkbox"/>
LAN to LAN / Router	Permit	<input type="checkbox"/>

[Basic...](#)

Apply Cancel

The following table describes the labels in this screen.

Table 56 Firewall: General

LABEL	DESCRIPTION
Active Firewall	Select this check box to activate the firewall. The ZyXEL Device performs access control and protects against Denial of Service (DoS) attacks when the firewall is activated.
Bypass Triangle Route	<p>Select this check box to have the ZyXEL Device firewall permit the use of triangle route topology on the network. See the appendix for more on triangle route topology.</p> <p>Note: Allowing asymmetrical routes may let traffic from the WAN go directly to a LAN computer without passing through the router. See Appendix N on page 350 for more on triangle route topology and how to deal with this problem.</p>
Packet Direction	<p>This is the direction of travel of packets (LAN to LAN / Router, LAN to WAN, WAN to WAN / Router, WAN to LAN).</p> <p>Firewall rules are grouped based on the direction of travel of packets to which they apply. For example, LAN to LAN / Router means packets traveling from a computer/subnet on the LAN to either another computer/subnet on the LAN interface of the ZyXEL Device or the ZyXEL Device itself.</p>
Default Action	<p>Use the drop-down list boxes to select the default action that the firewall is take on packets that are traveling in the selected direction and do not match any of the firewall rules.</p> <p>Select Drop to silently discard the packets without sending a TCP reset packet or an ICMP destination-unreachable message to the sender.</p> <p>Select Reject to deny the packets and send a TCP reset packet (for a TCP packet) or an ICMP destination-unreachable message (for a UDP packet) to the sender.</p> <p>Select Permit to allow the passage of the packets.</p>
Log	Select the check box to create a log (when the above action is taken) for packets that are traveling in the selected direction and do not match any of your customized rules.
Expand...	Click this button to display more information.
Basic...	Click this button to display less information.
Apply	Click Apply to save your changes back to the ZyXEL Device.
Cancel	Click Cancel to begin configuring this screen afresh.

10.6 Firewall Rules Summary

Note: The ordering of your rules is very important as rules are applied in turn.

Refer to [Section 9.1 on page 144](#) for more information.

Click **Security > Firewall > Rules** to bring up the following screen. This screen displays a list of the configured firewall rules. Note the order in which the rules are listed.

Figure 87 Firewall Rules

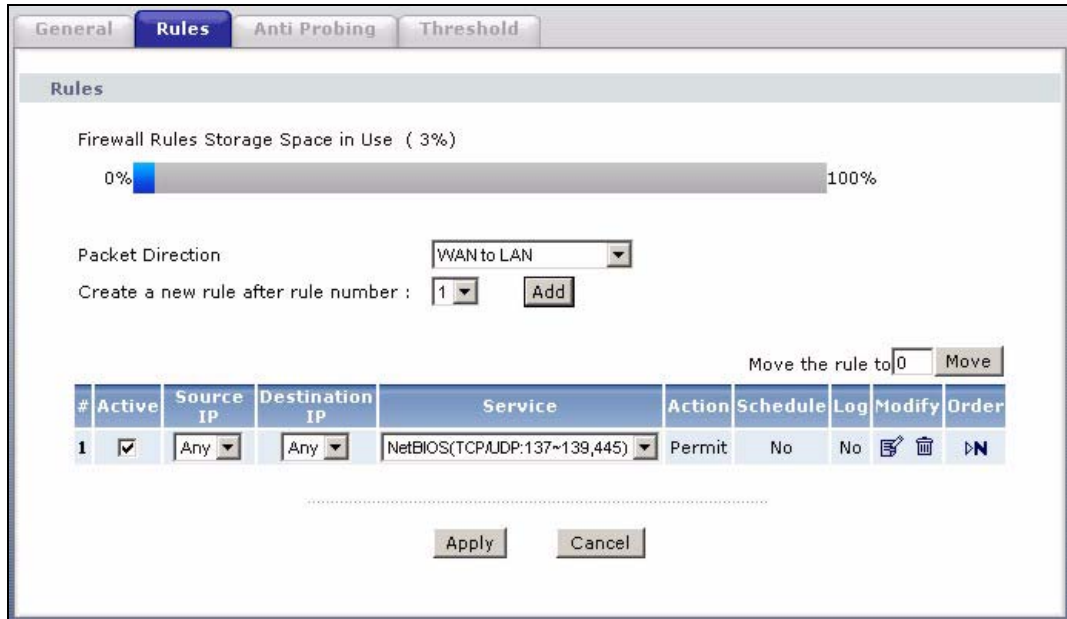

The following table describes the labels in this screen.

Table 57 Firewall Rules

LABEL	DESCRIPTION
Firewall Rules Storage Space in Use	This read-only bar shows how much of the ZyXEL Device's memory for recording firewall rules it is currently using. When you are using 80% or less of the storage space, the bar is green. When the amount of space used is over 80%, the bar is red.
Packet Direction	Use the drop-down list box to select a direction of travel of packets for which you want to configure firewall rules.
Create a new rule after rule number	Select an index number and click Add to add a new firewall rule after the selected index number. For example, if you select "6", your new rule becomes number 7 and the previous rule 7 (if there is one) becomes rule 8.
	The following read-only fields summarize the rules you have created that apply to traffic traveling in the selected packet direction. The firewall rules that you configure (summarized below) take priority over the general firewall action settings in the General screen.
#	This is your firewall rule number. The ordering of your rules is important as rules are applied in turn.
Active	This field displays whether a firewall is turned on or not. Select the check box to enable the rule. Clear the check box to disable the rule.
Source IP	This drop-down list box displays the source addresses or ranges of addresses to which this firewall rule applies. Please note that a blank source or destination address is equivalent to Any .
Destination IP	This drop-down list box displays the destination addresses or ranges of addresses to which this firewall rule applies. Please note that a blank source or destination address is equivalent to Any .
Service	This drop-down list box displays the services to which this firewall rule applies. See Section 10.8 on page 170 for more information.

Table 57 Firewall Rules (continued)

LABEL	DESCRIPTION
Action	This field displays whether the firewall silently discards packets (Drop), discards packets and sends a TCP reset packet or an ICMP destination-unreachable message to the sender (Reject) or allows the passage of packets (Permit)
Schedule	This field tells you whether a schedule is specified (Yes) or not (No).
Log	This field shows you whether a log is created when packets match this rule (Yes) or not (No).
Modify	Click the Edit icon to go to the screen where you can edit the rule. Click the Remove icon to delete an existing firewall rule. A window displays asking you to confirm that you want to delete the firewall rule. Note that subsequent firewall rules move up by one when you take this action.
Order	Click the Move icon to display the Move the rule to field. Type a number in the Move the rule to field and click the Move button to move the rule to the number that you typed. The ordering of your rules is important as they are applied in order of their numbering.
Apply	Click Apply to save your changes back to the ZyXEL Device.
Cancel	Click Cancel to begin configuring this screen afresh.

10.6.1 Configuring Firewall Rules

Refer to [Section 9.1 on page 144](#) for more information.

In the **Rules** screen, select an index number and click **Add** or click a rule's Edit icon to display this screen and refer to the following table for information on the labels.

Figure 88 Firewall: Edit Rule

Edit Rule 2

Active
 Action for Matched Packets: Permit

Source Address

Address Type: Any Address

Start IP Address: 0.0.0.0 Add >>

End IP Address: 0.0.0.0 Edit <<

Subnet Mask: 0.0.0.0 Delete

Source Address List

Any

Destination Address

Address Type: Any Address

Start IP Address: 0.0.0.0 Add >>

End IP Address: 0.0.0.0 Edit <<

Subnet Mask: 0.0.0.0 Delete

Destination Address List

Any

Service

Available Services

Any(All)
 Any(ICMP)
 AIMNEW-ICQ(TCP:5190)
 AUTH(TCP:113)
 BGP(TCP:179)

Selected Services

Any(UDP)
 Any(TCP)

Add >> Remove

[Edit Customized Services](#)

Schedule

Day to Apply

Everyday

Sun Mon Tue Wed Thu Fri Sat

Time of Day to Apply : (24-Hour Format)

All day

Start hour minute End hour minute

Log

Log Packet Detail Information.

Alert

Send Alert Message to Administrator When Matched.

.....

Apply Cancel

The following table describes the labels in this screen.

Table 58 Firewall: Edit Rule

LABEL	DESCRIPTION
Active	Select this option to enable this firewall rule.
Action for Matched Packet	Use the drop-down list box to select what the firewall is to do with packets that match this rule. Select Drop to silently discard the packets without sending a TCP reset packet or an ICMP destination-unreachable message to the sender. Select Reject to deny the packets and send a TCP reset packet (for a TCP packet) or an ICMP destination-unreachable message (for a UDP packet) to the sender. Select Permit to allow the passage of the packets.
Source/Destination Address	
Address Type	Do you want your rule to apply to packets with a particular (single) IP, a range of IP addresses (e.g., 192.168.1.10 to 192.169.1.50), a subnet or any IP address? Select an option from the drop-down list box that includes: Single Address , Range Address , Subnet Address and Any Address .
Start IP Address	Enter the single IP address or the starting IP address in a range here.
End IP Address	Enter the ending IP address in a range here.
Subnet Mask	Enter the subnet mask here, if applicable.
Add >>	Click Add >> to add a new address to the Source or Destination Address box. You can add multiple addresses, ranges of addresses, and/or subnets.
Edit <<	To edit an existing source or destination address, select it from the box and click Edit << .
Delete	Highlight an existing source or destination address from the Source or Destination Address box above and click Delete to remove it.
Services	
Available/ Selected Services	Please see Section 10.8 on page 170 for more information on services available. Highlight a service from the Available Services box on the left, then click Add >> to add it to the Selected Services box on the right. To remove a service, highlight it in the Selected Services box on the right, then click Remove .
Edit Customized Service	Click the Edit Customized Services link to bring up the screen that you use to configure a new custom service that is not in the predefined list of services.
Schedule	
Day to Apply	Select everyday or the day(s) of the week to apply the rule.
Time of Day to Apply (24-Hour Format)	Select All Day or enter the start and end times in the hour-minute format to apply the rule.
Log	
Log Packet Detail Information	This field determines if a log for packets that match the rule is created or not. Go to the Log Settings page and select the Access Control logs category to have the ZyXEL Device record these logs.
Alert	
Send Alert Message to Administrator When Matched	Select the check box to have the ZyXEL Device generate an alert when the rule is matched.

Table 58 Firewall: Edit Rule (continued)

LABEL	DESCRIPTION
Apply	Click Apply to save your customized settings and exit this screen.
Cancel	Click Cancel to exit this screen without saving.

10.6.2 Customized Services

Configure customized services and port numbers not predefined by the ZyXEL Device. For a comprehensive list of port numbers and services, visit the IANA (Internet Assigned Number Authority) website. For further information on these services, please read [Section 10.8 on page 170](#). Click the **Edit Customized Services** link while editing a firewall rule to configure a custom service port. This displays the following screen.

Refer to [Section 9.1 on page 144](#) for more information.

Figure 89 Firewall: Customized Services

No.	Name	Protocol	Port
1			
2			
3			
4			
5			
6			
7			
8			
9			
10			

Back

The following table describes the labels in this screen.

Table 59 Customized Services

LABEL	DESCRIPTION
No.	This is the number of your customized port. Click a rule's number of a service to go to a screen where you can configure or edit a customized service. See Section 10.6.3 on page 166 for more information.
Name	This is the name of your customized service.
Protocol	This shows the IP protocol (TCP , UDP or TCP/UDP) that defines your customized service.
Port	This is the port number or range that defines your customized service.
Back	Click Back to return the Firewall Edit Rule screen.

10.6.3 Configuring A Customized Service

Click a rule number in the **Firewall Customized Services** screen to create a new custom port or edit an existing one. This action displays the following screen.

Refer to [Section 9.1 on page 144](#) for more information.

Figure 90 Firewall: Configure Customized Services

The following table describes the labels in this screen.

Table 60 Firewall: Configure Customized Services

LABEL	DESCRIPTION
Service Name	Type a unique name for your custom port.
Service Type	Choose the IP port (TCP , UDP or TCP/UDP) that defines your customized port from the drop down list box.
Port Configuration	
Type	Click Single to specify one port only or Range to specify a span of ports that define your customized service.
Port Number	Type a single port number or the range of port numbers that define your customized service.
Apply	Click Apply to save your customized settings and exit this screen.
Cancel	Click Cancel to return to the previous screen.
Delete	Click Delete to delete the current rule and return to the previous screen.

10.7 Example Firewall Rule

The following Internet firewall rule example allows a hypothetical “MyService” connection from the Internet.

- 1 Click **Security > Firewall > Rules**.
- 2 Select **WAN to LAN** in the **Packet Direction** field.

Figure 91 Firewall Example: Rules

General **Rules** Anti Probing Threshold

Rules

Firewall Rules Storage Space in Use (3%)

0% 100%

Packet Direction WAN to LAN

Create a new rule after rule number : 0 Add

#	Active	Source IP	Destination IP	Service	Action	Schedule	Log	Modify	Order
.....									

Apply Cancel

- 3** In the **Rules** screen, select the index number after that you want to add the rule. For example, if you select “6”, your new rule becomes number 7 and the previous rule 7 (if there is one) becomes rule 8.
- 4** Click **Add** to display the firewall rule configuration screen.
- 5** In the **Edit Rule** screen, click the **Edit Customized Services** link to open the **Customized Service** screen.
- 6** Click an index number to display the **Customized Services Config** screen and configure the screen as follows and click **Apply**.

Figure 92 Edit Custom Port Example

Config

Service Name MyService

Service Type TCP/UDP

Port Configuration

Type Single Port Range

Port Number From 123 To 123

Apply Cancel Delete

- 7** Select **Any** in the **Destination Address** box and then click **Delete**.
- 8** Configure the destination address screen as follows and click **Add**.

Figure 93 Firewall Example: Edit Rule: Destination Address

The screenshot shows the 'Edit Rule 1' configuration window. At the top, there is a section for 'Active' status and 'Action for Matched Packets' set to 'Permit'. Below this is the 'Source Address' section, which includes an 'Address Type' dropdown set to 'Any Address', and input fields for 'Start IP Address' (0.0.0.0), 'End IP Address' (0.0.0.0), and 'Subnet Mask' (0.0.0.0). To the right of these fields are 'Add >>', 'Edit <<', and 'Delete' buttons. A 'Source Address List' box contains the entry 'Any'. The 'Destination Address' section is highlighted in blue and includes an 'Address Type' dropdown set to 'Range Address', and input fields for 'Start IP Address' (10.0.0.10), 'End IP Address' (10.0.0.15), and 'Subnet Mask' (0.0.0.0). It also has 'Add >>', 'Edit <<', and 'Delete' buttons. A 'Destination Address List' box contains the entry '10.0.0.10 - 10.0.0.15'. At the bottom, there is a 'Service' section which is currently empty.

- 9** Use the **Add >>** and **Remove** buttons between **Available Services** and **Selected Services** list boxes to configure it as follows. Click **Apply** when you are done.

Note: Custom services show up with an "*" before their names in the **Services** list box and the **Rules** list box.

Figure 94 Firewall Example: Edit Rule: Select Customized Services

Edit Rule 2

Active
Action for Matched Packets: **Permit**

Source Address

Address Type: **Any Address**
 Start IP Address: **0.0.0.0**
 End IP Address: **0.0.0.0**
 Subnet Mask: **0.0.0.0**

Source Address List: **Any**

Buttons: Add >>, Edit <<, Delete

Destination Address

Address Type: **Range Address**
 Start IP Address: **10.0.0.10**
 End IP Address: **10.0.0.15**
 Subnet Mask: **0.0.0.0**

Destination Address List: **10.0.0.10 - 10.0.0.15**

Buttons: Add >>, Edit <<, Delete

Service

Available Services:
 Any(All)
 Any(ICMP)
 AIMNEW-ICQ(TCP:5190)
 AUTH(TCP:113)
 BGP(TCP:179)

Selected Services:
 *MyService(TCP/UDP:123)

Buttons: Add >>, Remove

[Edit Customized Services](#)

Schedule

Day to Apply:
 Everyday
 Sun Mon Tue Wed Thu Fri Sat

Time of Day to Apply : (24-Hour Format)
 All day
 Start hour minute End hour minute

Log:
 Log Packet Detail Information.

Alert:
 Send Alert Message to Administrator When Matched.

Buttons: **Apply**, Cancel

On completing the configuration procedure for this Internet firewall rule, the **Rules** screen should look like the following.

Rule 1 allows a “MyService” connection from the WAN to IP addresses 10.0.0.10 through 10.0.0.15 on the LAN.

Figure 95 Firewall Example: Rules: MyService

Firewall Rules Storage Space in Use (3%)

0% 100%

Packet Direction: WAN to LAN

Create a new rule after rule number : 1

#	Active	Source IP	Destination IP	Service	Action	Schedule	Log	Modify	Order
1	<input checked="" type="checkbox"/>	Any	10.0.0.10 - 10.0.0.15	*MyService(TCP/UDP:123)	Permit	No	No		⤴ ⤵

10.8 Predefined Services

The **Available Services** list box in the **Edit Rule** screen (see [Section 10.6.1 on page 162](#)) displays all predefined services that the ZyXEL Device already supports. Next to the name of the service, two fields appear in brackets. The first field indicates the IP protocol type (TCP, UDP, or ICMP). The second field indicates the IP port number that defines the service. (Note that there may be more than one IP protocol type. For example, look at the default configuration labeled “(DNS)”. **(UDP/TCP:53)** means UDP port 53 and TCP port 53. Up to 128 entries are supported. Custom service ports may also be configured using the **Edit Customized Services** function discussed previously.

Table 61 Predefined Services

SERVICE	DESCRIPTION
AIM/NEW_ICQ(TCP:5190)	AOL's Internet Messenger service, used as a listening port by ICQ.
AUTH(TCP:113)	Authentication protocol used by some servers.
BGP(TCP:179)	Border Gateway Protocol.
BOOTP_CLIENT(UDP:68)	DHCP Client.
BOOTP_SERVER(UDP:67)	DHCP Server.
CU-SEEME(TCP/UDP:7648, 24032)	A popular videoconferencing solution from White Pines Software.
DNS(UDP/TCP:53)	Domain Name Server, a service that matches web names (e.g. www.zyxel.com) to IP numbers.
FINGER(TCP:79)	Finger is a UNIX or Internet related command that can be used to find out if a user is logged on.
FTP(TCP:20.21)	File Transfer Program, a program to enable fast transfer of files, including large files that may not be possible by e-mail.

Table 61 Predefined Services (continued)

SERVICE	DESCRIPTION
H.323(TCP:1720)	Net Meeting uses this protocol.
HTTP(TCP:80)	Hyper Text Transfer Protocol - a client/server protocol for the world wide web.
HTTPS	HTTPS is a secured http session often used in e-commerce.
ICQ(UDP:4000)	This is a popular Internet chat program.
IPSEC_TRANSPORT/ TUNNEL(AH:0)	The IPSEC AH (Authentication Header) tunneling protocol uses this service.
IPSEC_TUNNEL(ESP:0)	The IPSEC ESP (Encapsulation Security Protocol) tunneling protocol uses this service.
IRC(TCP/UDP:6667)	This is another popular Internet chat program.
MSN Messenger(TCP:1863)	Microsoft Networks' messenger service uses this protocol.
MULTICAST(IGMP:0)	Internet Group Multicast Protocol is used when sending packets to a specific group of hosts.
NEWS(TCP:144)	A protocol for news groups.
NFS(UDP:2049)	Network File System - NFS is a client/server distributed file service that provides transparent file-sharing for network environments.
NNTP(TCP:119)	Network News Transport Protocol is the delivery mechanism for the USENET newsgroup service.
PING(ICMP:0)	Packet INternet Groper is a protocol that sends out ICMP echo requests to test whether or not a remote host is reachable.
POP3(TCP:110)	Post Office Protocol version 3 lets a client computer get e-mail from a POP3 server through a temporary connection (TCP/IP or other).
PPTP(TCP:1723)	Point-to-Point Tunneling Protocol enables secure transfer of data over public networks. This is the control channel.
PPTP_TUNNEL(GRE:0)	Point-to-Point Tunneling Protocol enables secure transfer of data over public networks. This is the data channel.
RCMD(TCP:512)	Remote Command Service.
REAL_AUDIO(TCP:7070)	A streaming audio service that enables real time sound over the web.
REXEC(TCP:514)	Remote Execution Daemon.
RLOGIN(TCP:513)	Remote Login.
RTELNET(TCP:107)	Remote Telnet.
RTSP(TCP/UDP:554)	The Real Time Streaming (media control) Protocol (RTSP) is a remote control for multimedia on the Internet.
SFTP(TCP:115)	Simple File Transfer Protocol.
SMTP(TCP:25)	Simple Mail Transfer Protocol is the message-exchange standard for the Internet. SMTP enables you to move messages from one e-mail server to another.
SNMP(TCP/UDP:161)	Simple Network Management Program.
SNMP-TRAPS (TCP/ UDP:162)	Traps for use with the SNMP (RFC:1215).
SQL-NET(TCP:1521)	Structured Query Language is an interface to access data on many different types of database systems, including mainframes, midrange systems, UNIX systems and network servers.

Table 61 Predefined Services (continued)

SERVICE	DESCRIPTION
SSDP(UDP:1900)	Simple Service Discovery Protocol (SSDP) is a discovery service searching for Universal Plug and Play devices on your home network or upstream Internet gateways using DUDP port 1900.
SSH(TCP/UDP:22)	Secure Shell Remote Login Program.
STRMWORKS(UDP:1558)	Stream Works Protocol.
SYSLOG(UDP:514)	Syslog allows you to send system logs to a UNIX server.
TACACS(UDP:49)	Login Host Protocol used for (Terminal Access Controller Access Control System).
TELNET(TCP:23)	Telnet is the login and terminal emulation protocol common on the Internet and in UNIX environments. It operates over TCP/IP networks. Its primary function is to allow users to log into remote host systems.
TFTP(UDP:69)	Trivial File Transfer Protocol is an Internet file transfer protocol similar to FTP, but uses the UDP (User Datagram Protocol) rather than TCP (Transmission Control Protocol).
VDOLIVE(TCP:7000)	Another videoconferencing solution.

10.9 Anti-Probing

If an outside user attempts to probe an unsupported port on your ZyXEL Device, an ICMP response packet is automatically returned. This allows the outside user to know the ZyXEL Device exists. The ZyXEL Device supports anti-probing, which prevents the ICMP response packet from being sent. This keeps outsiders from discovering your ZyXEL Device when unsupported ports are probed.

Internet Control Message Protocol (ICMP) is a message control and error-reporting protocol between a host server and a gateway to the Internet. ICMP uses Internet Protocol (IP) datagrams, but the messages are processed by the TCP/IP software and directly apparent to the application user.

Refer to [Section 9.1 on page 144](#) for more information.

Click **Security > Firewall > Anti Probing** to display the screen as shown.

Figure 96 Firewall: Anti Probing

The following table describes the labels in this screen.

Table 62 Firewall: Anti Probing

LABEL	DESCRIPTION
Respond to PING on	The ZyXEL Device does not respond to any incoming Ping requests when Disable is selected. Select LAN to reply to incoming LAN Ping requests. Select WAN to reply to incoming WAN Ping requests. Otherwise select LAN & WAN to reply to both incoming LAN and WAN Ping requests.
Do Not Respond to Requests for Unauthorized Services.	Select this option to prevent hackers from finding the ZyXEL Device by probing for unused ports. If you select this option, the ZyXEL Device will not respond to port request(s) for unused ports, thus leaving the unused ports and the ZyXEL Device unseen. By default this option is not selected and the ZyXEL Device will reply with an ICMP Port Unreachable packet for a port probe on its unused UDP ports, and a TCP Reset packet for a port probe on its unused TCP ports. Note that the probing packets must first traverse the ZyXEL Device's firewall mechanism before reaching this anti-probing mechanism. Therefore if the firewall mechanism blocks a probing packet, the ZyXEL Device reacts based on the corresponding firewall policy to send a TCP reset packet for a blocked TCP packet or an ICMP port-unreachable packet for a blocked UDP packets or just drop the packets without sending a response packet.
Apply	Click Apply to save your changes back to the ZyXEL Device.
Cancel	Click Cancel to begin configuring this screen afresh.

10.10 DoS Thresholds

For DoS attacks, the ZyXEL Device uses thresholds to determine when to drop sessions that do not become fully established. These thresholds apply globally to all sessions.

You can use the default threshold values, or you can change them to values more suitable to your security requirements.

Refer to [Section 10.10.3 on page 175](#) to configure thresholds.

10.10.1 Threshold Values

Tune these parameters when something is not working and after you have checked the firewall counters. These default values should work fine for most small offices. Factors influencing choices for threshold values are:

- The maximum number of opened sessions.
- The minimum capacity of server backlog in your LAN network.
- The CPU power of servers in your LAN network.
- Network bandwidth.
- Type of traffic for certain servers.

If your network is slower than average for any of these factors (especially if you have servers that are slow or handle many tasks and are often busy), then the default values should be reduced.

You should make any changes to the threshold values before you continue configuring firewall rules.

10.10.2 Half-Open Sessions

An unusually high number of half-open sessions (either an absolute number or measured as the arrival rate) could indicate that a Denial of Service attack is occurring. For TCP, "half-open" means that the session has not reached the established state—the TCP three-way handshake has not yet been completed (see [Figure 82 on page 147](#)). For UDP, "half-open" means that the firewall has detected no return traffic.

The ZyXEL Device measures both the total number of existing half-open sessions and the rate of session establishment attempts. Both TCP and UDP half-open sessions are counted in the total number and rate measurements. Measurements are made once a minute.

When the number of existing half-open sessions rises above a threshold (**max-incomplete high**), the ZyXEL Device starts deleting half-open sessions as required to accommodate new connection requests. The ZyXEL Device continues to delete half-open requests as necessary, until the number of existing half-open sessions drops below another threshold (**max-incomplete low**).

When the rate of new connection attempts rises above a threshold (**one-minute high**), the ZyXEL Device starts deleting half-open sessions as required to accommodate new connection requests. The ZyXEL Device continues to delete half-open sessions as necessary, until the rate of new connection attempts drops below another threshold (**one-minute low**). The rate is the number of new attempts detected in the last one-minute sample period.

10.10.2.1 TCP Maximum Incomplete and Blocking Time

An unusually high number of half-open sessions with the same destination host address could indicate that a Denial of Service attack is being launched against the host.

Whenever the number of half-open sessions with the same destination host address rises above a threshold (**TCP Maximum Incomplete**), the ZyXEL Device starts deleting half-open sessions according to one of the following methods:

- If the **Blocking Time** timeout is 0 (the default), then the ZyXEL Device deletes the oldest existing half-open session for the host for every new connection request to the host. This ensures that the number of half-open sessions to a given host will never exceed the threshold.
- If the **Blocking Time** timeout is greater than 0, then the ZyXEL Device blocks all new connection requests to the host giving the server time to handle the present connections. The ZyXEL Device continues to block all new connection requests until the **Blocking Time** expires.

10.10.3 Configuring Firewall Thresholds

The ZyXEL Device also sends alerts whenever **TCP Maximum Incomplete** is exceeded. The global values specified for the threshold and timeout apply to all TCP connections.

Click **Firewall**, and **Threshold** to bring up the next screen.

Figure 97 Firewall: Threshold

The following table describes the labels in this screen.

Table 63 Firewall: Threshold

LABEL	DESCRIPTION	DEFAULT VALUES
Denial of Service Thresholds		
One Minute Low	This is the rate of new half-open sessions that causes the firewall to stop deleting half-open sessions. The ZyXEL Device continues to delete half-open sessions as necessary, until the rate of new connection attempts drops below this number.	80 existing half-open sessions.
One Minute High	This is the rate of new half-open sessions that causes the firewall to start deleting half-open sessions. When the rate of new connection attempts rises above this number, the ZyXEL Device deletes half-open sessions as required to accommodate new connection attempts.	100 half-open sessions per minute. The above numbers cause the ZyXEL Device to start deleting half-open sessions when more than 100 session establishment attempts have been detected in the last minute, and to stop deleting half-open sessions when fewer than 80 session establishment attempts have been detected in the last minute.

Table 63 Firewall: Threshold (continued)

LABEL	DESCRIPTION	DEFAULT VALUES
Maximum Incomplete Low	This is the number of existing half-open sessions that causes the firewall to stop deleting half-open sessions. The ZyXEL Device continues to delete half-open requests as necessary, until the number of existing half-open sessions drops below this number.	80 existing half-open sessions.
Maximum Incomplete High	This is the number of existing half-open sessions that causes the firewall to start deleting half-open sessions. When the number of existing half-open sessions rises above this number, the ZyXEL Device deletes half-open sessions as required to accommodate new connection requests. Do not set Maximum Incomplete High to lower than the current Maximum Incomplete Low number.	100 existing half-open sessions. The above values causes the ZyXEL Device to start deleting half-open sessions when the number of existing half-open sessions rises above 100, and to stop deleting half-open sessions with the number of existing half-open sessions drops below 80.
TCP Maximum Incomplete	This is the number of existing half-open TCP sessions with the same destination host IP address that causes the firewall to start dropping half-open sessions to that same destination host IP address. Enter a number between 1 and 256. As a general rule, you should choose a smaller number for a smaller network, a slower system or limited bandwidth.	30 existing half-open TCP sessions.
Action taken when the TCP Maximum Incomplete threshold is reached.		
Delete the oldest half open session when new connection request comes	Select this radio button to clear the oldest half open session when a new connection request comes.	
Deny new connection request for	Select this radio button and specify for how long the ZyXEL Device should block new connection requests when TCP Maximum Incomplete is reached. Enter the length of blocking time in minutes (between 1 and 256).	
Apply	Click Apply to save your changes back to the ZyXEL Device.	
Cancel	Click Cancel to begin configuring this screen afresh.	

CHAPTER 11

Content Filtering

This chapter covers how to configure content filtering.

11.1 Content Filtering Overview

Internet content filtering allows you to create and enforce Internet access policies tailored to your needs. Content filtering gives you the ability to block web sites that contain key words (that you specify) in the URL. You can set a schedule for when the ZyXEL Device performs content filtering. You can also specify trusted IP addresses on the LAN for which the ZyXEL Device will not perform content filtering.

11.2 Configuring Keyword Blocking

Use this screen to block sites containing certain keywords in the URL. For example, if you enable the keyword "bad", the ZyXEL Device blocks all sites containing this keyword including the URL `http://www.website.com/bad.html`, even if it is not included in the Filter List.

To have your ZyXEL Device block Web sites containing keywords in their URLs, click **Security > Content Filter**. The screen appears as shown.

Figure 98 Content Filter: Keyword

The screenshot shows a web-based configuration interface for content filtering. It features three tabs: 'Keyword', 'Schedule', and 'Trusted'. The 'Keyword' tab is active. The main area is titled 'Keyword' and contains a checked checkbox for 'Active Keyword Blocking'. Below this, the text reads 'Block Websites that contain these keywords in the URL :'. A text input field contains the keyword 'bad'. There are 'Delete' and 'Clear All' buttons below the input field. At the bottom of the main area, there is a 'Keyword' input field and an 'Add Keyword' button. At the very bottom of the window, there are 'Apply' and 'Cancel' buttons.

The following table describes the labels in this screen.

Table 64 Content Filter: Keyword

LABEL	DESCRIPTION
Active Keyword Blocking	Select this check box to enable this feature.
Block Websites that contain these keywords in the URL:	This box contains the list of all the keywords that you have configured the ZyXEL Device to block.
Delete	Highlight a keyword in the box and click Delete to remove it.
Clear All	Click Clear All to remove all of the keywords from the list.
Keyword	Type a keyword in this field. You may use any character (up to 127 characters). Wildcards are not allowed.
Add Keyword	Click Add Keyword after you have typed a keyword. Repeat this procedure to add other keywords. Up to 64 keywords are allowed. When you try to access a web page containing a keyword, you will get a message telling you that the content filter is blocking this request.
Apply	Click Apply to save your changes back to the ZyXEL Device.
Cancel	Click Cancel to return to the previously saved settings.

11.3 Configuring the Schedule

To set the days and times for the ZyXEL Device to perform content filtering, click **Security > Content Filter > Schedule**. The screen appears as shown.

Figure 99 Content Filter: Schedule

Day	Active	Start Time	End Time
Monday	<input checked="" type="checkbox"/>	8 hr 0 min	17 hr 30 min
Tuesday	<input checked="" type="checkbox"/>	0 hr 0 min	0 hr 0 min
Wednesday	<input checked="" type="checkbox"/>	0 hr 0 min	0 hr 0 min
Thursday	<input checked="" type="checkbox"/>	0 hr 0 min	0 hr 0 min
Friday	<input type="checkbox"/>	0 hr 0 min	0 hr 0 min
Saturday	<input type="checkbox"/>	0 hr 0 min	0 hr 0 min
Sunday	<input type="checkbox"/>	0 hr 0 min	0 hr 0 min

The following table describes the labels in this screen.

Table 65 Content Filter: Schedule

LABEL	DESCRIPTION
Schedule	Select Active Everyday to Block to make the content filtering active everyday. Otherwise, select Edit Daily to Block and configure which days of the week (or everyday) and which time of the day you want the content filtering to be active.
Active	Select the check box to have the content filtering to be active on the selected day.
Start Time	Enter the start time when you want the content filtering to take effect in hour-minute format.
End Time	Enter the end time when you want the content filtering to stop in hour-minute format.
Apply	Click Apply to save your changes.
Cancel	Click Cancel to return to the previously saved settings.

11.4 Configuring Trusted Computers

To exclude a range of users on the LAN from content filtering on your ZyXEL Device, click **Security > Content Filter > Trusted**. The screen appears as shown.

Figure 100 Content Filter: Trusted

The following table describes the labels in this screen.

Table 66 Content Filter: Trusted

LABEL	DESCRIPTION
Trusted User IP Range	
From	Type the IP address of a computer (or the beginning IP address of a specific range of computers) on the LAN that you want to exclude from content filtering.
To	Type the ending IP address of a specific range of users on your LAN that you want to exclude from content filtering. Leave this field blank if you want to exclude an individual computer.
Apply	Click Apply to save your changes back to the ZyXEL Device.
Cancel	Click Cancel to return to the previously saved settings.

CHAPTER 12

Static Route

This chapter shows you how to configure static routes for your ZyXEL Device.

12.1 Static Route

Each remote node specifies only the network to which the gateway is directly connected, and the ZyXEL Device has no knowledge of the networks beyond. For instance, the ZyXEL Device knows about network N2 in the following figure through remote node Router 1. However, the ZyXEL Device is unable to route a packet to network N3 because it doesn't know that there is a route through the same remote node Router 1 (via gateway Router 2). The static routes are for you to tell the ZyXEL Device about the networks beyond the remote nodes.

Figure 101 Example of Static Routing Topology

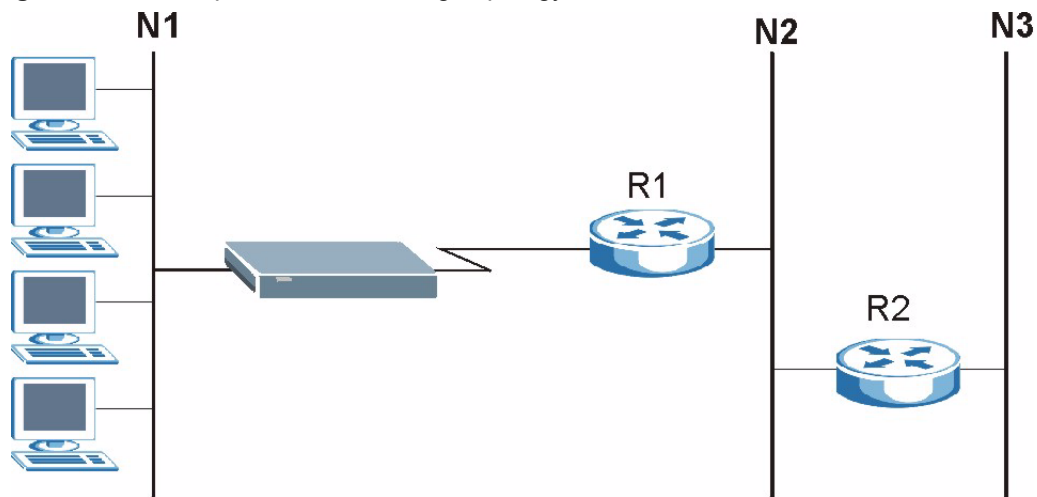

12.2 Configuring Static Route

Click **Advanced** > **Static Route** to open the **Static Route** screen.

Figure 102 Static Route

#	Active	Name	Destination	Gateway	Subnet Mask	Modify
1	<input checked="" type="checkbox"/>	test	10.10.1.2	192.168.1.3	255.0.0.0	
2	<input type="checkbox"/>	-	-	-	-	
3	<input type="checkbox"/>	-	-	-	-	
4	<input type="checkbox"/>	-	-	-	-	
5	<input type="checkbox"/>	-	-	-	-	
6	<input type="checkbox"/>	-	-	-	-	
7	<input type="checkbox"/>	-	-	-	-	
8	<input type="checkbox"/>	-	-	-	-	
9	<input type="checkbox"/>	-	-	-	-	
10	<input type="checkbox"/>	-	-	-	-	
11	<input type="checkbox"/>	-	-	-	-	
12	<input type="checkbox"/>	-	-	-	-	
13	<input type="checkbox"/>	-	-	-	-	
14	<input type="checkbox"/>	-	-	-	-	
15	<input type="checkbox"/>	-	-	-	-	
16	<input type="checkbox"/>	-	-	-	-	

The following table describes the labels in this screen.

Table 67 Static Route

LABEL	DESCRIPTION
#	This is the number of an individual static route.
Active	Select the check box to activate this static route. Otherwise, clear the check box.
Name	This is the name that describes or identifies this route.
Destination	This parameter specifies the IP network address of the final destination. Routing is always based on network number.
Gateway	This is the IP address of the gateway. The gateway is a router or switch on the same network segment as the device's LAN or WAN port. The gateway helps forward packets to their destinations.
Subnet Mask	This is the IP subnet mask.
Modify	Click the Edit icon to go to the screen where you can set up a static route on the ZyXEL Device. Click the Delete icon to remove a static route from the ZyXEL Device. A window displays asking you to confirm that you want to delete the route.

12.2.1 Static Route Edit

Select a static route index number and click **Edit**. The screen shown next appears. Use this screen to configure the required information for a static route.

Figure 103 Static Route Edit

The following table describes the labels in this screen.

Table 68 Static Route Edit

LABEL	DESCRIPTION
Active	This field allows you to activate/deactivate this static route.
Route Name	Enter the name of the IP static route. Leave this field blank to delete this static route.
Destination IP Address	This parameter specifies the IP network address of the final destination. Routing is always based on network number. If you need to specify a route to a single host, use a subnet mask of 255.255.255.255 in the subnet mask field to force the network number to be identical to the host ID.
IP Subnet Mask	Enter the IP subnet mask here.
Gateway IP Address	Enter the IP address of the gateway. The gateway is a router or switch on the same network segment as the device's LAN or WAN port. The gateway helps forward packets to their destinations.
Back	Click Back to return to the previous screen without saving.
Apply	Click Apply to save your changes back to the ZyXEL Device.
Cancel	Click Cancel to begin configuring this screen afresh.

CHAPTER 13

Bandwidth Management

This chapter contains information about configuring bandwidth management, editing rules and viewing the ZyXEL Device's bandwidth management logs.

13.1 Bandwidth Management Overview

ZyXEL's Bandwidth Management allows you to specify bandwidth management rules based on an application and/or subnet. You can allocate specific amounts of bandwidth capacity (bandwidth budgets) to different bandwidth rules.

The ZyXEL Device applies bandwidth management to traffic that it forwards out through an interface. The ZyXEL Device does not control the bandwidth of traffic that comes into an interface.

Bandwidth management applies to all traffic flowing out of the router, regardless of the traffic's source.

Traffic redirect or IP alias may cause LAN-to-LAN traffic to pass through the ZyXEL Device and be managed by bandwidth management.

The sum of the bandwidth allotments that apply to any interface must be less than or equal to the speed allocated to that interface in the **Bandwidth Management > Summary** screen.

13.2 Application-based Bandwidth Management

You can create bandwidth classes based on individual applications (like VoIP, Web, FTP, E-mail and Video for example).

13.3 Subnet-based Bandwidth Management

You can create bandwidth classes based on subnets.

The following figure shows LAN subnets. You could configure one bandwidth class for subnet **A** and another for subnet **B**.

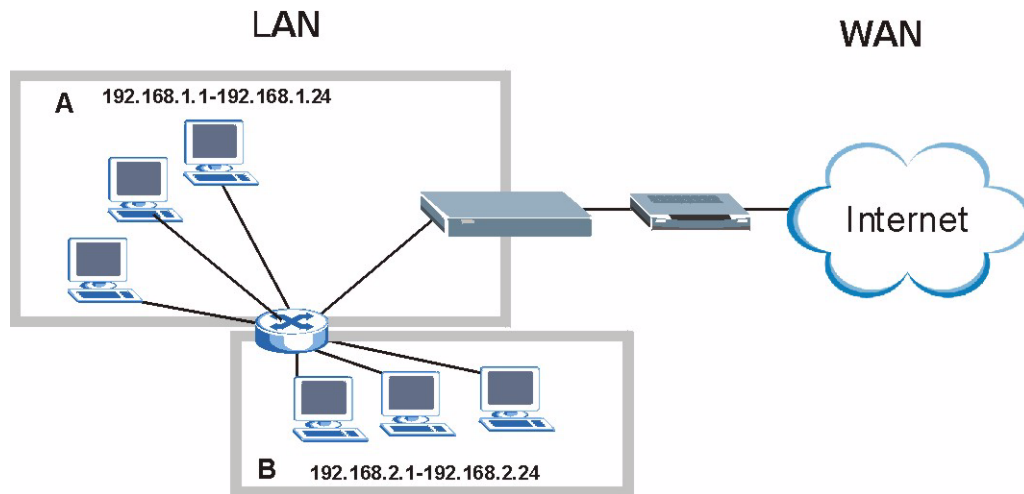
Figure 104 Subnet-based Bandwidth Management Example

13.4 Application and Subnet-based Bandwidth Management

You could also create bandwidth classes based on a combination of a subnet and an application. The following example table shows bandwidth allocations for application specific traffic from separate LAN subnets.

Table 69 Application and Subnet-based Bandwidth Management Example

TRAFFIC TYPE	FROM SUBNET A	FROM SUBNET B
VoIP	64 Kbps	64 Kbps
Web	64 Kbps	64 Kbps
FTP	64 Kbps	64 Kbps
E-mail	64 Kbps	64 Kbps
Video	64 Kbps	64 Kbps

13.5 Scheduler

The scheduler divides up an interface's bandwidth among the bandwidth classes. The ZyXEL Device has two types of scheduler: fairness-based and priority-based.

13.5.1 Priority-based Scheduler

With the priority-based scheduler, the ZyXEL Device forwards traffic from bandwidth classes according to the priorities that you assign to the bandwidth classes. The larger a bandwidth class's priority number is, the higher the priority. Assign real-time applications (like those using audio or video) a higher priority number to provide smoother operation.

13.5.2 Fairness-based Scheduler

The ZyXEL Device divides bandwidth equally among bandwidth classes when using the fairness-based scheduler; thus preventing one bandwidth class from using all of the interface's bandwidth.

13.6 Maximize Bandwidth Usage

The maximize bandwidth usage option (see [Figure 105 on page 191](#)) allows the ZyXEL Device to divide up any available bandwidth on the interface (including unallocated bandwidth and any allocated bandwidth that a class is not using) among the bandwidth classes that require more bandwidth.

When you enable maximize bandwidth usage, the ZyXEL Device first makes sure that each bandwidth class gets up to its bandwidth allotment. Next, the ZyXEL Device divides up an interface's available bandwidth (bandwidth that is unbudgeted or unused by the classes) depending on how many bandwidth classes require more bandwidth and on their priority levels. When only one class requires more bandwidth, the ZyXEL Device gives extra bandwidth to that class.

When multiple classes require more bandwidth, the ZyXEL Device gives the highest priority classes the available bandwidth first (as much as they require, if there is enough available bandwidth), and then to lower priority classes if there is still bandwidth available. The ZyXEL Device distributes the available bandwidth equally among classes with the same priority level.

13.6.1 Reserving Bandwidth for Non-Bandwidth Class Traffic

Do the following three steps to configure the ZyXEL Device to allow bandwidth for traffic that is not defined in a bandwidth filter.

- 1 Leave some of the interface's bandwidth unbudgeted.
- 2 Do not enable the interface's **Maximize Bandwidth Usage** option.
- 3 Do not enable bandwidth borrowing on the child-classes that have the root class as their parent (see [Section 13.9 on page 192](#)).

13.6.2 Maximize Bandwidth Usage Example

Here is an example of a ZyXEL Device that has maximize bandwidth usage enabled on an interface. The following table shows each bandwidth class's bandwidth budget. The classes are set up based on subnets. The interface is set to 10240 kbps. Each subnet is allocated 2048 kbps. The unbudgeted 2048 kbps allows traffic not defined in any of the bandwidth filters to go out when you do not select the maximize bandwidth option.

Table 70 Maximize Bandwidth Usage Example

BANDWIDTH CLASSES AND ALLOTMENTS	
Root Class: 10240 kbps	Administration: 2048 kbps
	Sales: 2048 kbps
	Marketing: 2048 kbps
	Research: 2048 kbps

The ZyXEL Device divides up the unbudgeted 2048 kbps among the classes that require more bandwidth. If the administration department only uses 1024 kbps of the budgeted 2048 kbps, the ZyXEL Device also divides the remaining 1024 kbps among the classes that require more bandwidth. Therefore, the ZyXEL Device divides a total of 3072 kbps of unbudgeted and unused bandwidth among the classes that require more bandwidth.

13.6.2.1 Priority-based Allotment of Unused and Unbudgeted Bandwidth

The following table shows the priorities of the bandwidth classes and the amount of bandwidth that each class gets.

Table 71 Priority-based Allotment of Unused and Unbudgeted Bandwidth Example

BANDWIDTH CLASSES, PRIORITIES AND ALLOTMENTS	
Root Class: 10240 kbps	Administration: Priority 4, 1024 kbps
	Sales: Priority 6, 3584 kbps
	Marketing: Priority 6, 3584 kbps
	Research: Priority 5, 2048 kbps

Suppose that all of the classes except for the administration class need more bandwidth.

- Each class gets up to its budgeted bandwidth. The administration class only uses 1024 kbps of its budgeted 2048 kbps.
- The sales and marketing are first to get extra bandwidth because they have the highest priority (6). If they each require 1536 kbps or more of extra bandwidth, the ZyXEL Device divides the total 3072 kbps total of unbudgeted and unused bandwidth equally between the sales and marketing departments (1536 kbps extra to each for a total of 3584 kbps for each) because they both have the highest priority level.

- Research requires more bandwidth but only gets its budgeted 2048 kbps because all of the unbudgeted and unused bandwidth goes to the higher priority sales and marketing classes.

13.6.2.2 Fairness-based Allotment of Unused and Unbudgeted Bandwidth

The following table shows the amount of bandwidth that each class gets.

Table 72 Fairness-based Allotment of Unused and Unbudgeted Bandwidth Example

BANDWIDTH CLASSES AND ALLOTMENTS	
Root Class: 10240 kbps	Administration: 1024 kbps
	Sales: 3072 kbps
	Marketing: 3072 kbps
	Research: 3072 kbps

Suppose that all of the classes except for the administration class need more bandwidth.

- Each class gets up to its budgeted bandwidth. The administration class only uses 1024 kbps of its budgeted 2048 kbps.
- The ZyXEL Device divides the total 3072 kbps total of unbudgeted and unused bandwidth equally among the other classes. 1024 kbps extra goes to each so the other classes each get a total of 3072 kbps.

13.6.3 Bandwidth Management Priorities

The following table describes the priorities that you can apply to traffic that the ZyXEL Device forwards out through an interface.

Table 73 Bandwidth Management Priorities

PRIORITY LEVELS: TRAFFIC WITH A HIGHER PRIORITY GETS THROUGH FASTER WHILE TRAFFIC WITH A LOWER PRIORITY IS DROPPED IF THE NETWORK IS CONGESTED.	
High	Typically used for voice traffic or video that is especially sensitive to jitter (jitter is the variations in delay).
Mid	Typically used for "excellent effort" or better than best effort and would include important business traffic that can tolerate some delay.
Low	This is typically used for non-critical "background" traffic such as bulk transfers that are allowed but that should not affect other applications and users.

13.7 Over Allotment of Bandwidth

You can set the bandwidth management speed for an interface higher than the interface's actual transmission speed. Higher priority traffic gets to use up to its allocated bandwidth, even if it takes up all of the interface's available bandwidth. This could stop lower priority traffic from being sent. The following is an example.

Table 74 Over Allotment of Bandwidth Example

BANDWIDTH CLASSES, ALLOTMENTS		PRIORITIES
Actual outgoing bandwidth available on the interface: 1000 kbps		
Root Class: 1500 kbps (same as Speed setting)	VoIP traffic (Service = SIP): 500 Kbps	High
	NetMeeting traffic (Service = H.323): 500 kbps	High
	FTP (Service = FTP): 500 Kbps	Medium

If you use VoIP and NetMeeting at the same time, the device allocates up to 500 Kbps of bandwidth to each of them before it allocates any bandwidth to FTP. As a result, FTP can only use bandwidth when VoIP and NetMeeting do not use all of their allocated bandwidth.

Suppose you try to browse the web too. In this case, VoIP, NetMeeting and FTP all have higher priority, so they get to use the bandwidth first. You can only browse the web when VoIP, NetMeeting, and FTP do not use all 1000 Kbps of available bandwidth.

13.8 Configuring Summary

Click **Advanced > Bandwidth MGMT** to open the screen as shown next.

Enable bandwidth management on an interface and set the maximum allowed bandwidth for that interface.

Figure 105 Bandwidth Management: Summary

The screenshot shows the 'Summary' tab of the Bandwidth Management configuration. It includes a summary table and control buttons.

Interface	Active	Speed(kbps)	Scheduler	Max Bandwidth Usage
LAN	<input checked="" type="checkbox"/>	100000	Priority-Based	<input checked="" type="checkbox"/> Yes
WLAN	<input checked="" type="checkbox"/>	54000	Priority-Based	<input checked="" type="checkbox"/> Yes
WAN	<input checked="" type="checkbox"/>	100000	Priority-Based	<input checked="" type="checkbox"/> Yes

Buttons: Apply, Reset

The following table describes the labels in this screen.

Table 75 Media Bandwidth Management: Summary

LABEL	DESCRIPTION
Interface	These read-only labels represent the physical interfaces. Select an interface's check box to enable bandwidth management on that interface. Bandwidth management applies to all traffic flowing out of the router through the interface, regardless of the traffic's source. Traffic redirect or IP alias may cause LAN-to-LAN traffic to pass through the ZyXEL Device and be managed by bandwidth management.
Active	Select an interface's check box to enable bandwidth management on that interface.
Speed (kbps)	Enter the amount of bandwidth for this interface that you want to allocate using bandwidth management. The recommendation is to set this speed to match the interface's actual transmission speed. For example, set the WAN interface speed to 1000 kbps if your Internet connection has an upstream transmission speed of 1 Mbps. You can set this number higher than the interface's actual transmission speed. This may stop lower priority traffic from being sent if higher priority traffic uses all of the actual bandwidth. You can also set this number lower than the interface's actual transmission speed. If you do not enable Max Bandwidth Usage , this will cause the ZyXEL Device to not use some of the interface's available bandwidth.
Scheduler	Select either Priority-Based or Fairness-Based from the drop-down menu to control the traffic flow. Select Priority-Based to give preference to bandwidth classes with higher priorities. Select Fairness-Based to treat all bandwidth classes equally.
Max Bandwidth Usage	Select this check box to have the ZyXEL Device divide up all of the interface's unallocated and/or unused bandwidth among the bandwidth classes that require bandwidth. Do not select this if you want to reserve bandwidth for traffic that does not match a bandwidth class or you want to limit the speed of this interface (see the Speed field description).
Apply	Click Apply to save your settings back to the ZyXEL Device.
Cancel	Click Cancel to begin configuring this screen afresh.

13.9 Bandwidth Management Rule Setup

You must use the **Bandwidth Management Summary** screen to enable bandwidth management on an interface before you can configure rules for that interface.

Click **Advanced > Bandwidth MGMT > Rule Setup** to open the following screen.

Figure 106 Bandwidth Management: Rule Setup

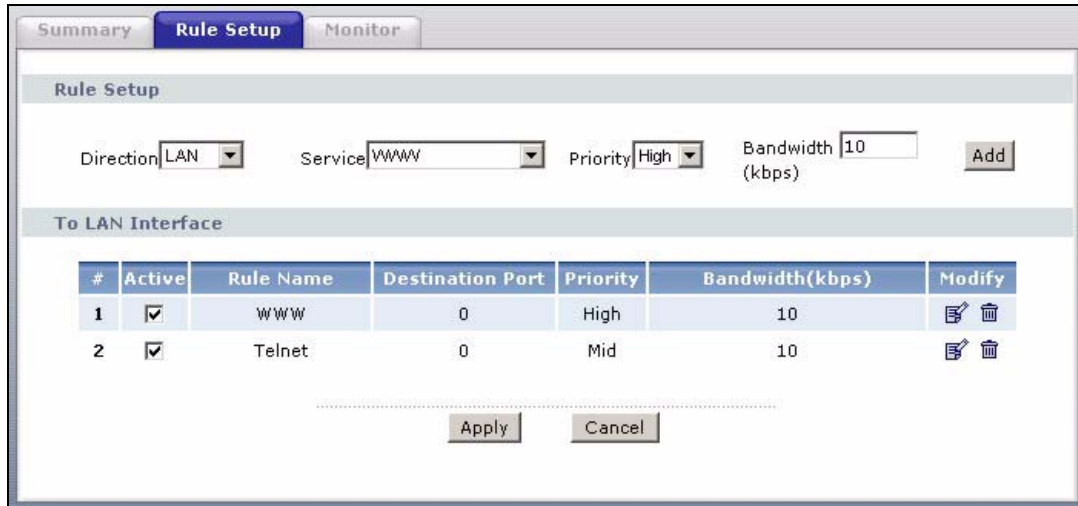

The following table describes the labels in this screen.

Table 76 Bandwidth Management: Rule Setup

LABEL	DESCRIPTION
Direction	Select the direction of traffic to which you want to apply bandwidth management.
Service	Select a service for your rule or you can select User Defined to go to the screen where you can define your own.
Priority	Select a priority from the drop down list box. Choose High , Mid or Low .
Bandwidth (kbps)	Specify the maximum bandwidth allowed for the rule in kbps. The recommendation is a setting between 20 kbps and 20000 kbps for an individual rule.
Add	Click this button to add a rule to the following table.
#	This is the number of an individual bandwidth management rule.
Active	This displays whether the rule is enabled. Select this check box to have the ZyXEL Device apply this bandwidth management rule. Enable a bandwidth management rule to give traffic that matches the rule priority over traffic that does not match the rule. Enabling a bandwidth management rule also allows you to control the maximum amounts of bandwidth that can be used by traffic that matches the rule.
Rule Name	This is the name of the rule.
Destination Port	This is the port number of the destination. 0 means any destination port.
Priority	This is the priority of this rule.
Bandwidth (kbps)	This is the maximum bandwidth allowed for the rule in kbps.
Modify	Click the Edit icon to go to the screen where you can edit the rule. Click the Remove icon to delete an existing rule.
Apply	Click Apply to save your changes back to the ZyXEL Device.
Cancel	Click Cancel to begin configuring this screen afresh.

13.9.1 Rule Configuration

Click the Edit icon or select **User Defined** from the **Service** drop-down list in the **Rule Setup** screen to configure a bandwidth management rule. Use bandwidth rules to allocate specific amounts of bandwidth capacity (bandwidth budgets) to specific applications and/or subnets.

Figure 107 Bandwidth Management Rule Configuration

The following table describes the labels in this screen.

Table 77 Bandwidth Management Rule Configuration

LABEL	DESCRIPTION
Rule Configuration	
Active	Select this check box to have the ZyXEL Device apply this bandwidth management rule. Enable a bandwidth management rule to give traffic that matches the rule priority over traffic that does not match the rule. Enabling a bandwidth management rule also allows you to control the maximum amounts of bandwidth that can be used by traffic that matches the rule.
Rule Name	Use the auto-generated name or enter a descriptive name of up to 20 alphanumeric characters, including spaces.
BW Budget	Specify the maximum bandwidth allowed for the rule in kbps. The recommendation is a setting between 20 kbps and 20000 kbps for an individual rule.
Priority	Select a priority from the drop down list box. Choose High , Mid or Low .

Table 77 Bandwidth Management Rule Configuration (continued)

LABEL	DESCRIPTION
Use All Managed Bandwidth	Select this option to allow a rule to borrow unused bandwidth on the interface. Bandwidth borrowing is governed by the priority of the rules. That is, a rule with the highest priority is the first to borrow bandwidth. Do not select this if you want to leave bandwidth available for other traffic types or if you want to restrict the amount of bandwidth that can be used for the traffic that matches this rule.
Filter Configuration	
Service	<p>This field simplifies bandwidth class configuration by allowing you to select a predefined application. When you select a predefined application, you do not configure the rest of the bandwidth filter fields (other than enabling or disabling the filter).</p> <p>SIP (Session Initiation Protocol) is a signaling protocol used in Internet telephony, instant messaging and other VoIP (Voice over IP) applications. Select SIP from the drop-down list box to configure this bandwidth filter for traffic that uses SIP.</p> <p>File Transfer Protocol (FTP) is an Internet file transfer service that operates on the Internet and over TCP/IP networks. A system running the FTP server accepts commands from a system running an FTP client. The service allows users to send commands to the server for uploading and downloading files. Select FTP from the drop-down list box to configure this bandwidth filter for FTP traffic.</p> <p>H.323 is a standard teleconferencing protocol suite that provides audio, data and video conferencing. It allows for real-time point-to-point and multipoint communication between client computers over a packet-based network that does not provide a guaranteed quality of service. Select H.323 from the drop-down list box to configure this bandwidth filter for traffic that uses H.323.</p> <p>Select User defined from the drop-down list box if you do not want to use a predefined application for the bandwidth class. When you select User defined, you need to configure at least one of the following fields (other than the Subnet Mask fields which you only enter if you also enter a corresponding destination or source IP address).</p>
Destination Address	Enter the destination IP address in dotted decimal notation.
Destination Subnet Netmask	Enter the destination subnet mask. This field is N/A if you do not specify a Destination Address . Refer to the appendices for more information on IP subnetting.
Destination Port	Enter the port number of the destination. See Table 78 on page 196 for some common services and port numbers. A blank destination IP address means any destination IP address.
Source Address	Enter the source IP address in dotted decimal notation. A blank source IP address means any source IP address.
Source Subnet Netmask	Enter the destination subnet mask. This field is N/A if you do not specify a Source Address . Refer to the appendices for more information on IP subnetting. A blank source port means any source port number.
Source Port	Enter the port number of the source. See Table 78 on page 196 for some common services and port numbers.
Protocol	Select the protocol (TCP or UDP) or select User defined and enter the protocol (service type) number. 0 means any protocol number.
Back	Click Back to go to the previous screen.
Apply	Click Apply to save your changes back to the ZyXEL Device.
Cancel	Click Cancel to begin configuring this screen afresh.

Table 78 Services and Port Numbers

SERVICES	PORT NUMBER
ECHO	7
FTP (File Transfer Protocol)	21
SMTP (Simple Mail Transfer Protocol)	25
DNS (Domain Name System)	53
Finger	79
HTTP (Hyper Text Transfer protocol or WWW, Web)	80
POP3 (Post Office Protocol)	110
NNTP (Network News Transport Protocol)	119
SNMP (Simple Network Management Protocol)	161
SNMP trap	162
PPTP (Point-to-Point Tunneling Protocol)	1723

13.10 Bandwidth Monitor

To view the ZyXEL Device's bandwidth usage and allotments, click **Advanced > Bandwidth MGMT > Monitor**. The screen appears as shown. Select an interface from the drop-down list box to view the bandwidth usage of its bandwidth rules. The gray section of the bar represents the percentage of unused bandwidth and the blue color represents the percentage of bandwidth in use.

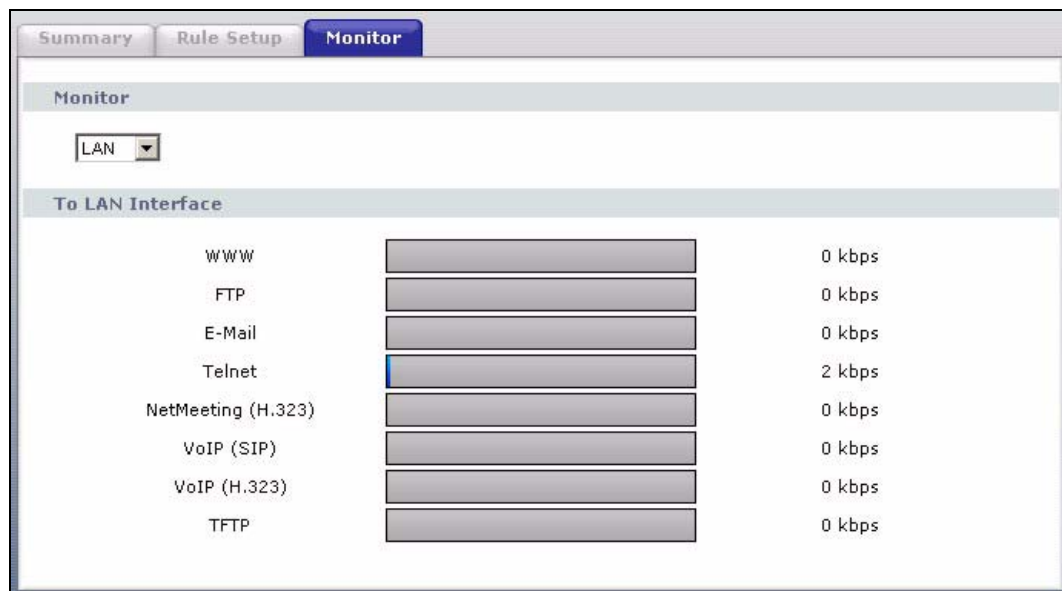
Figure 108 Bandwidth Management: Monitor

CHAPTER 14

Dynamic DNS Setup

This chapter discusses how to configure your ZyXEL Device to use Dynamic DNS.

14.1 Dynamic DNS Overview

Dynamic DNS allows you to update your current dynamic IP address with one or many dynamic DNS services so that anyone can contact you (in NetMeeting, CU-SeeMe, etc.). You can also access your FTP server or Web site on your own computer using a domain name (for instance myhost.dhs.org, where myhost is a name of your choice) that will never change instead of using an IP address that changes each time you reconnect. Your friends or relatives will always be able to call you even if they don't know your IP address.

First of all, you need to have registered a dynamic DNS account with www.dyndns.org. This is for people with a dynamic IP from their ISP or DHCP server that would still like to have a domain name. The Dynamic DNS service provider will give you a password or key.

14.1.1 DYNDNS Wildcard

Enabling the wildcard feature for your host causes *.yourhost.dyndns.org to be aliased to the same IP address as yourhost.dyndns.org. This feature is useful if you want to be able to use, for example, www.yourhost.dyndns.org and still reach your hostname.

If you have a private WAN IP address, then you cannot use Dynamic DNS.

See [Section 14.2 on page 198](#) for configuration instruction.

14.2 Configuring Dynamic DNS

To change your ZyXEL Device's DDNS, click **Advanced > Dynamic DNS**. The screen appears as shown.

See [Section 14.1 on page 198](#) for more information.

Figure 109 Dynamic DNS

The following table describes the fields in this screen.

Table 79 Dynamic DNS

LABEL	DESCRIPTION
Dynamic DNS Setup	
Active Dynamic DNS	Select this check box to use dynamic DNS.
Service Provider	This is the name of your Dynamic DNS service provider.
Dynamic DNS Type	Select the type of service that you are registered for from your Dynamic DNS service provider.
Host Name	Type the domain name assigned to your ZyXEL Device by your Dynamic DNS provider. You can specify up to two host names in the field separated by a comma (",").
User Name	Type your user name.
Password	Type the password assigned to you.
Enable Wildcard Option	Select the check box to enable DynDNS Wildcard.
Enable off line option	This option is available when Custom DNS is selected in the DDNS Type field. Check with your Dynamic DNS service provider to have traffic redirected to a URL (that you can specify) while you are off line.
IP Address Update Policy	
Use WAN IP Address	Select this option to update the IP address of the host name(s) to the WAN IP address.

Table 79 Dynamic DNS (continued)

LABEL	DESCRIPTION
Dynamic DNS server auto detect IP Address	Select this option only when there are one or more NAT routers between the ZyXEL Device and the DDNS server. This feature has the DDNS server automatically detect and use the IP address of the NAT router that has a public IP address. Note: The DDNS server may not be able to detect the proper IP address if there is an HTTP proxy server between the ZyXEL Device and the DDNS server.
Use specified IP Address	Type the IP address of the host name(s). Use this if you have a static IP address.
Apply	Click Apply to save your changes back to the ZyXEL Device.
Cancel	Click Cancel to begin configuring this screen afresh.

CHAPTER 15

Remote Management Configuration

This chapter provides information on configuring remote management.

15.1 Remote Management Overview

Remote management allows you to determine which services/protocols can access which ZyXEL Device interface (if any) from which computers.

Note: When you configure remote management to allow management from the WAN, you still need to configure a firewall rule to allow access.

You may manage your ZyXEL Device from a remote location via:

- Internet (WAN only)
- ALL (LAN and WAN)
- LAN only,
- Neither (Disable).

Note: When you choose **WAN** only or **LAN & WAN**, you still need to configure a firewall rule to allow access.

To disable remote management of a service, select **Disable** in the corresponding **Access Status** field.

You may only have one remote management session running at a time. The ZyXEL Device automatically disconnects a remote management session of lower priority when another remote management session of higher priority starts. The priorities for the different types of remote management sessions are as follows.

- 1 Telnet
- 2 HTTP

15.1.1 Remote Management Limitations

Remote management over LAN or WAN will not work when:

- You have disabled that service in one of the remote management screens.

- The IP address in the **Secured Client IP** field does not match the client IP address. If it does not match, the ZyXEL Device will disconnect the session immediately.
- There is already another remote management session with an equal or higher priority running. You may only have one remote management session running at one time.
- There is a firewall rule that blocks it.

15.1.2 Remote Management and NAT

When NAT is enabled:

- Use the ZyXEL Device's WAN IP address when configuring from the WAN.
- Use the ZyXEL Device's LAN IP address when configuring from the LAN.

15.1.3 System Timeout

There is a default system management idle timeout of five minutes (three hundred seconds). The ZyXEL Device automatically logs you out if the management session remains idle for longer than this timeout period. The management session does not time out when a statistics screen is polling.

15.2 WWW

To change your ZyXEL Device's World Wide Web settings, click **Advanced > Remote MGMT** to display the **WWW** screen.

Figure 110 Remote Management: WWW

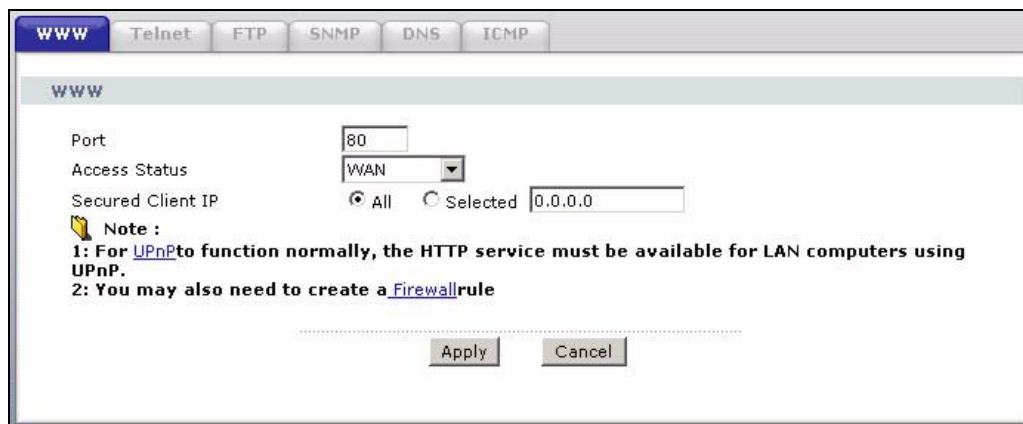

The screenshot shows the 'WWW' configuration page in a web interface. At the top, there are tabs for 'WWW', 'Telnet', 'FTP', 'SNMP', 'DNS', and 'ICMP'. The 'WWW' tab is selected. Below the tabs, the 'WWW' title is displayed. The configuration fields are as follows:

- Port:** A text input field containing the value '80'.
- Access Status:** A dropdown menu with 'WAN' selected.
- Secured Client IP:** Radio buttons for 'All' (selected) and 'Selected', followed by a text input field containing '0.0.0.0'.

Below the configuration fields, there is a **Note** section with a yellow warning icon:

Note :
1: For UPnP to function normally, the HTTP service must be available for LAN computers using UPnP.
2: You may also need to create a Firewall rule

At the bottom of the page, there are two buttons: 'Apply' and 'Cancel'.

The following table describes the labels in this screen.

Table 80 Remote Management: WWW

LABEL	DESCRIPTION
Port	You may change the server port number for a service if needed, however you must use the same port number in order to use that service for remote management.
Access Status	Select the interface(s) through which a computer may access the ZyXEL Device using this service.
Secured Client IP	A secured client is a "trusted" computer that is allowed to communicate with the ZyXEL Device using this service. Select All to allow any computer to access the ZyXEL Device using this service. Choose Selected to just allow the computer with the IP address that you specify to access the ZyXEL Device using this service.
Apply	Click Apply to save your settings back to the ZyXEL Device.
Cancel	Click Cancel to begin configuring this screen afresh.

15.3 Telnet

You can configure your ZyXEL Device for remote Telnet access as shown next. The administrator uses Telnet from a computer on a remote network to access the ZyXEL Device.

Figure 111 Telnet Configuration on a TCP/IP Network

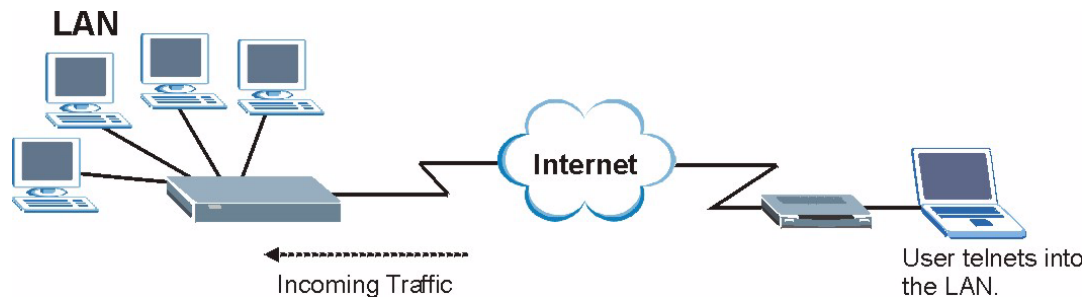

15.4 Configuring Telnet

Click **Advanced** > **Remote MGMT** > **Telnet** tab to display the screen as shown.

Figure 112 Remote Management: Telnet

The following table describes the labels in this screen.

Table 81 Remote Management: Telnet

LABEL	DESCRIPTION
Port	You may change the server port number for a service if needed, however you must use the same port number in order to use that service for remote management.
Access Status	Select the interface(s) through which a computer may access the ZyXEL Device using this service.
Secured Client IP	A secured client is a “trusted” computer that is allowed to communicate with the ZyXEL Device using this service. Select All to allow any computer to access the ZyXEL Device using this service. Choose Selected to just allow the computer with the IP address that you specify to access the ZyXEL Device using this service.
Apply	Click Apply to save your customized settings and exit this screen.
Cancel	Click Cancel to begin configuring this screen afresh.

15.5 Configuring FTP

You can upload and download the ZyXEL Device’s firmware and configuration files using FTP, please see the chapter on firmware and configuration file maintenance for details. To use this feature, your computer must have an FTP client.

To change your ZyXEL Device’s FTP settings, click **Advanced > Remote MGMT > FTP** tab. The screen appears as shown.

Figure 113 Remote Management: FTP

The following table describes the labels in this screen.

Table 82 Remote Management: FTP

LABEL	DESCRIPTION
Port	You may change the server port number for a service if needed, however you must use the same port number in order to use that service for remote management.
Access Status	Select the interface(s) through which a computer may access the ZyXEL Device using this service.
Secured Client IP	A secured client is a “trusted” computer that is allowed to communicate with the ZyXEL Device using this service. Select All to allow any computer to access the ZyXEL Device using this service. Choose Selected to just allow the computer with the IP address that you specify to access the ZyXEL Device using this service.
Apply	Click Apply to save your customized settings and exit this screen.
Cancel	Click Cancel to begin configuring this screen afresh.

15.6 SNMP

Simple Network Management Protocol (SNMP) is a protocol used for exchanging management information between network devices. SNMP is a member of the TCP/IP protocol suite. Your ZyXEL Device supports SNMP agent functionality, which allows a manager station to manage and monitor the ZyXEL Device through the network. The ZyXEL Device supports SNMP version one (SNMPv1) and version two (SNMPv2). The next figure illustrates an SNMP management operation.

Note: SNMP is only available if TCP/IP is configured.

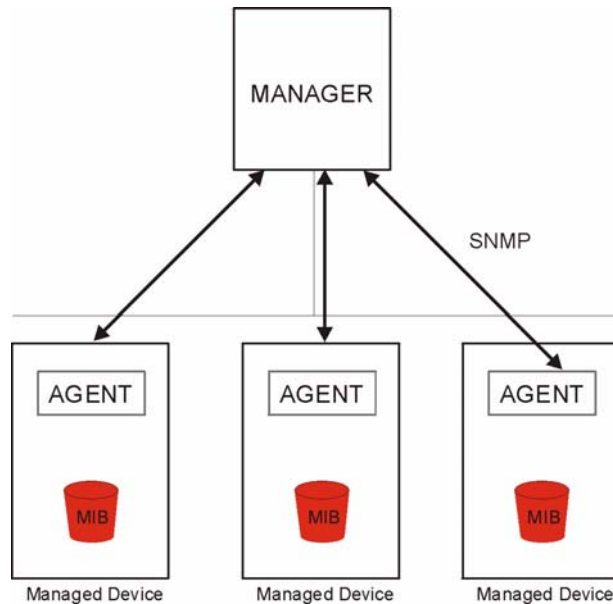
Figure 114 SNMP Management Model

An SNMP managed network consists of two main types of component: agents and a manager.

An agent is a management software module that resides in a managed device (the ZyXEL Device). An agent translates the local management information from the managed device into a form compatible with SNMP. The manager is the console through which network administrators perform network management functions. It executes applications that control and monitor managed devices.

The managed devices contain object variables/managed objects that define each piece of information to be collected about a device. Examples of variables include such as number of packets received, node port status etc. A Management Information Base (MIB) is a collection of managed objects. SNMP allows a manager and agents to communicate for the purpose of accessing these objects.

SNMP itself is a simple request/response protocol based on the manager/agent model. The manager issues a request and the agent returns responses using the following protocol operations:

- Get - Allows the manager to retrieve an object variable from the agent.
- GetNext - Allows the manager to retrieve the next object variable from a table or list within an agent. In SNMPv1, when a manager wants to retrieve all elements of a table from an agent, it initiates a Get operation, followed by a series of GetNext operations.
- Set - Allows the manager to set values for object variables within an agent.
- Trap - Used by the agent to inform the manager of some events.

15.6.1 Supported MIBs

The ZyXEL Device supports MIB II that is defined in RFC-1213 and RFC-1215. The focus of the MIBs is to let administrators collect statistical data and monitor status and performance.

15.6.2 SNMP Traps

The ZyXEL Device will send traps to the SNMP manager when any one of the following events occurs:

Table 83 SNMP Traps

TRAP #	TRAP NAME	DESCRIPTION
0	coldStart (defined in <i>RFC-1215</i>)	A trap is sent after booting (power on).
1	warmStart (defined in <i>RFC-1215</i>)	A trap is sent after booting (software reboot).
6	whyReboot (defined in ZYXEL-MIB)	A trap is sent with the reason of restart before rebooting when the system is going to restart (warm start).
6a	For intentional reboot:	A trap is sent with the message "System reboot by user!" if reboot is done intentionally, (for example, download new files, C1 command "sys reboot", etc.).
6b	For fatal error:	A trap is sent with the message of the fatal code if the system reboots because of fatal errors.

15.6.3 Configuring SNMP

To change your ZyXEL Device's SNMP settings, click **Advanced > Remote MGMT > SNMP**. The screen appears as shown.

Figure 115 Remote Management: SNMP

The screenshot displays the SNMP configuration interface. At the top, there are tabs for WWW, Telnet, FTP, **SNMP**, DNS, and ICMP. The main content area is titled "SNMP" and includes the following settings:

- Port: 161
- Access Status: Disable
- Secured Client IP: All Selected

Below this is the "SNMP Configuration" section with the following fields:

- Get Community:
- Set Community:
- TrapCommunity:
- TrapDestination:

A note with a yellow icon states: "Note : You may also need to create a [Firewallrule](#)". At the bottom, there are "Apply" and "Cancel" buttons.

The following table describes the labels in this screen.

Table 84 Remote Management: SNMP

LABEL	DESCRIPTION
SNMP	
Port	You may change the server port number for a service if needed, however you must use the same port number in order to use that service for remote management.
Access Status	Select the interface(s) through which a computer may access the ZyXEL Device using this service.
Secured Client IP	A secured client is a “trusted” computer that is allowed to communicate with the ZyXEL Device using this service. Select All to allow any computer to access the ZyXEL Device using this service. Choose Selected to just allow the computer with the IP address that you specify to access the ZyXEL Device using this service.
SNMP Configuration	
Get Community	Enter the Get Community , which is the password for the incoming Get and GetNext requests from the management station. The default is public and allows all requests.
Set Community	Enter the Set community , which is the password for incoming Set requests from the management station. The default is public and allows all requests.
Trap	
Community	Type the trap community, which is the password sent with each trap to the SNMP manager. The default is public and allows all requests.
Destination	Type the IP address of the station to send your SNMP traps to.
Apply	Click Apply to save your customized settings and exit this screen.
Cancel	Click Cancel to begin configuring this screen afresh.

15.7 Configuring DNS

Use DNS (Domain Name System) to map a domain name to its corresponding IP address and vice versa. Refer to the chapter on LAN for background information.

To change your ZyXEL Device's DNS settings, click **Advanced > Remote MGMT > DNS**. The screen appears as shown. Use this screen to set from which IP address the ZyXEL Device will accept DNS queries and on which interface it can send them your ZyXEL Device's DNS settings.

Figure 116 Remote Management: DNS

The following table describes the labels in this screen.

Table 85 Remote Management: DNS

LABEL	DESCRIPTION
Port	The DNS service port number is 53.
Access Status	Select the interface(s) through which a computer may send DNS queries to the ZyXEL Device.
Secured Client IP	A secured client is a “trusted” computer that is allowed to send DNS queries to the ZyXEL Device. Select All to allow any computer to send DNS queries to the ZyXEL Device. Choose Selected to just allow the computer with the IP address that you specify to send DNS queries to the ZyXEL Device.
Apply	Click Apply to save your customized settings and exit this screen.
Cancel	Click Cancel to begin configuring this screen afresh.

15.8 Configuring ICMP

To change your ZyXEL Device’s security settings, click **Advanced > Remote MGMT > ICMP**. The screen appears as shown.

If an outside user attempts to probe an unsupported port on your ZyXEL Device, an ICMP response packet is automatically returned. This allows the outside user to know the ZyXEL Device exists. Your ZyXEL Device supports anti-probing, which prevents the ICMP response packet from being sent. This keeps outsiders from discovering your ZyXEL Device when unsupported ports are probed.

Figure 117 Remote Management: ICMP

The following table describes the labels in this screen.

Table 86 Remote Management: ICMP

LABEL	DESCRIPTION
ICMP	Internet Control Message Protocol is a message control and error-reporting protocol between a host server and a gateway to the Internet. ICMP uses Internet Protocol (IP) datagrams, but the messages are processed by the TCP/IP software and directly apparent to the application user.
Respond to Ping on	The ZyXEL Device will not respond to any incoming Ping requests when Disable is selected. Select LAN to reply to incoming LAN Ping requests. Select WAN to reply to incoming WAN Ping requests. Otherwise select LAN & WAN to reply to both incoming LAN and WAN Ping requests.
Do not respond to requests for unauthorized services	Select this option to prevent hackers from finding the ZyXEL Device by probing for unused ports. If you select this option, the ZyXEL Device will not respond to port request(s) for unused ports, thus leaving the unused ports and the ZyXEL Device unseen. By default this option is not selected and the ZyXEL Device will reply with an ICMP Port Unreachable packet for a port probe on its unused UDP ports, and a TCP Reset packet for a port probe on its unused TCP ports. Note that the probing packets must first traverse the ZyXEL Device's firewall mechanism before reaching this anti-probing mechanism. Therefore if the firewall mechanism blocks a probing packet, the ZyXEL Device reacts based on the corresponding firewall policy to send a TCP reset packet for a blocked TCP packet or an ICMP port-unreachable packet for a blocked UDP packets or just drop the packets without sending a response packet.
Apply	Click Apply to save your customized settings and exit this screen.
Cancel	Click Cancel to begin configuring this screen afresh.

15.9 TR-069

TR-069 is a protocol that defines how your ZyXEL Device can be managed via a management server such as ZyXEL's Vantage CNM Access.

An administrator can use CNM Access to remotely set up the ZyXEL device, modify settings, perform firmware upgrades as well as monitor and diagnose the ZyXEL device. All you have to do is enable the device to be managed by CNM Access and specify the CNM Access IP address or domain name and username and password.

Follow the procedure below to configure your ZyXEL Device to be managed by CNM Access. See the Command Interpreter appendix for information on the command structure and how to access the CLI (Command Line Interface) on the ZyXEL Device.

Note: In this example **a.b.c.d** is the IP address of CNM Access. You must change this value to reflect your actual management server IP address or domain name. See [Table 87 on page 212](#) for detailed descriptions of the commands.

Figure 118 Enabling TR-069

```

ras> wan tr069 load
ras> wan tr069 acsUrl a.b.c.d
Auto-Configuration Server URL: http://a.b.c.d
ras> wan tr069 periodicEnable 1
ras> wan tr069 informInterval 2400
TR069 Informinterval 2400
ras> wan tr069 active 1
ras> wan tr069 save

```

The following table gives a description of TR-069 commands.

Table 87 TR-069 Commands

Root	Command or Subdirectory	Command	Description
wan	tr069		All TR-069 related commands must be preceded by <code>wan tr069</code> .
		load	Start configuring TR-069 on your ZyXEL Device.
		active [0:no/ 1:yes]	Enable/disable TR-069 operation.
		acsUrl <URL>	Set the IP address or domain name of CNM Access.
		username [maxlength:15]	Username used to authenticate the device when making a connection to CNM Access. This username is set up on the server and must be provided by the CNM Access administrator.
		password [maxlength:15]	Password used to authenticate the device when making a connection to CNM Access. This password is set up on the server and must be provided by the CNM Access administrator.
		periodicEnable [0:Disable/ 1:Enable]	Whether or not the device must periodically send information to CNM Access. It is recommended to set this value to 1 in order for the ZyXEL Device to send information to CNM Access.
		informInterval [sec]	The duration in seconds of the interval for which the device MUST attempt to connect with CNM Access to send information and check for configuration updates. Enter a value between 30 and 2147483647 seconds.
		save	Save the TR-069 settings to your ZyXEL Device.

CHAPTER 16

Universal Plug-and-Play (UPnP)

This chapter introduces the UPnP feature in the web configurator.

16.1 Introducing Universal Plug and Play

Universal Plug and Play (UPnP) is a distributed, open networking standard that uses TCP/IP for simple peer-to-peer network connectivity between devices. A UPnP device can dynamically join a network, obtain an IP address, convey its capabilities and learn about other devices on the network. In turn, a device can leave a network smoothly and automatically when it is no longer in use.

See [Section 16.2.1 on page 215](#) for configuration instructions.

16.1.1 How do I know if I'm using UPnP?

UPnP hardware is identified as an icon in the Network Connections folder (Windows XP). Each UPnP compatible device installed on your network will appear as a separate icon. Selecting the icon of a UPnP device will allow you to access the information and properties of that device.

16.1.2 NAT Traversal

UPnP NAT traversal automates the process of allowing an application to operate through NAT. UPnP network devices can automatically configure network addressing, announce their presence in the network to other UPnP devices and enable exchange of simple product and service descriptions. NAT traversal allows the following:

- Dynamic port mapping
- Learning public IP addresses
- Assigning lease times to mappings

Windows Messenger is an example of an application that supports NAT traversal and UPnP.

See the NAT chapter for more information on NAT.

16.1.3 Cautions with UPnP

The automated nature of NAT traversal applications in establishing their own services and opening firewall ports may present network security issues. Network information and configuration may also be obtained and modified by users in some network environments.

When a UPnP device joins a network, it announces its presence with a multicast message. For security reasons, the ZyXEL Device allows multicast messages on the LAN only.

All UPnP-enabled devices may communicate freely with each other without additional configuration. Disable UPnP if this is not your intention.

16.2 UPnP and ZyXEL

ZyXEL has achieved UPnP certification from the Universal Plug and Play Forum UPnP™ Implementers Corp. (UIC). ZyXEL's UPnP implementation supports Internet Gateway Device (IGD) 1.0.

See the following sections for examples of installing and using UPnP.

16.2.1 Configuring UPnP

Click **Advanced > UPnP** to display the screen shown next.

See [Section 16.1 on page 214](#) for more information.

Figure 119 Configuring UPnP

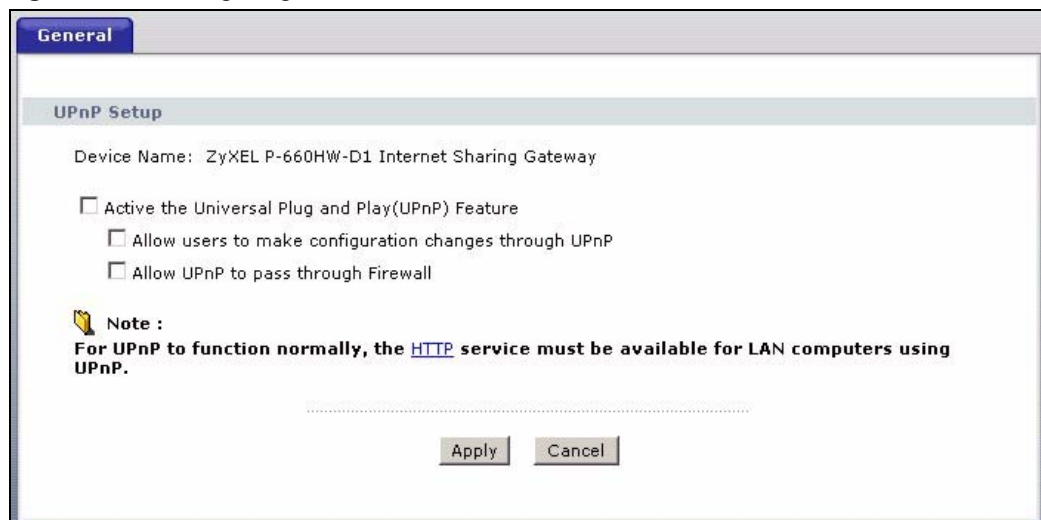

The following table describes the fields in this screen.

Table 88 Configuring UPnP

LABEL	DESCRIPTION
Active the Universal Plug and Play (UPnP) Feature	Select this check box to activate UPnP. Be aware that anyone could use a UPnP application to open the web configurator's login screen without entering the ZyXEL Device's IP address (although you must still enter the password to access the web configurator).
Allow users to make configuration changes through UPnP	Select this check box to allow UPnP-enabled applications to automatically configure the ZyXEL Device so that they can communicate through the ZyXEL Device, for example by using NAT traversal, UPnP applications automatically reserve a NAT forwarding port in order to communicate with another UPnP enabled device; this eliminates the need to manually configure port forwarding for the UPnP enabled application.
Allow UPnP to pass through Firewall	Select this check box to allow traffic from UPnP-enabled applications to bypass the firewall. Clear this check box to have the firewall block all UPnP application packets (for example, MSN packets).
Apply	Click Apply to save the setting to the ZyXEL Device.
Cancel	Click Cancel to return to the previously saved settings.

16.3 Installing UPnP in Windows Example

This section shows how to install UPnP in Windows Me and Windows XP.

16.3.1 Installing UPnP in Windows Me

Follow the steps below to install the UPnP in Windows Me.

- 1 Click **Start** and **Control Panel**. Double-click **Add/Remove Programs**.
- 2 Click on the **Windows Setup** tab and select **Communication** in the **Components** selection box. Click **Details**.

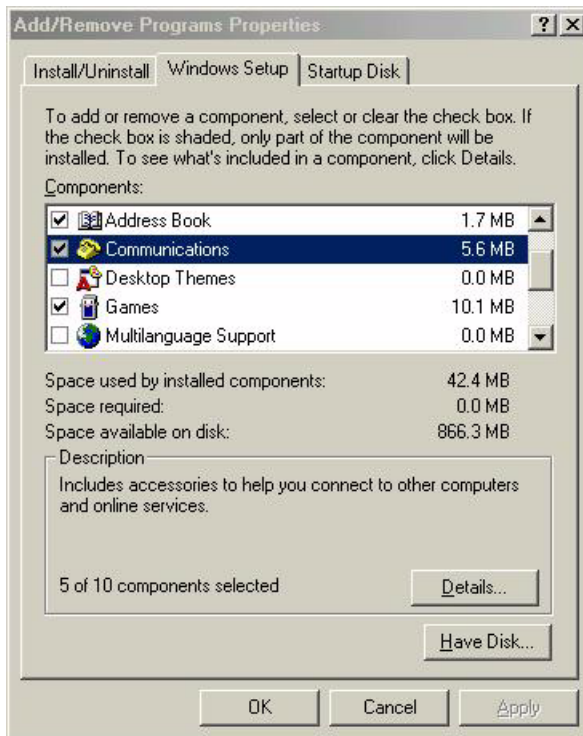
Figure 120 Add/Remove Programs: Windows Setup: Communication

- 3** In the **Communications** window, select the **Universal Plug and Play** check box in the **Components** selection box.

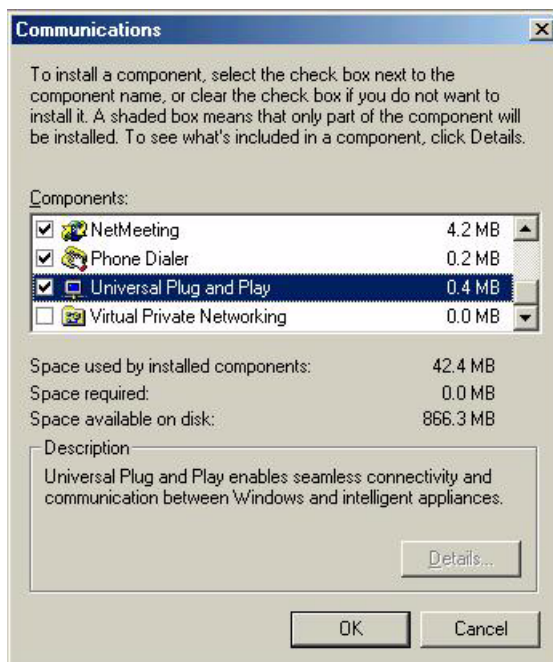
Figure 121 Add/Remove Programs: Windows Setup: Communication: Components

- 4** Click **OK** to go back to the **Add/Remove Programs Properties** window and click **Next**.
- 5** Restart the computer when prompted.

16.3.2 Installing UPnP in Windows XP

Follow the steps below to install the UPnP in Windows XP.

- 1 Click **start** and **Control Panel**.
- 2 Double-click **Network Connections**.
- 3 In the **Network Connections** window, click **Advanced** in the main menu and select **Optional Networking Components ...**.

Figure 122 Network Connections

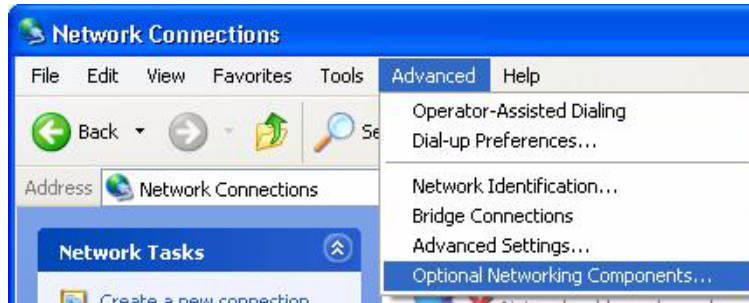

- 4 The **Windows Optional Networking Components Wizard** window displays. Select **Networking Service** in the **Components** selection box and click **Details**.

Figure 123 Windows Optional Networking Components Wizard

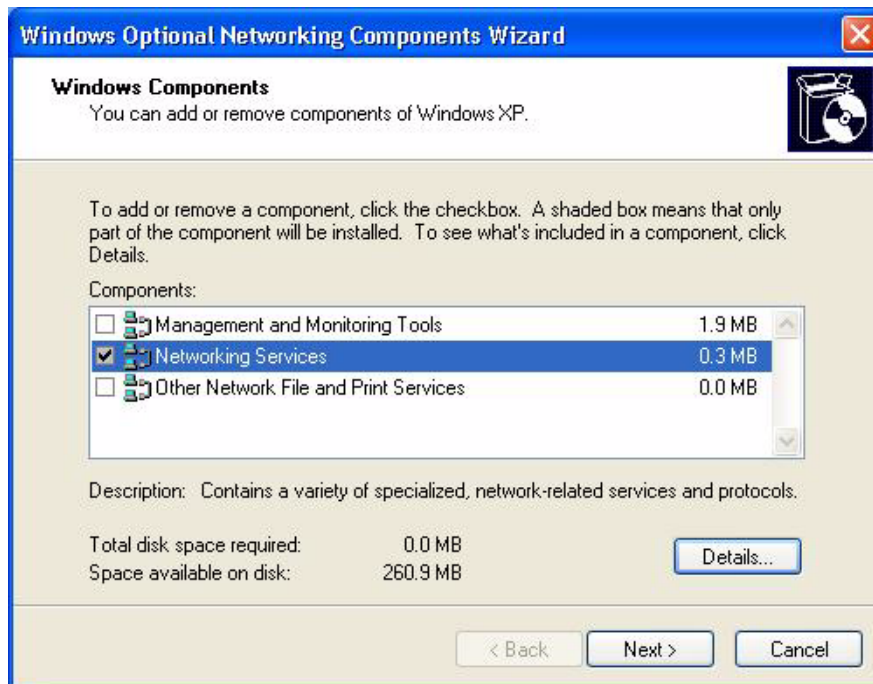

- 5 In the **Networking Services** window, select the **Universal Plug and Play** check box.

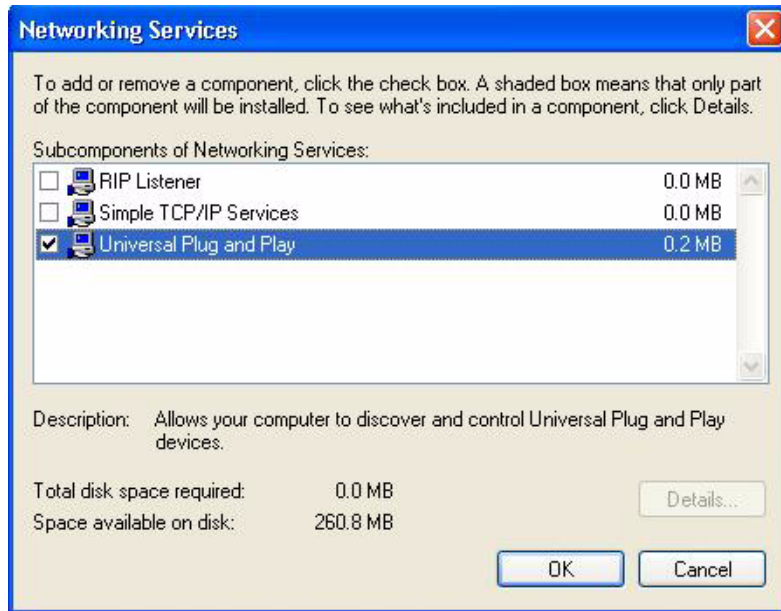
Figure 124 Networking Services

- 6 Click **OK** to go back to the **Windows Optional Networking Component Wizard** window and click **Next**.

16.4 Using UPnP in Windows XP Example

This section shows you how to use the UPnP feature in Windows XP. You must already have UPnP installed in Windows XP and UPnP activated on the ZyXEL Device.

Make sure the computer is connected to a LAN port of the ZyXEL Device. Turn on your computer and the ZyXEL Device.

16.4.1 Auto-discover Your UPnP-enabled Network Device

- 1 Click **start** and **Control Panel**. Double-click **Network Connections**. An icon displays under Internet Gateway.
- 2 Right-click the icon and select **Properties**.

Figure 125 Network Connections

- 3** In the **Internet Connection Properties** window, click **Settings** to see the port mappings there were automatically created.

Figure 126 Internet Connection Properties

- 4** You may edit or delete the port mappings or click **Add** to manually add port mappings.

Figure 127 Internet Connection Properties: Advanced Settings

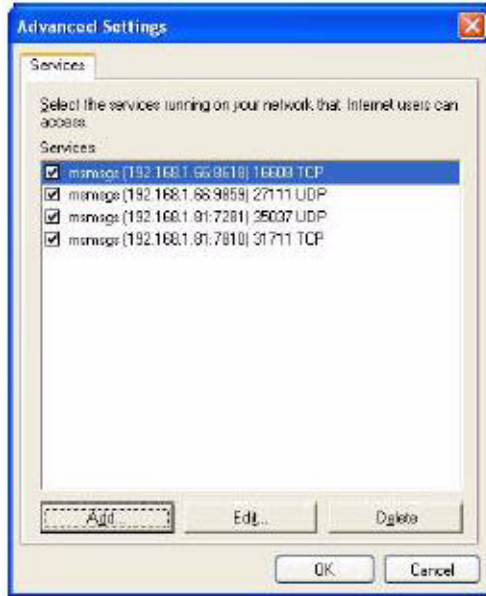
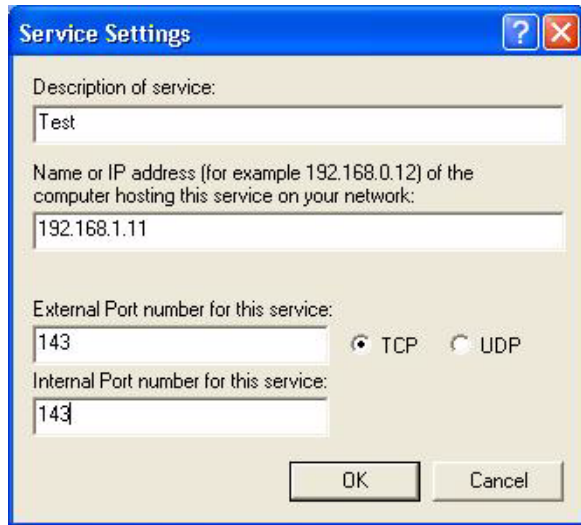

Figure 128 Internet Connection Properties: Advanced Settings: Add



Note: When the UPnP-enabled device is disconnected from your computer, all port mappings will be deleted automatically.

- 5 Select **Show icon in notification area when connected** option and click **OK**. An icon displays in the system tray.

Figure 129 System Tray Icon

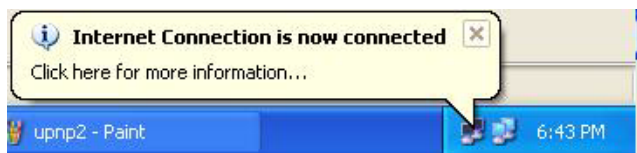

- 6 Double-click on the icon to display your current Internet connection status.

Figure 130 Internet Connection Status



16.4.2 Web Configurator Easy Access

With UPnP, you can access the web-based configurator on the ZyXEL Device without finding out the IP address of the ZyXEL Device first. This comes helpful if you do not know the IP address of the ZyXEL Device.

Follow the steps below to access the web configurator.

- 1 Click **Start** and then **Control Panel**.
- 2 Double-click **Network Connections**.
- 3 Select **My Network Places** under **Other Places**.

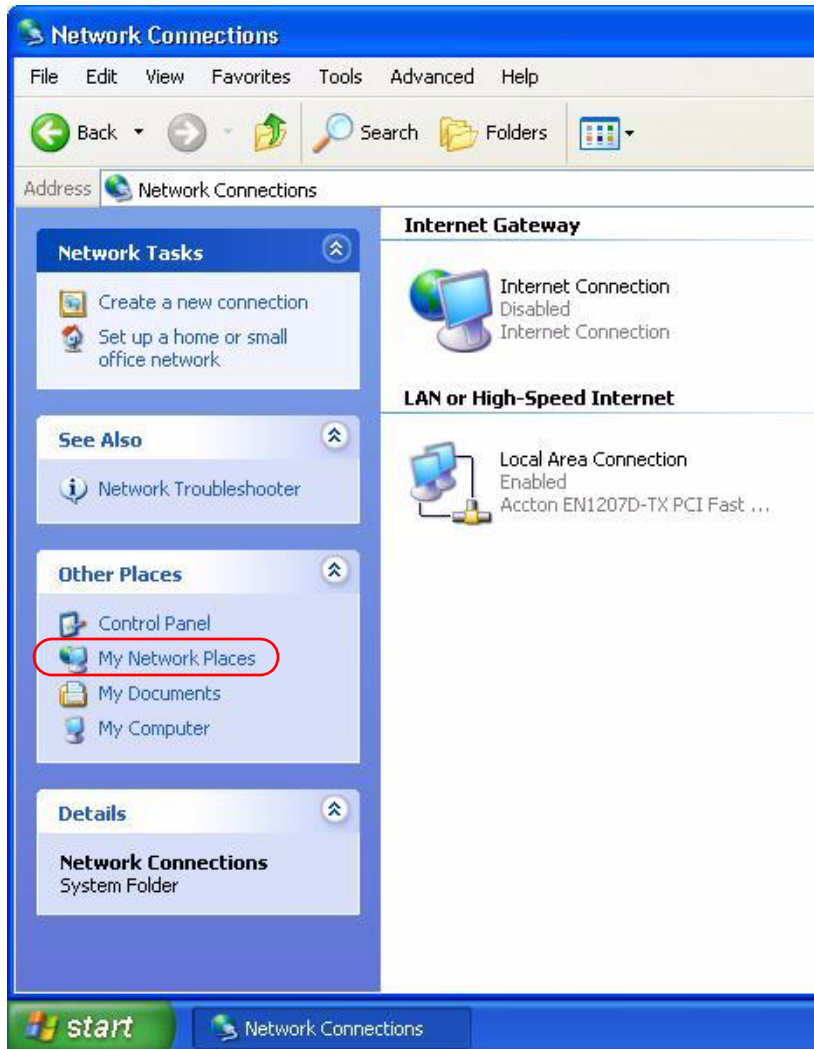
Figure 131 Network Connections

- 4 An icon with the description for each UPnP-enabled device displays under **Local Network**.
- 5 Right-click on the icon for your ZyXEL Device and select **Invoke**. The web configurator login screen displays.

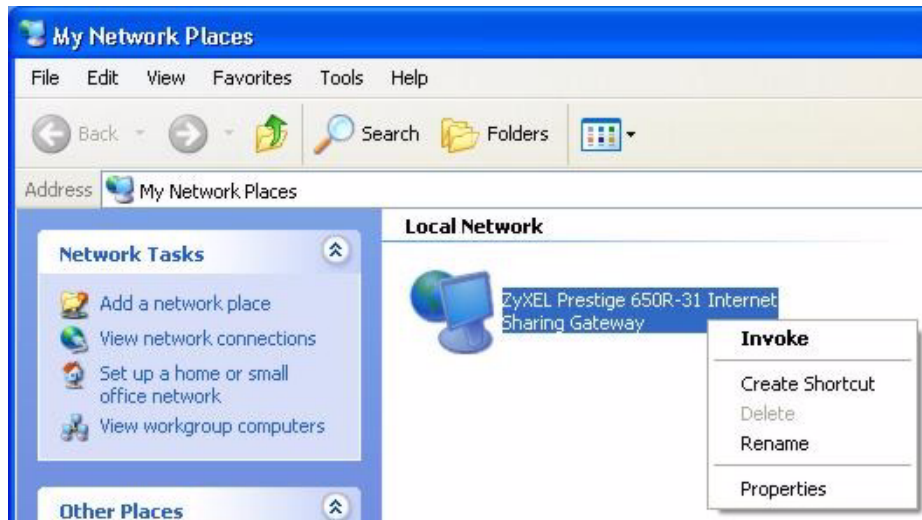
Figure 132 Network Connections: My Network Places

- 6 Right-click on the icon for your ZyXEL Device and select **Properties**. A properties window displays with basic information about the ZyXEL Device.

Figure 133 Network Connections: My Network Places: Properties: Example

CHAPTER 17

System

Use this screen to configure the ZyXEL Device's time and date settings.

17.1 General Setup

17.1.1 General Setup and System Name

General Setup contains administrative and system-related information. **System Name** is for identification purposes. However, because some ISPs check this name you should enter your computer's "Computer Name".

- In Windows 95/98 click **Start, Settings, Control Panel, Network**. Click the Identification tab, note the entry for the **Computer Name** field and enter it as the **System Name**.
- In Windows 2000, click **Start, Settings, Control Panel** and then double-click **System**. Click the **Network Identification** tab and then the **Properties** button. Note the entry for the **Computer name** field and enter it as the **System Name**.
- In Windows XP, click **start, My Computer, View system information** and then click the **Computer Name** tab. Note the entry in the **Full computer name** field and enter it as the ZyXEL Device **System Name**.

17.1.2 General Setup

The **Domain Name** entry is what is propagated to the DHCP clients on the LAN. If you leave this blank, the domain name obtained by DHCP from the ISP is used. While you must enter the host name (System Name), the domain name can be assigned from the ZyXEL Device via DHCP.

Click **Maintenance > System** to open the **General** screen.

Figure 134 System General Setup

The following table describes the labels in this screen.

Table 89 System General Setup

LABEL	DESCRIPTION
General Setup	
System Name	Choose a descriptive name for identification purposes. It is recommended you enter your computer's "Computer name" in this field. This name can be up to 30 alphanumeric characters long. Spaces are not allowed, but dashes "-" and underscores "_" are accepted.
Domain Name	Enter the domain name (if you know it) here. If you leave this field blank, the ISP may assign a domain name via DHCP. The domain name entered by you is given priority over the ISP assigned domain name.
Administrator Inactivity Timer	Type how many minutes a management session can be left idle before the session times out. The default is 5 minutes. After it times out you have to log in with your password again. Very long idle timeouts may have security risks. A value of "0" means a management session never times out, no matter how long it has been left idle (not recommended).
Password	
User Password	If you log in with the user password, you can only view the ZyXEL Device status. The default user password is user .
New Password	Type your new system password (up to 30 characters). Note that as you type a password, the screen displays a (*) for each character you type. After you change the password, use the new password to access the ZyXEL Device.
Retype to Confirm	Type the new password again for confirmation.

Table 89 System General Setup

LABEL	DESCRIPTION
Admin Password	If you log in with the admin password, you can configure the advanced features as well as the wizard setup on the ZyXEL Device.
Old Password	Type the default admin password (1234) or the existing password you use to access the system for configuring advanced features.
New Password	Type your new system password (up to 30 characters). Note that as you type a password, the screen displays a (*) for each character you type. After you change the password, use the new password to access the ZyXEL Device.
Retype to Confirm	Type the new password again for confirmation.
Apply	Click Apply to save your changes back to the ZyXEL Device.
Cancel	Click Cancel to begin configuring this screen afresh.

17.2 Time Setting

To change your ZyXEL Device's time and date, click **Maintenance > System > Time Setting**. The screen appears as shown. Use this screen to configure the ZyXEL Device's time based on your local time zone.

Figure 135 System Time Setting

The following table describes the fields in this screen.

Table 90 System Time Setting

LABEL	DESCRIPTION
Current Time and Date	
Current Time	This field displays the time of your ZyXEL Device. Each time you reload this page, the ZyXEL Device synchronizes the time with the time server.
Current Date	This field displays the date of your ZyXEL Device. Each time you reload this page, the ZyXEL Device synchronizes the date with the time server.
Time and Date Setup	
Manual	Select this radio button to enter the time and date manually. If you configure a new time and date, Time Zone and Daylight Saving at the same time, the new time and date you entered has priority and the Time Zone and Daylight Saving settings do not affect it.
New Time (hh:mm:ss)	This field displays the last updated time from the time server or the last time configured manually. When you set Time and Date Setup to Manual , enter the new time in this field and then click Apply .
New Date (yyyy/mm/dd)	This field displays the last updated date from the time server or the last date configured manually. When you set Time and Date Setup to Manual , enter the new date in this field and then click Apply .
Get from Time Server	Select this radio button to have the ZyXEL Device get the time and date from the time server you specified below.
Time Protocol	Select the time service protocol that your time server uses. Not all time servers support all protocols, so you may have to check with your ISP/network administrator or use trial and error to find a protocol that works. The main difference between them is the format. Daytime (RFC 867) format is day/month/year/time zone of the server. Time (RFC 868) format displays a 4-byte integer giving the total number of seconds since 1970/1/1 at 0:0:0. The default, NTP (RFC 1305) , is similar to Time (RFC 868).
Time Server Address	Enter the IP address or URL (up to 20 extended ASCII characters in length) of your time server. Check with your ISP/network administrator if you are unsure of this information.
Time Zone Setup	
Time Zone	Choose the time zone of your location. This will set the time difference between your time zone and Greenwich Mean Time (GMT).
Enable Daylight Savings	Daylight saving is a period from late spring to early fall when many countries set their clocks ahead of normal local time by one hour to give more daytime light in the evening. Select this option if you use Daylight Saving Time.

Table 90 System Time Setting (continued)

LABEL	DESCRIPTION
Start Date	<p>Configure the day and time when Daylight Saving Time starts if you selected Enable Daylight Saving. The o'clock field uses the 24 hour format. Here are a couple of examples:</p> <p>Daylight Saving Time starts in most parts of the United States on the first Sunday of April. Each time zone in the United States starts using Daylight Saving Time at 2 A.M. local time. So in the United States you would select First, Sunday, April and type 2 in the o'clock field.</p> <p>Daylight Saving Time starts in the European Union on the last Sunday of March. All of the time zones in the European Union start using Daylight Saving Time at the same moment (1 A.M. GMT or UTC). So in the European Union you would select Last, Sunday, March. The time you type in the o'clock field depends on your time zone. In Germany for instance, you would type 2 because Germany's time zone is one hour ahead of GMT or UTC (GMT+1).</p>
End Date	<p>Configure the day and time when Daylight Saving Time ends if you selected Enable Daylight Saving. The o'clock field uses the 24 hour format. Here are a couple of examples:</p> <p>Daylight Saving Time ends in the United States on the last Sunday of October. Each time zone in the United States stops using Daylight Saving Time at 2 A.M. local time. So in the United States you would select Last, Sunday, October and type 2 in the o'clock field.</p> <p>Daylight Saving Time ends in the European Union on the last Sunday of October. All of the time zones in the European Union stop using Daylight Saving Time at the same moment (1 A.M. GMT or UTC). So in the European Union you would select Last, Sunday, October. The time you type in the o'clock field depends on your time zone. In Germany for instance, you would type 2 because Germany's time zone is one hour ahead of GMT or UTC (GMT+1).</p>
Apply	Click Apply to save your changes back to the ZyXEL Device.
Cancel	Click Cancel to begin configuring this screen afresh.

CHAPTER 18

Logs

This chapter contains information about configuring general log settings and viewing the ZyXEL Device's logs. Refer to the appendix for example log message explanations.

18.1 Logs Overview

The web configurator allows you to choose which categories of events and/or alerts to have the ZyXEL Device log and then display the logs or have the ZyXEL Device send them to an administrator (as e-mail) or to a syslog server.

18.1.1 Alerts and Logs

An alert is a type of log that warrants more serious attention. They include system errors, attacks (access control) and attempted access to blocked web sites. Some categories such as **System Errors** consist of both logs and alerts. You may differentiate them by their color in the **View Log** screen. Alerts display in red and logs display in black.

18.2 Viewing the Logs

Click **Maintenance > Logs** to open the **View Log** screen. Use the **View Log** screen to see the logs for the categories that you selected in the **Log Settings** screen (see [Section 18.3 on page 233](#)).

Log entries in red indicate alerts. The log wraps around and deletes the old entries after it fills. Click a column heading to sort the entries. A triangle indicates ascending or descending sort order.

Figure 136 View Log

#	Time	Message	Source	Destination	Notes
1	01/01/2000 00:33:40	WEB Login Successfully			User:admin
2	01/01/2000 00:31:32	none: UDP	192.168.1.1:53	192.168.1.34:1197	ACCESS PERMITTED
3	01/01/2000 00:31:32	none: UDP	192.168.1.1:53	192.168.1.34:1196	ACCESS PERMITTED
4	01/01/2000 00:31:32	none: UDP	192.168.1.1:53	192.168.1.34:1195	ACCESS PERMITTED
5	01/01/2000 00:30:23	WEB Login Successfully			User:user

The following table describes the fields in this screen.

Table 91 View Log

LABEL	DESCRIPTION
Display	The categories that you select in the Log Settings screen display in the drop-down list box. Select a category of logs to view; select All Logs to view logs from all of the log categories that you selected in the Log Settings page.
Time	This field displays the time the log was recorded.
Message	This field states the reason for the log.
Source	This field lists the source IP address and the port number of the incoming packet.
Destination	This field lists the destination IP address and the port number of the incoming packet.
Notes	This field displays additional information about the log entry.
Email Log Now	Click Email Log Now to send the log screen to the e-mail address specified in the Log Settings page (make sure that you have first filled in the E-mail Log Settings fields in Log Settings).
Refresh	Click Refresh to renew the log screen.
Clear Log	Click Clear Log to delete all the logs.

18.3 Configuring Log Settings

Use the **Log Settings** screen to configure to where the ZyXEL Device is to send logs; the schedule for when the ZyXEL Device is to send the logs and which logs and/or immediate alerts the ZyXEL Device is to record. See [Section 18.1 on page 232](#) for more information.

To change your ZyXEL Device's log settings, click **Maintenance > Logs > Log Settings**. The screen appears as shown.

Alerts are e-mailed as soon as they happen. Logs may be e-mailed as soon as the log is full. Selecting many alert and/or log categories (especially **Access Control**) may result in many e-mails being sent.

Figure 137 Log Settings

The following table describes the fields in this screen.

Table 92 Log Settings

LABEL	DESCRIPTION
E-mail Log Settings	
Mail Server	Enter the server name or the IP address of the mail server for the e-mail addresses specified below. If this field is left blank, logs and alert messages will not be sent via E-mail.
Mail Subject	Type a title that you want to be in the subject line of the log e-mail message that the ZyXEL Device sends. Not all ZyXEL models have this field.

Table 92 Log Settings

LABEL	DESCRIPTION
Send Log To	The ZyXEL Device sends logs to the e-mail address specified in this field. If this field is left blank, the ZyXEL Device does not send logs via e-mail.
Send Alerts To	Alerts are real-time notifications that are sent as soon as an event, such as a DoS attack, system error, or forbidden web access attempt occurs. Enter the E-mail address where the alert messages will be sent. Alerts include system errors, attacks and attempted access to blocked web sites. If this field is left blank, alert messages will not be sent via E-mail.
Enable SMTP Authentication	SMTP (Simple Mail Transfer Protocol) is the message-exchange standard for the Internet. SMTP enables you to move messages from one e-mail server to another. Select the check box to activate SMTP authentication. If mail server authentication is needed but this feature is disabled, you will not receive the e-mail logs.
User Name	Enter the user name (up to 31 characters) (usually the user name of a mail account).
Password	Enter the password associated with the user name above.
Log Schedule	This drop-down menu is used to configure the frequency of log messages being sent as E-mail: <ul style="list-style-type: none"> • Daily • Weekly • Hourly • When Log is Full • None. If you select Weekly or Daily , specify a time of day when the E-mail should be sent. If you select Weekly , then also specify which day of the week the E-mail should be sent. If you select When Log is Full , an alert is sent when the log fills up. If you select None , no log messages are sent.
Day for Sending Log	Use the drop down list box to select which day of the week to send the logs.
Time for Sending Log	Enter the time of the day in 24-hour format (for example 23:00 equals 11:00 pm) to send the logs.
Clear log after sending mail	Select the checkbox to delete all the logs after the ZyXEL Device sends an E-mail of the logs.
Syslog Logging	The ZyXEL Device sends a log to an external syslog server.
Active	Click Active to enable syslog logging.
Syslog Server IP Address	Enter the server name or IP address of the syslog server that will log the selected categories of logs.
Log Facility	Select a location from the drop down list box. The log facility allows you to log the messages to different files in the syslog server. Refer to the syslog server manual for more information.
Active Log and Alert	
Log	Select the categories of logs that you want to record.
Send Immediate Alert	Select log categories for which you want the ZyXEL Device to send E-mail alerts immediately.
Apply	Click Apply to save your customized settings and exit this screen.
Cancel	Click Cancel to return to the previously saved settings.

18.3.1 Example E-mail Log

An "End of Log" message displays for each mail in which a complete log has been sent. The following is an example of a log sent by e-mail.

- You may edit the subject title.
- The date format here is Day-Month-Year.
- The date format here is Month-Day-Year. The time format is Hour-Minute-Second.
- "End of Log" message shows that a complete log has been sent.

Figure 138 E-mail Log Example

```
Subject:
  Firewall Alert From xxxxx
Date:
  Fri, 07 Apr 2000 10:05:42
From:
  user@zyxel.com
To:
  user@zyxel.com
1|Apr 7 00 |From:192.168.1.1      To:192.168.1.255  |default policy |forward
  | 09:54:03 |UDP      src port:00520 dest port:00520  |<1,00>         |
2|Apr 7 00 |From:192.168.1.131   To:192.168.1.255  |default policy |forward
  | 09:54:17 |UDP      src port:00520 dest port:00520  |<1,00>         |
3|Apr 7 00 |From:192.168.1.6     To:10.10.10.10 |match           |forward
  | 09:54:19 |UDP      src port:03516 dest port:00053  |<1,01>         |
.....{snip}.....
.....{snip}.....
126|Apr 7 00 |From:192.168.1.1     To:192.168.1.255  |match           |forward
  | 10:05:00 |UDP      src port:00520 dest port:00520  |<1,02>         |
127|Apr 7 00 |From:192.168.1.131   To:192.168.1.255  |match           |forward
  | 10:05:17 |UDP      src port:00520 dest port:00520  |<1,02>         |
128|Apr 7 00 |From:192.168.1.1     To:192.168.1.255  |match           |forward
  | 10:05:30 |UDP      src port:00520 dest port:00520  |<1,02>         |
End of Firewall Log
```

CHAPTER 19

Tools

This chapter describes how to upload new firmware, manage configuration and restart your ZyXEL Device.

19.1 Firmware Upgrade

Find firmware at www.zyxel.com in a file that (usually) uses the system model name with a .bin extension, for example, "ZyXEL Device.bin". The upload process uses HTTP (Hypertext Transfer Protocol) and may take up to two minutes. After a successful upload, the system will reboot.

Only use firmware for your device's specific model. Refer to the label on the bottom of your device.

Click **Maintenance > Tools** to open the **Firmware** screen. Follow the instructions in this screen to upload firmware to your ZyXEL Device.

Figure 139 Firmware Upgrade

The following table describes the labels in this screen.

Table 93 Firmware Upgrade

LABEL	DESCRIPTION
Current Firmware Version	This is the present Firmware version and the date created.
File Path	Type in the location of the file you want to upload in this field or click Browse ... to find it.

Table 93 Firmware Upgrade (continued)

LABEL	DESCRIPTION
Browse...	Click Browse... to find the .bin file you want to upload. Remember that you must decompress compressed (.zip) files before you can upload them.
Upload	Click Upload to begin the upload process. This process may take up to two minutes.

Note: Do NOT turn off the ZyXEL Device while firmware upload is in progress!

After you see the **Firmware Upload in Progress** screen, wait two minutes before logging into the ZyXEL Device again.

Figure 140 Firmware Upload In Progress



The ZyXEL Device automatically restarts in this time causing a temporary network disconnect. In some operating systems, you may see the following icon on your desktop.

Figure 141 Network Temporarily Disconnected



After two minutes, log in again and check your new firmware version in the **Status** screen.

If the upload was not successful, the following screen will appear. Click **Return** to go back to the **Firmware** screen.

Figure 142 Error Message

19.2 Configuration Screen

Click **Maintenance > Tools > Configuration**. Information related to factory defaults, backup configuration, and restoring configuration appears as shown next.

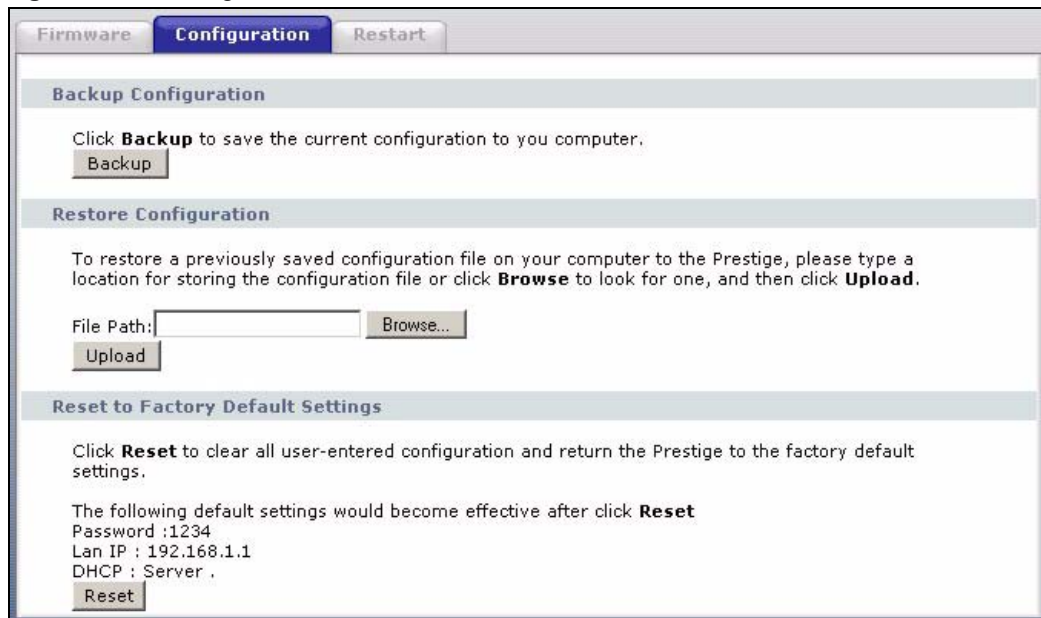
Figure 143 Configuration

19.2.1 Backup Configuration

Backup configuration allows you to back up (save) the ZyXEL Device's current configuration to a file on your computer. Once your ZyXEL Device is configured and functioning properly, it is highly recommended that you back up your configuration file before making configuration changes. The backup configuration file will be useful in case you need to return to your previous settings.

Click **Backup** to save the ZyXEL Device's current configuration to your computer

19.2.2 Restore Configuration

Restore configuration allows you to upload a new or previously saved configuration file from your computer to your ZyXEL Device.

Table 94 Maintenance Restore Configuration

LABEL	DESCRIPTION
File Path	Type in the location of the file you want to upload in this field or click Browse... to find it.
Browse...	Click Browse... to find the file you want to upload. Remember that you must decompress compressed (.ZIP) files before you can upload them.
Upload	Click Upload to begin the upload process.

Note: Do not turn off the ZyXEL Device while configuration file upload is in progress

After you see a “Restore Configuration successful” screen, you must then wait one minute before logging into the ZyXEL Device again.

Figure 144 Configuration Restore Successful



The ZyXEL Device automatically restarts in this time causing a temporary network disconnect. In some operating systems, you may see the following icon on your desktop.

Figure 145 Temporarily Disconnected



If you uploaded the default configuration file you may need to change the IP address of your computer to be in the same subnet as that of the default ZyXEL Device IP address (192.168.1.1). See the appendix for details on how to set up your computer's IP address.

If the upload was not successful, the following screen will appear. Click **Return** to go back to the **Configuration** screen.

Figure 146 Configuration Restore Error

19.2.3 Back to Factory Defaults

Pressing the **RESET** button in this section clears all user-entered configuration information and returns the ZyXEL Device to its factory defaults.

You can also press the **RESET** button on the rear panel to reset the factory defaults of your ZyXEL Device. Refer to the chapter about introducing the web configurator for more information on the **RESET** button.

19.3 Restart

System restart allows you to reboot the ZyXEL Device without turning the power off.

Click **Maintenance > Tools > Restart**. Click **Restart** to have the ZyXEL Device reboot. This does not affect the ZyXEL Device's configuration.

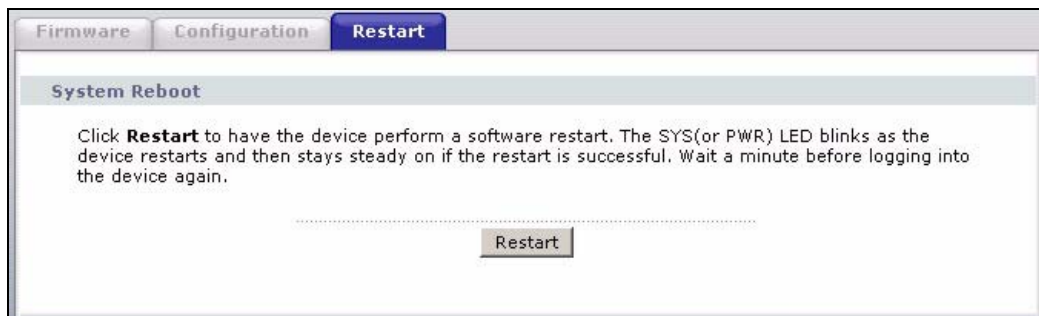
Figure 147 Restart Screen

CHAPTER 20

Diagnostic

These read-only screens display information to help you identify problems with the ZyXEL Device.

20.1 General Diagnostic

Click **Maintenance > Diagnostic** to open the screen shown next.

Figure 148 Diagnostic: General

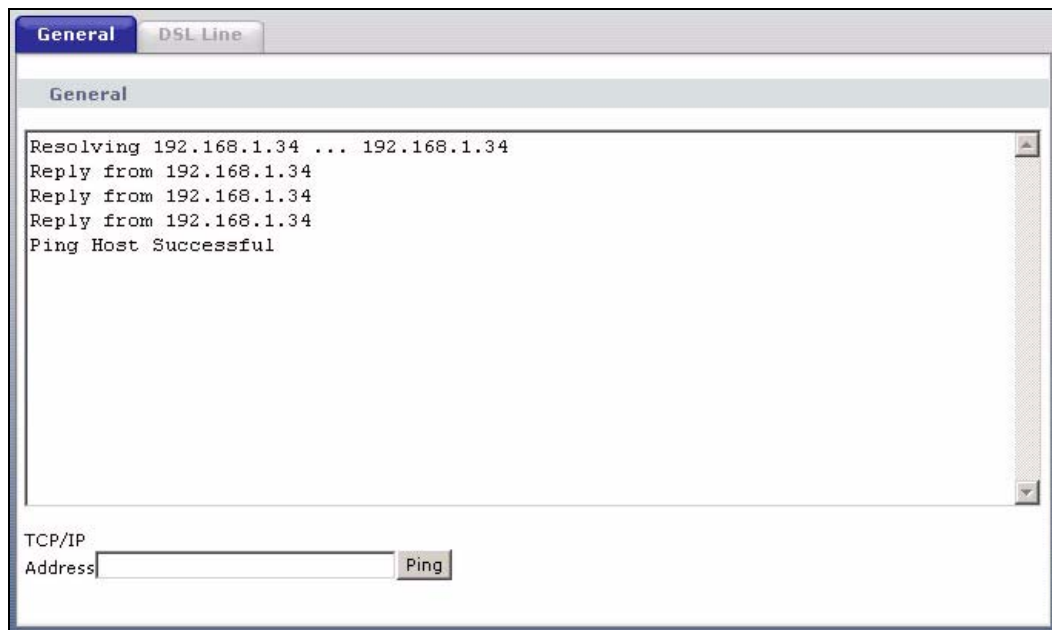

The following table describes the fields in this screen.

Table 95 Diagnostic: General

LABEL	DESCRIPTION
TCP/IP Address	Type the IP address of a computer that you want to ping in order to test a connection.
Ping	Click this button to ping the IP address that you entered.

20.2 DSL Line Diagnostic

Click **Maintenance > Diagnostic > DSL Line** to open the screen shown next.

Figure 149 Diagnostic: DSL Line

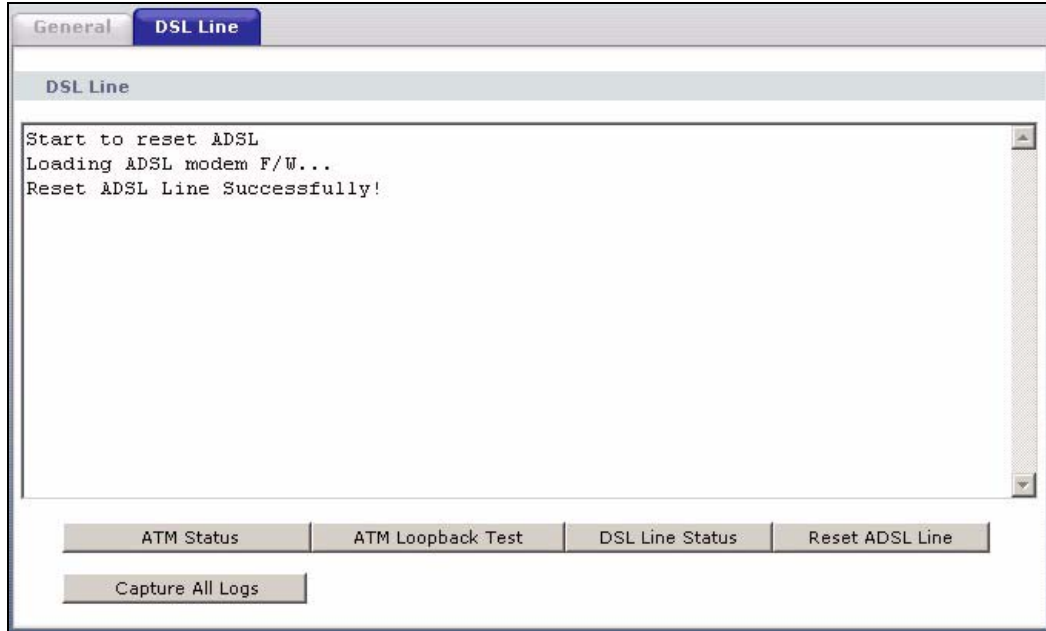

The following table describes the fields in this screen.

Table 96 Diagnostic: DSL Line

LABEL	DESCRIPTION
ATM Status	Click this button to view ATM status.
ATM Loopback Test	Click this button to start the ATM loopback test. Make sure you have configured at least one PVC with proper VPIs/VCIs before you begin this test. The ZyXEL Device sends an OAM F5 packet to the DSLAM/ATM switch and then returns it (loops it back) to the ZyXEL Device. The ATM loopback test is useful for troubleshooting problems with the DSLAM and ATM network.
DSL Line Status	Click this button to view the DSL port's line operating values and line bit allocation.
Reset ADSL Line	Click this button to reinitialize the ADSL line. The large text box above then displays the progress and results of this operation, for example: "Start to reset ADSL Loading ADSL modem F/W... Reset ADSL Line Successfully!"
Capture All Logs	Click this button to display all logs generated with the DSL line.

CHAPTER 21

Troubleshooting

This chapter covers potential problems and the corresponding remedies.

21.1 Problems Starting Up the ZyXEL Device

Table 97 Troubleshooting Starting Up Your ZyXEL Device

PROBLEM	CORRECTIVE ACTION
None of the LEDs turn on when I turn on the ZyXEL Device.	<p>Make sure that the ZyXEL Device's power adaptor is connected to the ZyXEL Device and plugged in to an appropriate power source. Make sure that the ZyXEL Device and the power source are both turned on.</p> <p>Turn the ZyXEL Device off and on.</p> <p>If the error persists, you may have a hardware problem. In this case, you should contact your vendor.</p>

21.2 Problems with the LAN

Table 98 Troubleshooting the LAN

PROBLEM	CORRECTIVE ACTION
The LAN LEDs do not turn on.	<p>Check your Ethernet cable connections (refer to the Quick Start Guide for details). Check for faulty Ethernet cables.</p>
	<p>Make sure your computer's Ethernet Card is working properly.</p>
I cannot access the ZyXEL Device from the LAN.	<p>If Any IP is disabled, make sure that the IP address and the subnet mask of the ZyXEL Device and your computer(s) are on the same subnet.</p>

21.3 Problems with the WAN

Table 99 Troubleshooting the WAN

PROBLEM	CORRECTIVE ACTION
The DSL LED is off.	Check the telephone wire and connections between the ZyXEL Device DSL port and the wall jack.
	Make sure that the telephone company has checked your phone line and set it up for DSL service.
	Reset your ADSL line to reinitialize your link to the DSLAM. For details, refer to the Table 96 on page 245 .
I cannot get a WAN IP address from the ISP.	The ISP provides the WAN IP address after authenticating you. Authentication may be through the user name and password, the MAC address or the host name. The username and password apply to PPPoE and PPPoA encapsulation only. Make sure that you have entered the correct Service Type , User Name and Password (be sure to use the correct casing). Refer to the WAN Setup chapter.
I cannot access the Internet.	Make sure the ZyXEL Device is turned on and connected to the network. Verify your WAN settings. Refer to the chapter on WAN setup. Make sure you entered the correct user name and password. If you use PPPoE pass through, make sure that bridge mode is turned on.
The Internet connection disconnects.	Check the schedule rules. If you use PPPoA or PPPoE encapsulation, check the idle time-out setting. Refer to the Chapter 5 on page 76 . Contact your ISP.

21.4 Problems Accessing the ZyXEL Device

Table 100 Troubleshooting Accessing the ZyXEL Device

PROBLEM	CORRECTIVE ACTION
I cannot access the ZyXEL Device.	<p>The default user password is "user" and admin password is "1234". The Password field is case-sensitive. Make sure that you enter the correct password using the proper case.</p> <p>If you have changed the password and have now forgotten it, you will need to upload the default configuration file. This restores all of the factory defaults including the password.</p>
I cannot access the web configurator.	<p>Make sure that there is not a Telnet session running.</p> <p>Use the ZyXEL Device's WAN IP address when configuring from the WAN. Refer to the instructions on checking your WAN connection.</p> <p>Use the ZyXEL Device's LAN IP address when configuring from the LAN. Refer to for instructions on checking your LAN connection.</p> <p>Check that you have enabled web service access. If you have configured a secured client IP address, your computer's IP address must match it. Refer to the chapter on remote management for details.</p> <p>Your computer's and the ZyXEL Device's IP addresses must be on the same subnet for LAN access.</p> <p>If you changed the ZyXEL Device's LAN IP address, then enter the new one as the URL.</p> <p>Make sure that pop-up windows, JavaScripts and Java permissions are allowed. See the appendix for how to enable them.</p>

APPENDIX A

Product Specifications

See also the Introduction chapter for a general overview of the key features.

Specification Tables

Table 101 Device

Default IP Address	192.168.1.1
Default Subnet Mask	255.255.255.0 (24 bits)
Default Password	1234
DHCP Pool	192.168.1.33 to 192.168.1.64
Dimensions (W x D x H)	180 x 128 x 36 mm
Power Specification	12VAC 1A
Built-in Switch	Four auto-negotiating, auto MDI/MDI-X 10/100 Mbps RJ-45 Ethernet ports
Operation Temperature	0° C ~ 40° C
Storage Temperature	-20° ~ 60° C
Operation Humidity	20% ~ 85% RH
Storage Humidity	10% ~ 90% RH
Distance between the centers of the holes on the device's back.	108 mm
Screw size for wall-mounting	M3*10

Table 102 Firmware

ADSL Standards	Multi-Mode standard (ANSI T1.413, Issue 2; G.dmt(G.992.1); G.lite(G.992.2)). ADSL2 G.dmt.bis (G.992.3) ADSL2 G.lite.bis (G.992.4) ADSL2+ (G.992.5) Reach-Extended ADSL (RE ADSL) SRA (Seamless Rate Adaptation) Auto-negotiating rate adaptation ADSL physical connection ATM AAL5 (ATM Adaptation Layer type 5) Multi-protocol over AAL5 (RFC2684/1483) PPP over ATM AAL5 (RFC 2364) PPP over Ethernet (RFC 2516) RFC 1483 encapsulation over ATM MAC encapsulated routing (ENET encapsulation) VC-based and LLC-based multiplexing Up to 8 PVCs (Permanent Virtual Circuits) I.610 F4/F5 OAM
Other Protocol Support	PPP (Point-to-Point Protocol) link layer protocol. Transparent bridging for unsupported network layer protocols. DHCP Server/Client/Relay RIP I/RIP II ICMP ATM QoS SNMP v1 and v2c with MIB II support (RFC 1213) IP Multicasting IGMP v1 and v2 IGMP Proxy UPnP
Management	Embedded Web Configurator CLI (Command Line Interpreter) Remote Management via Telnet or Web SNMP manageable FTP/TFTP for firmware downloading, configuration backup and restoration. Syslog Built-in Diagnostic Tools for FLASH memory, ADSL circuitry, RAM and LAN port MAP - "Multimedia Auto Provisioner" (multimedia installation tutorial and automatic configurator) TR-069 (P-660H-D only)
Wireless (P-660HW-D only)	IEEE 802.11g compliance Frequency Range: 2.4 GHz Advanced Orthogonal Frequency Division Multiplexing (OFDM) Data Rates: 54Mbps and Auto Fallback Wired Equivalent Privacy (WEP) Data Encryption 64/128/256 bit WLAN bridge to LAN Up to 32 MAC address filters WPA(2), WPA(2)-PSK IEEE 802.1x External RADIUS server using EAP-MD5, TLS, TTLS

Table 102 Firmware (continued)

Firewall	Stateful Packet Inspection. Prevent Denial of Service attacks such as Ping of Death, SYN Flood, LAND, Smurf etc. Real time E-mail alerts. Reports and logs.
NAT/SUA	Port Forwarding 1024 NAT sessions Multimedia application PPTP under NAT/SUA IPSec passthrough SIP ALG passthrough VPN passthrough
Content Filtering	Web page blocking by URL keyword.
Static Routes	16 IP and 4 Bridge
Other Features	Any IP Zero Configuration (VC auto-hunting) Traffic Redirect Dynamic DNS IP Alias MBM (Multimedia Bandwidth Management) QoS (Quality of Service)

APPENDIX B

About ADSL

Introduction to DSL

DSL (Digital Subscriber Line) technology enhances the data capacity of the existing twisted-pair wire that runs between the local telephone company switching offices and most homes and offices. While the wire itself can handle higher frequencies, the telephone switching equipment is designed to cut off signals above 4,000 Hz to filter noise off the voice line, but now everybody is searching for ways to get more bandwidth to improve access to the Web - hence DSL technologies.

There are actually seven types of DSL service, ranging in speeds from 16 Kbits/sec to 52 Mbits/sec. The services are either symmetrical (traffic flows at the same speed in both directions), or asymmetrical (the downstream capacity is higher than the upstream capacity). Asymmetrical services (ADSL) are suitable for Internet users because more information is usually downloaded than uploaded. For example, a simple button click in a web browser can start an extended download that includes graphics and text.

As data rates increase, the carrying distance decreases. That means that users who are beyond a certain distance from the telephone company's central office may not be able to obtain the higher speeds.

A DSL connection is a point-to-point dedicated circuit, meaning that the link is always up and there is no dialing required.

ADSL Overview

Asynchronous Digital Subscriber Line (ADSL) technology provides high-speed data access across regular telephone or ISDN lines by making use of previously unused high-frequency bandwidth. ADSL is asymmetric in the sense that it provides a higher downstream data rate transfer (up to 8Mbps), than in the upstream transfer (up to 832 Kbps). Asymmetric operation is ideal for typical home and small office use where files and information are downloaded more frequently than uploaded.

Advantages of ADSL

- 1 ADSL provides a private (unlike cable telephone and modem services where the line is shared), dedicated and secure channel of communications between you and your service provider.

- 2** Because your line is dedicated (not shared), transmission speeds between you and the device to which you connect at your service provider are not affected by other users. With cable modems, transmission speeds drop significantly as more users go on-line because the line is shared.
- 3** ADSL can be "always on" (connected). This means that there is no time wasted dialing up the service several times a day and waiting to be connected; ADSL is on standby, ready for use whenever you need it.

APPENDIX C

Internal SPTGEN

This appendix introduces Internal SPTGEN. All menus shown in this appendix are example menus meant to show SPTGEN usage. Actual menus for your product may differ.

Internal SPTGEN Overview

Internal SPTGEN (System Parameter Table Generator) is a configuration text file useful for efficient configuration of multiple ZyXEL Devices. Internal SPTGEN lets you configure, save and upload multiple menus at the same time using just one configuration text file – eliminating the need to navigate and configure individual screens for each ZyXEL Device. You can use FTP to get the Internal SPTGEN file. Then edit the file in a text editor and use FTP to upload it again to the same device or another one. See the following sections for details.

The Configuration Text File Format

All Internal SPTGEN text files conform to the following format:

```
<field identification number = field name = parameter values
allowed = input>,
```

where <input> is your input conforming to <parameter values allowed>.

The figure shown next is an example of an Internal SPTGEN text file.

Figure 150 Configuration Text File Format: Column Descriptions

/ Menu 1 General Setup		
10000000 = Configured	<0 (No) 1 (Yes)>	= 1
10000001 = System Name	<Str>	= Your Device
10000002 = Location	<Str>	=
10000003 = Contact Person's Name	<Str>	=
10000004 = Route IP	<0 (No) 1 (Yes)>	= 1
10000005 = Route IPX	<0 (No) 1 (Yes)>	= 0
10000006 = Bridge	<0 (No) 1 (Yes)>	= 0

Note: DO NOT alter or delete any field except parameters in the Input column.

This appendix introduces Internal SPTGEN. All menus shown in this appendix are example menus meant to show SPTGEN usage. Actual menus for your product may differ.

Internal SPTGEN File Modification - Important Points to Remember

Each parameter you enter must be preceded by one “=” sign and one space.

Some parameters are dependent on others. For example, if you disable the **Configured** field in menu 1 (see [Figure 150 on page 256](#)), then you disable every field in this menu.

If you enter a parameter that is invalid in the **Input** column, the ZyXEL Device will not save the configuration and the command line will display the **Field Identification Number**. [Figure 151 on page 257](#), shown next, is an example of what the ZyXEL Device displays if you enter a value other than “0” or “1” in the **Input** column of **Field Identification Number 1000000** (refer to [Figure 150 on page 256](#)).

Figure 151 Invalid Parameter Entered: Command Line Example

```
field value is not legal error:-1
ROM-t is not saved, error Line ID:10000000
reboot to get the original configuration
Bootbase Version: V2.02 | 2/22/2001 13:33:11
RAM: Size = 8192 Kbytes
FLASH: Intel 8M *2
```

The ZyXEL Device will display the following if you enter parameter(s) that *are* valid.

Figure 152 Valid Parameter Entered: Command Line Example

```
Please wait for the system to write SPT text file(ROM-t)...
Bootbase Version: V2.02 | 2/22/2001 13:33:11
RAM: Size = 8192 Kbytes
FLASH: Intel 8M *2
```

Internal SPTGEN FTP Download Example

- 1 Launch your FTP application.
- 2 Enter "bin". The command “bin” sets the transfer mode to binary.
- 3 Get "rom-t" file. The command “get” transfers files from the ZyXEL Device to your computer. The name “rom-t” is the configuration filename on the ZyXEL Device.
- 4 Edit the "rom-t" file using a text editor (do not use a word processor). You must leave this FTP screen to edit.

Figure 153 Internal SPTGEN FTP Download Example

```
c:\ftp 192.168.1.1
220 PPP FTP version 1.0 ready at Sat Jan 1 03:22:12 2000
User (192.168.1.1:(none)):
331 Enter PASS command
Password:
230 Logged in
ftp>bin
200 Type I OK
ftp> get rom-t
ftp>bye
c:\edit rom-t
(edit the rom-t text file by a text editor and save it)
```

Note: You can rename your “rom-t” file when you save it to your computer but it must be named “rom-t” when you upload it to your ZyXEL Device.

Internal SPTGEN FTP Upload Example

- 1 Launch your FTP application.
- 2 Enter "bin". The command “bin” sets the transfer mode to binary.
- 3 Upload your “rom-t” file from your computer to the ZyXEL Device using the “put” command. computer to the ZyXEL Device.
- 4 Exit this FTP application.

Figure 154 Internal SPTGEN FTP Upload Example

```
c:\ftp 192.168.1.1
220 PPP FTP version 1.0 ready at Sat Jan 1 03:22:12 2000
User (192.168.1.1:(none)):
331 Enter PASS command
Password:
230 Logged in
ftp>bin
200 Type I OK
ftp> put rom-t
ftp>bye
```

Example Internal SPTGEN Menus

This section provides example Internal SPTGEN menus.

Table 103 Abbreviations Used in the Example Internal SPTGEN Screens Table

ABBREVIATION	MEANING
FIN	Field Identification Number
FN	Field Name
PVA	Parameter Values Allowed
INPUT	An example of what you may enter
*	Applies to the ZyXEL Device.

Table 104 Menu 1 General Setup

/ Menu 1 General Setup			
FIN	FN	PVA	INPUT
10000000 =	Configured	<0 (No) 1 (Yes)>	= 0
10000001 =	System Name	<Str>	= Your Device
10000002 =	Location	<Str>	=
10000003 =	Contact Person's Name	<Str>	=
10000004 =	Route IP	<0 (No) 1 (Yes)>	= 1
10000006 =	Bridge	<0 (No) 1 (Yes)>	= 0

Table 105 Menu 3

/ Menu 3.1 General Ethernet Setup			
FIN	FN	PVA	INPUT
30100001 =	Input Protocol filters Set 1		= 2
30100002 =	Input Protocol filters Set 2		= 256
30100003 =	Input Protocol filters Set 3		= 256
30100004 =	Input Protocol filters Set 4		= 256
30100005 =	Input device filters Set 1		= 256
30100006 =	Input device filters Set 2		= 256
30100007 =	Input device filters Set 3		= 256
30100008 =	Input device filters Set 4		= 256
30100009 =	Output protocol filters Set 1		= 256
30100010 =	Output protocol filters Set 2		= 256
30100011 =	Output protocol filters Set 3		= 256

Table 105 Menu 3

30100012 =	Output protocol filters Set 4		= 256
30100013 =	Output device filters Set 1		= 256
30100014 =	Output device filters Set 2		= 256
30100015 =	Output device filters Set 3		= 256
30100016 =	Output device filters Set 4		= 256
/ Menu 3.2 TCP/IP and DHCP Ethernet Setup			
FIN	FN	PVA	INPUT
30200001 =	DHCP	<0 (None) 1 (Server) 2 (Relay)>	= 0
30200002 =	Client IP Pool Starting Address		= 192.168.1.33
30200003 =	Size of Client IP Pool		= 32
30200004 =	Primary DNS Server		= 0.0.0.0
30200005 =	Secondary DNS Server		= 0.0.0.0
30200006 =	Remote DHCP Server		= 0.0.0.0
30200008 =	IP Address		= 172.21.2.200
30200009 =	IP Subnet Mask		= 16
30200010 =	RIP Direction	<0 (None) 1 (Both) 2 (In Only) 3 (Out Only)>	= 0
30200011 =	Version	<0 (Rip-1) 1 (Rip-2B) 2 (Rip-2M)>	= 0
30200012 =	Multicast	<0 (IGMP-v2) 1 (IGMP-v1) 2 (None)>	= 2
30200013 =	IP Policies Set 1 (1~12)		= 256
30200014 =	IP Policies Set 2 (1~12)		= 256
30200015 =	IP Policies Set 3 (1~12)		= 256
30200016 =	IP Policies Set 4 (1~12)		= 256
/ Menu 3.2.1 IP Alias Setup			
FIN	FN	PVA	INPUT
30201001 =	IP Alias 1	<0 (No) 1 (Yes)>	= 0
30201002 =	IP Address		= 0.0.0.0
30201003 =	IP Subnet Mask		= 0
30201004 =	RIP Direction	<0 (None) 1 (Both) 2 (In Only) 3 (Out Only)>	= 0

Table 105 Menu 3

30201005 =	Version	<0 (Rip-1) 1 (Rip-2B) 2 (Rip-2M) >	= 0
30201006 =	IP Alias #1 Incoming protocol filters Set 1		= 256
30201007 =	IP Alias #1 Incoming protocol filters Set 2		= 256
30201008 =	IP Alias #1 Incoming protocol filters Set 3		= 256
30201009 =	IP Alias #1 Incoming protocol filters Set 4		= 256
30201010 =	IP Alias #1 Outgoing protocol filters Set 1		= 256
30201011 =	IP Alias #1 Outgoing protocol filters Set 2		= 256
30201012 =	IP Alias #1 Outgoing protocol filters Set 3		= 256
30201013 =	IP Alias #1 Outgoing protocol filters Set 4		= 256
30201014 =	IP Alias 2 <0 (No) 1 (Yes) >		= 0
30201015 =	IP Address		= 0.0.0.0
30201016 =	IP Subnet Mask		= 0
30201017 =	RIP Direction	<0 (None) 1 (Both) 2 (In Only) 3 (Out Only) >	= 0
30201018 =	Version	<0 (Rip-1) 1 (Rip-2B) 2 (Rip-2M) >	= 0
30201019 =	IP Alias #2 Incoming protocol filters Set 1		= 256
30201020 =	IP Alias #2 Incoming protocol filters Set 2		= 256
30201021 =	IP Alias #2 Incoming protocol filters Set 3		= 256
30201022 =	IP Alias #2 Incoming protocol filters Set 4		= 256
30201023 =	IP Alias #2 Outgoing protocol filters Set 1		= 256
30201024 =	IP Alias #2 Outgoing protocol filters Set 2		= 256
30201025 =	IP Alias #2 Outgoing protocol filters Set 3		= 256
30201026 =	IP Alias #2 Outgoing protocol filters Set 4		= 256

*/ Menu 3.5 Wireless LAN Setup

Table 105 Menu 3

FIN	FN	PVA	INPUT
30500001 =	ESSID		Wireless
30500002 =	Hide ESSID	<0 (No) 1 (Yes)>	= 0
30500003 =	Channel ID	<1 2 3 4 5 6 7 8 9 10 11 12 13>	= 1
30500004 =	RTS Threshold	<0 ~ 2432>	= 2432
30500005 =	FRAG. Threshold	<256 ~ 2432>	= 2432
30500006 =	WEP	<0 (DISABLE) 1 (64-bit WEP) 2 (128-bit WEP)>	= 0
30500007 =	Default Key	<1 2 3 4>	= 0
30500008 =	WEP Key1		=
30500009 =	WEP Key2		=
30500010 =	WEP Key3		=
30500011 =	WEP Key4		=
30500012 =	Wlan Active	<0 (Disable) 1 (Enable)>	= 0
30500013 =	Wlan 4X Mode	<0 (Disable) 1 (Enable)>	= 0
*/ MENU 3.5.1 WLAN MAC ADDRESS FILTER			
FIN	FN	PVA	INPUT
30501001 =	Mac Filter Active	<0 (No) 1 (Yes)>	= 0
30501002 =	Filter Action	<0 (Allow) 1 (Deny)>	= 0
30501003 =	Address 1		= 00:00:00:00:0 0:00
30501004 =	Address 2		= 00:00:00:00:0 0:00
30501005 =	Address 3		= 00:00:00:00:0 0:00
Continued
30501034 =	Address 32		= 00:00:00:00:0 0:00

Table 106 Menu 4 Internet Access Setup

/ Menu 4 Internet Access Setup			
FIN	FN	PVA	INPUT
40000000 =	Configured	<0 (No) 1 (Yes)>	= 1
40000001 =	ISP	<0 (No) 1 (Yes)>	= 1
40000002 =	Active	<0 (No) 1 (Yes)>	= 1
40000003 =	ISP's Name		= ChangeMe
40000004 =	Encapsulation	<2 (PPPOE) 3 (RFC 1483) 4 (PPPoA) 5 (ENET ENCAP)>	= 2
40000005 =	Multiplexing	<1 (LLC-based) 2 (VC-based)>	= 1
40000006 =	VPI #		= 0
40000007 =	VCI #		= 35
40000008 =	Service Name	<Str>	= any
40000009 =	My Login	<Str>	= test@pqa
40000010 =	My Password	<Str>	= 1234
40000011 =	Single User Account	<0 (No) 1 (Yes)>	= 1
40000012 =	IP Address Assignment	<0 (Static) 1 (D ynamic)>	= 1
40000013 =	IP Address		= 0.0.0.0
40000014 =	Remote IP address		= 0.0.0.0
40000015 =	Remote IP subnet mask		= 0
40000016 =	ISP incoming protocol filter set 1		= 6
40000017 =	ISP incoming protocol filter set 2		= 256
40000018 =	ISP incoming protocol filter set 3		= 256
40000019 =	ISP incoming protocol filter set 4		= 256
40000020 =	ISP outgoing protocol filter set 1		= 256
40000021 =	ISP outgoing protocol filter set 2		= 256
40000022 =	ISP outgoing protocol filter set 3		= 256
40000023 =	ISP outgoing protocol filter set 4		= 256
40000024 =	ISP PPPoE idle timeout		= 0
40000025 =	Route IP	<0 (No) 1 (Yes)>	= 1
40000026 =	Bridge	<0 (No) 1 (Yes)>	= 0

Table 106 Menu 4 Internet Access Setup (continued)

40000027 =	ATM QoS Type	<0 (CBR) 1 (UBR)>	= 1
40000028 =	Peak Cell Rate (PCR)		= 0
40000029 =	Sustain Cell Rate (SCR)		= 0
40000030 =	Maximum Burst Size (MBS)		= 0
40000031=	RIP Direction	<0 (None) 1 (Both) 2 (In Only) 3 (Out Only)>	= 0
40000032=	RIP Version	<0 (Rip-1) 1 (Rip-2B) 2 (Rip-2M)>	= 0
40000033=	Nailed-up Connection	<0 (No) 1 (Yes)>	= 0

Table 107 Menu 12

/ Menu 12.1.1 IP Static Route Setup			
FIN	FN	PVA	INPUT
120101001 =	IP Static Route set #1, Name	<Str>	=
120101002 =	IP Static Route set #1, Active	<0 (No) 1 (Yes)>	= 0
120101003 =	IP Static Route set #1, Destination IP address		= 0.0.0.0
120101004 =	IP Static Route set #1, Destination IP subnetmask		= 0
120101005 =	IP Static Route set #1, Gateway		= 0.0.0.0
120101006 =	IP Static Route set #1, Metric		= 0
120101007 =	IP Static Route set #1, Private	<0 (No) 1 (Yes)>	= 0
/ Menu 12.1.2 IP Static Route Setup			
FIN	FN	PVA	INPUT
120108001 =	IP Static Route set #8, Name	<Str>	=
120108002 =	IP Static Route set #8, Active	<0 (No) 1 (Yes)>	= 0
120108003 =	IP Static Route set #8, Destination IP address		= 0.0.0.0
120108004 =	IP Static Route set #8, Destination IP subnetmask		= 0
120108005 =	IP Static Route set #8, Gateway		= 0.0.0.0
120108006 =	IP Static Route set #8, Metric		= 0
120108007 =	IP Static Route set #8, Private	<0 (No) 1 (Yes)>	= 0

Table 108 Menu 15 SUA Server Setup

/ Menu 15 SUA Server Setup			
FIN	FN	PVA	INPUT
150000001 =	SUA Server IP address for default port		= 0.0.0.0
150000002 =	SUA Server #2 Active	<0 (No) 1 (Yes)>	= 0
150000003 =	SUA Server #2 Protocol	<0 (All) 6 (TCP) 17 (UDP)>	= 0
150000004 =	SUA Server #2 Port Start		= 0
150000005 =	SUA Server #2 Port End		= 0
150000006 =	SUA Server #2 Local IP address		= 0.0.0.0
150000007 =	SUA Server #3 Active	<0 (No) 1 (Yes)>	= 0
150000008 =	SUA Server #3 Protocol	<0 (All) 6 (TCP) 17 (UDP)>	= 0
150000009 =	SUA Server #3 Port Start		= 0
150000010 =	SUA Server #3 Port End		= 0
150000011 =	SUA Server #3 Local IP address		= 0.0.0.0
150000012 =	SUA Server #4 Active	<0 (No) 1 (Yes)>	= 0
150000013 =	SUA Server #4 Protocol	<0 (All) 6 (TCP) 17 (UDP)>	= 0
150000014 =	SUA Server #4 Port Start		= 0
150000015 =	SUA Server #4 Port End		= 0
150000016 =	SUA Server #4 Local IP address		= 0.0.0.0
150000017 =	SUA Server #5 Active	<0 (No) 1 (Yes)>	= 0
150000018 =	SUA Server #5 Protocol	<0 (All) 6 (TCP) 17 (UDP)>	= 0
150000019 =	SUA Server #5 Port Start		= 0
150000020 =	SUA Server #5 Port End		= 0
150000021 =	SUA Server #5 Local IP address		= 0.0.0.0
150000022 =	SUA Server #6 Active	<0 (No) 1 (Yes)> = 0	= 0
150000023 =	SUA Server #6 Protocol	<0 (All) 6 (TCP) 17 (UDP)>	= 0
150000024 =	SUA Server #6 Port Start		= 0
150000025 =	SUA Server #6 Port End		= 0
150000026 =	SUA Server #6 Local IP address		= 0.0.0.0
150000027 =	SUA Server #7 Active	<0 (No) 1 (Yes)>	= 0
150000028 =	SUA Server #7 Protocol	<0 (All) 6 (TCP) 17 (UDP)>	= 0.0.0.0
150000029 =	SUA Server #7 Port Start		= 0
150000030 =	SUA Server #7 Port End		= 0

Table 108 Menu 15 SUA Server Setup (continued)

150000031 =	SUA Server #7 Local IP address		= 0.0.0.0
150000032 =	SUA Server #8 Active	<0 (No) 1 (Yes)>	= 0
150000033 =	SUA Server #8 Protocol	<0 (All) 6 (TCP) 17 (UDP)>	= 0
150000034 =	SUA Server #8 Port Start		= 0
150000035 =	SUA Server #8 Port End		= 0
150000036 =	SUA Server #8 Local IP address		= 0.0.0.0
150000037 =	SUA Server #9 Active	<0 (No) 1 (Yes)>	= 0
150000038 =	SUA Server #9 Protocol	<0 (All) 6 (TCP) 17 (UDP)>	= 0
150000039 =	SUA Server #9 Port Start		= 0
150000040 =	SUA Server #9 Port End		= 0
150000041 =	SUA Server #9 Local IP address		= 0.0.0.0
150000042 =	SUA Server #10 Active	<0 (No) 1 (Yes)>	= 0
150000043 =	SUA Server #10 Protocol	<0 (All) 6 (TCP) 17 (UDP)>	= 0
150000044 =	SUA Server #10 Port Start		= 0
150000045 =	SUA Server #10 Port End		= 0
150000046 =	SUA Server #10 Local IP address		= 0.0.0.0
150000047 =	SUA Server #11 Active	<0 (No) 1 (Yes)>	= 0
150000048 =	SUA Server #11 Protocol	<0 (All) 6 (TCP) 17 (UDP)>	= 0
150000049 =	SUA Server #11 Port Start		= 0
150000050 =	SUA Server #11 Port End		= 0
150000051 =	SUA Server #11 Local IP address		= 0.0.0.0
150000052 =	SUA Server #12 Active	<0 (No) 1 (Yes)>	= 0
150000053 =	SUA Server #12 Protocol	<0 (All) 6 (TCP) 17 (UDP)>	= 0
150000054 =	SUA Server #12 Port Start		= 0
150000055 =	SUA Server #12 Port End		= 0
150000056 =	SUA Server #12 Local IP address		= 0.0.0.0

Table 109 Menu 21.1 Filter Set #1

/ Menu 21 Filter set #1			
FIN	FN	PVA	INPUT
210100001 =	Filter Set 1, Name	<Str>	=
/ Menu 21.1.1.1 set #1, rule #1			
FIN	FN	PVA	INPUT
210101001 =	IP Filter Set 1, Rule 1 Type	<2 (TCP/IP)>	= 2

Table 109 Menu 21.1 Filter Set #1 (continued)

210101002 =	IP Filter Set 1,Rule 1 Active	<0 (No) 1 (Yes)>	= 1
210101003 =	IP Filter Set 1,Rule 1 Protocol		= 6
210101004 =	IP Filter Set 1,Rule 1 Dest IP address		= 0.0.0.0
210101005 =	IP Filter Set 1,Rule 1 Dest Subnet Mask		= 0
210101006 =	IP Filter Set 1,Rule 1 Dest Port		= 137
210101007 =	IP Filter Set 1,Rule 1 Dest Port Comp	<0 (none) 1 (equal) 2 (not equal) 3 (less) 4 (greater)>	= 1
210101008 =	IP Filter Set 1,Rule 1 Src IP address		= 0.0.0.0
210101009 =	IP Filter Set 1,Rule 1 Src Subnet Mask		= 0
210101010 =	IP Filter Set 1,Rule 1 Src Port		= 0
210101011 =	IP Filter Set 1,Rule 1 Src Port Comp	<0 (none) 1 (equal) 2 (not equal) 3 (less) 4 (greater)>	= 0
210101013 =	IP Filter Set 1,Rule 1 Act Match	<1 (check next) 2 (forward) 3 (drop)>	= 3
210101014 =	IP Filter Set 1,Rule 1 Act Not Match	<1 (check next) 2 (forward) 3 (drop)>	= 1
/ Menu 21.1.1.2 set #1, rule #2			
FIN	FN	PVA	INPUT
210102001 =	IP Filter Set 1,Rule 2 Type	<2 (TCP/IP)>	= 2
210102002 =	IP Filter Set 1,Rule 2 Active	<0 (No) 1 (Yes)>	= 1
210102003 =	IP Filter Set 1,Rule 2 Protocol		= 6
210102004 =	IP Filter Set 1,Rule 2 Dest IP address		= 0.0.0.0
210102005 =	IP Filter Set 1,Rule 2 Dest Subnet Mask		= 0
210102006 =	IP Filter Set 1,Rule 2 Dest Port		= 138
210102007 =	IP Filter Set 1,Rule 2 Dest Port Comp	<0 (none) 1 (equal) 2 (not equal) 3 (less) 4 (greater)>	= 1
210102008 =	IP Filter Set 1,Rule 2 Src IP address		= 0.0.0.0
210102009 =	IP Filter Set 1,Rule 2 Src Subnet Mask		= 0
210102010 =	IP Filter Set 1,Rule 2 Src Port		= 0
210102011 =	IP Filter Set 1,Rule 2 Src Port Comp	<0 (none) 1 (equal) 2 (not equal) 3 (less) 4 (greater)>	= 0

Table 109 Menu 21.1 Filter Set #1 (continued)

210102013 =	IP Filter Set 1,Rule 2 Act Match	<1 (check next) 2 (forward) 3 (drop)>	= 3
210102014 =	IP Filter Set 1,Rule 2 Act Not Match	<1 (check next) 2 (forward) 3 (drop)>	= 1

Table 110 Menu 21.1 Filer Set #2,

/ Menu 21.1 filter set #2,			
FIN	FN	PVA	INPUT
210200001 =	Filter Set 2, Nam	<Str>	= NetBIOS_WAN
/ Menu 21.1.2.1 Filter set #2, rule #1			
FIN	FN	PVA	INPUT
210201001 =	IP Filter Set 2, Rule 1 Type	<0 (none) 2 (TCP/IP)>	= 2
210201002 =	IP Filter Set 2, Rule 1 Active	<0 (No) 1 (Yes)>	= 1
210201003 =	IP Filter Set 2, Rule 1 Protocol		= 6
210201004 =	IP Filter Set 2, Rule 1 Dest IP address		= 0.0.0.0
210201005 =	IP Filter Set 2, Rule 1 Dest Subnet Mask		= 0
210201006 =	IP Filter Set 2, Rule 1 Dest Port		= 137
210201007 =	IP Filter Set 2, Rule 1 Dest Port Comp	<0 (none) 1 (equal) 2 (not equal) 3 (less) 4 (greater)>	= 1
210201008 =	IP Filter Set 2, Rule 1 Src IP address		= 0.0.0.0
210201009 =	IP Filter Set 2, Rule 1 Src Subnet Mask		= 0
210201010 =	IP Filter Set 2, Rule 1 Src Port		= 0
210201011 =	IP Filter Set 2, Rule 1 Src Port Comp	<0 (none) 1 (equal) 2 (not equal) 3 (less) 4 (greater)>	= 0
210201013 =	IP Filter Set 2, Rule 1 Act Match	<1 (check next) 2 (forward) 3 (drop)>	= 3
210201014 =	IP Filter Set 2, Rule 1 Act Not Match	<1 (check next) 2 (forward) 3 (drop)>	= 1
/ Menu 21.1.2.2 Filter set #2, rule #2			
FIN	FN	PVA	INPUT

Table 110 Menu 21.1 Filer Set #2, (continued)

210202001 =	IP Filter Set 2, Rule 2 Type	<0 (none) 2 (TCP/IP)>	= 2
210202002 =	IP Filter Set 2, Rule 2 Active	<0 (No) 1 (Yes)>	= 1
210202003 =	IP Filter Set 2, Rule 2 Protocol		= 6
210202004 =	IP Filter Set 2, Rule 2 Dest IP address		= 0.0.0.0
210202005 =	IP Filter Set 2, Rule 2 Dest Subnet Mask		= 0
210202006 =	IP Filter Set 2, Rule 2 Dest Port		= 138
210202007 =	IP Filter Set 2, Rule 2 Dest Port Comp	<0 (none) 1 (equal) 2 (not equal) 3 (less) 4 (greater)>	= 1
210202008 =	IP Filter Set 2, Rule 2 Src IP address		= 0.0.0.0
210202009 =	IP Filter Set 2, Rule 2 Src Subnet Mask		= 0
210202010 =	IP Filter Set 2, Rule 2 Src Port		= 0
210202011 =	IP Filter Set 2, Rule 2 Src Port Comp	<0 (none) 1 (equal) 2 (not equal) 3 (less) 4 (greater)>	= 0
210202013 =	IP Filter Set 2, Rule 2 Act Match	<1 (check next) 2 (forward) 3 (drop)>	= 3
210202014 =	IP Filter Set 2, Rule 2 Act Not Match	<1 (check next) 2 (forward) 3 (drop)>	= 1

Table 111 Menu 23 System Menus

*/ Menu 23.1 System Password Setup			
FIN	FN	PVA	INPUT
230000000 =	System Password		= 1234
*/ Menu 23.2 System security: radius server			
FIN	FN	PVA	INPUT
230200001 =	Authentication Server Configured	<0 (No) 1 (Yes)>	= 1
230200002 =	Authentication Server Active	<0 (No) 1 (Yes)>	= 1
230200003 =	Authentication Server IP Address		= 192.168.1.32
230200004 =	Authentication Server Port		= 1822

Table 111 Menu 23 System Menus (continued)

230200005 =	Authentication Server Shared Secret		= 111111111111 111 111111111111 1111
230200006 =	Accounting Server Configured	<0 (No) 1 (Yes)>	= 1
230200007 =	Accounting Server Active	<0 (No) 1 (Yes)>	= 1
230200008 =	Accounting Server IP Address		= 192.168.1.44
230200009 =	Accounting Server Port		= 1823
230200010 =	Accounting Server Shared Secret		= 1234
*/ Menu 23.4 System security: IEEE802.1x			
FIN	FN	PVA	INPUT
230400001 =	Wireless Port Control	<0 (Authentication Required) 1 (No Access Allowed) 2 (No Authentication Required)>	= 2
230400002 =	ReAuthentication Timer (in second)		= 555
230400003 =	Idle Timeout (in second)		= 999
230400004 =	Authentication Databases	<0 (Local User Database Only) 1 (RADIUS Only) 2 (Local, RADIUS) 3 (RADIUS, Local)>	= 1
230400005 =	Key Management Protocol	<0 (8021x) 1 (WPA) 2 (WPA2)>	= 0
230400006 =	Dynamic WEP Key Exchange	<0 (Disable) 1 (64-bit WEP) 2 (128-bit WEP)>	= 0
230400007 =	PSK =		=
230400008 =	WPA Mixed Mode	<0 (Disable) 1 (Enable)>	= 0
230400009 =	Data Privacy for Broadcast/Multicast packets	<0 (TKIP) 1 (WEP)>	= 0
230400010 =	WPA Broadcast/Multicast Key Update Timer		= 0

Table 112 Menu 24.11 Remote Management Control

/ Menu 24.11 Remote Management Control			
FIN	FN	PVA	INPUT
241100001 =	TELNET Server Port		= 23

Table 112 Menu 24.11 Remote Management Control (continued)

241100002 =	TELNET Server Access	<0 (all) 1 (none) 2 (Lan) 3 (Wan) >	= 0
241100003 =	TELNET Server Secured IP address		= 0.0.0.0
241100004 =	FTP Server Port		= 21
241100005 =	FTP Server Access	<0 (all) 1 (none) 2 (Lan) 3 (Wan) >	= 0
241100006 =	FTP Server Secured IP address		= 0.0.0.0
241100007 =	WEB Server Port		= 80
241100008 =	WEB Server Access	<0 (all) 1 (none) 2 (Lan) 3 (Wan) >	= 0
241100009 =	WEB Server Secured IP address		= 0.0.0.0

Command Examples

The following are example Internal SPTGEN screens associated with the ZyXEL Device's command interpreter commands.

Table 113 Command Examples

FIN	FN	PVA	INPUT
/ci command (for annex a): wan adsl opencmd			
FIN	FN	PVA	INPUT
990000001 =	ADSL OPMD	<0 (glite) 1 (t1.413) 2 (gdm) 3 (multimode) >	= 3
/ci command (for annex B): wan adsl opencmd			
FIN	FN	PVA	INPUT
990000001 =	ADSL OPMD	<0 (etsi) 1 (normal) 2 (gdm) 3 (multimode) >	= 3

APPENDIX D

Wall-mounting Instructions

Do the following to hang your ZyXEL Device on a wall.

Note: See the product specifications appendix for the size of screws to use and how far apart to place them.

- 1 Locate a high position on wall that is free of obstructions. Use a sturdy wall.
- 2 Drill two holes for the screws. Make sure the distance between the centers of the holes matches what is listed in the product specifications appendix.

Note: Be careful to avoid damaging pipes or cables located inside the wall when drilling holes for the screws.

- 3 Do not screw the screws all the way into the wall. Leave a small gap of about 0.5 cm between the heads of the screws and the wall.
- 4 Make sure the screws are snugly fastened to the wall. They need to hold the weight of the ZyXEL Device with the connection cables.
- 5 Align the holes on the back of the ZyXEL Device with the screws on the wall. Hang the ZyXEL Device on the screws.

Figure 155 Wall-mounting Example

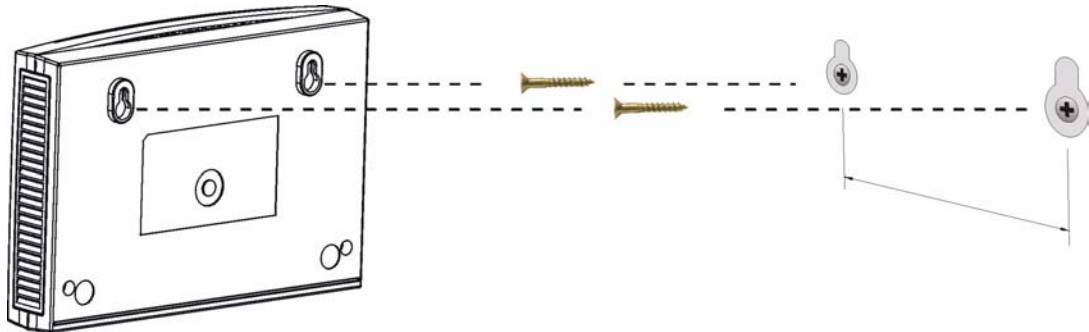

APPENDIX E

Setting up Your Computer's IP Address

All computers must have a 10M or 100M Ethernet adapter card and TCP/IP installed.

Windows 95/98/Me/NT/2000/XP, Macintosh OS 7 and later operating systems and all versions of UNIX/LINUX include the software components you need to install and use TCP/IP on your computer. Windows 3.1 requires the purchase of a third-party TCP/IP application package.

TCP/IP should already be installed on computers using Windows NT/2000/XP, Macintosh OS 7 and later operating systems.

After the appropriate TCP/IP components are installed, configure the TCP/IP settings in order to "communicate" with your network.

If you manually assign IP information instead of using dynamic assignment, make sure that your computers have IP addresses that place them in the same subnet as the ZyXEL Device's LAN port.

Windows 95/98/Me

Click **Start**, **Settings**, **Control Panel** and double-click the **Network** icon to open the **Network** window.

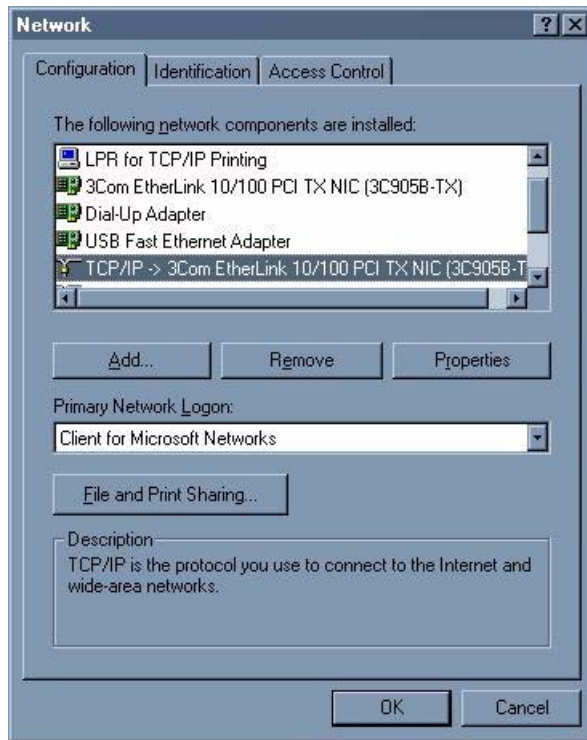
Figure 156 Windows 95/98/Me: Network: Configuration

Installing Components

The **Network** window **Configuration** tab displays a list of installed components. You need a network adapter, the TCP/IP protocol and Client for Microsoft Networks.

If you need the adapter:

- 1 In the **Network** window, click **Add**.
- 2 Select **Adapter** and then click **Add**.
- 3 Select the manufacturer and model of your network adapter and then click **OK**.

If you need TCP/IP:

- 1 In the **Network** window, click **Add**.
- 2 Select **Protocol** and then click **Add**.
- 3 Select **Microsoft** from the list of **manufacturers**.
- 4 Select **TCP/IP** from the list of network protocols and then click **OK**.

If you need Client for Microsoft Networks:

- 1 Click **Add**.
- 2 Select **Client** and then click **Add**.

- 3 Select **Microsoft** from the list of manufacturers.
- 4 Select **Client for Microsoft Networks** from the list of network clients and then click **OK**.
- 5 Restart your computer so the changes you made take effect.

Configuring

- 1 In the **Network** window **Configuration** tab, select your network adapter's TCP/IP entry and click **Properties**
- 2 Click the **IP Address** tab.
 - If your IP address is dynamic, select **Obtain an IP address automatically**.
 - If you have a static IP address, select **Specify an IP address** and type your information into the **IP Address** and **Subnet Mask** fields.

Figure 157 Windows 95/98/Me: TCP/IP Properties: IP Address

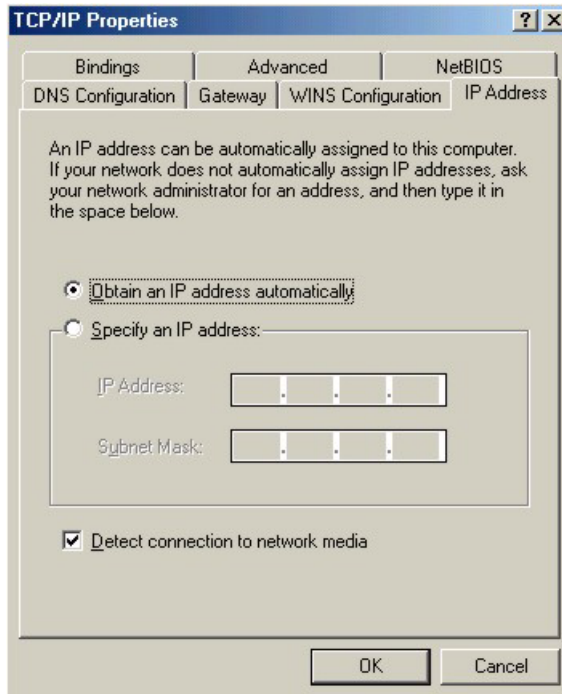

- 3 Click the **DNS Configuration** tab.
 - If you do not know your DNS information, select **Disable DNS**.
 - If you know your DNS information, select **Enable DNS** and type the information in the fields below (you may not need to fill them all in).

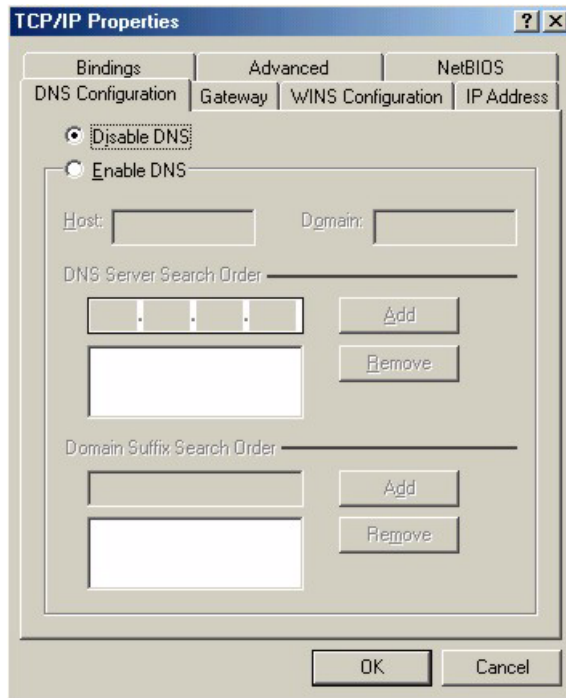
Figure 158 Windows 95/98/Me: TCP/IP Properties: DNS Configuration**4** Click the **Gateway** tab.

- If you do not know your gateway's IP address, remove previously installed gateways.
- If you have a gateway IP address, type it in the **New gateway field** and click **Add**.

5 Click **OK** to save and close the **TCP/IP Properties** window.**6** Click **OK** to close the **Network** window. Insert the Windows CD if prompted.**7** Turn on your ZyXEL Device and restart your computer when prompted.

Verifying Settings

1 Click **Start** and then **Run**.**2** In the **Run** window, type "winipcfg" and then click **OK** to open the **IP Configuration** window.**3** Select your network adapter. You should see your computer's IP address, subnet mask and default gateway.

Windows 2000/NT/XP

The following example figures use the default Windows XP GUI theme.

1 Click **start** (**Start** in Windows 2000/NT), **Settings**, **Control Panel**.

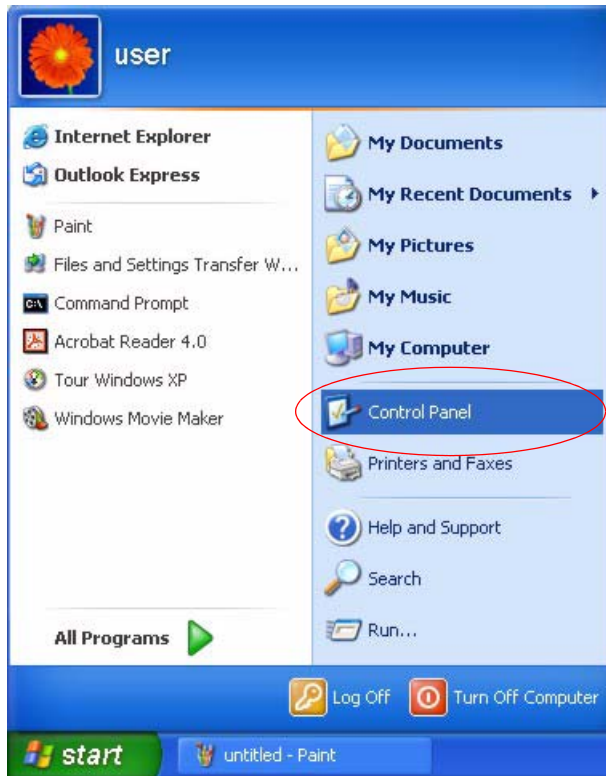
Figure 159 Windows XP: Start Menu

2 In the **Control Panel**, double-click **Network Connections (Network and Dial-up Connections)** in Windows 2000/NT).

Figure 160 Windows XP: Control Panel

3 Right-click **Local Area Connection** and then click **Properties**.

Figure 161 Windows XP: Control Panel: Network Connections: Properties

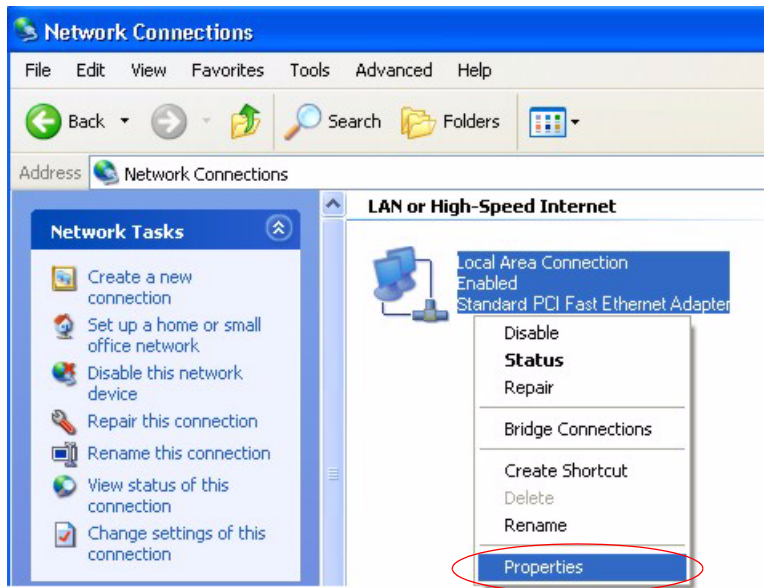

4 Select **Internet Protocol (TCP/IP)** (under the **General** tab in Win XP) and then click **Properties**.

Figure 162 Windows XP: Local Area Connection Properties

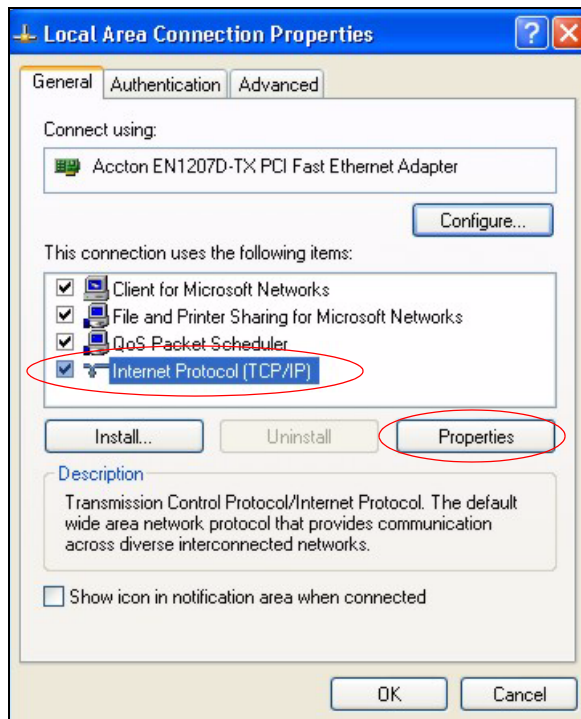

5 The **Internet Protocol TCP/IP Properties** window opens (the **General** tab in Windows XP).

- If you have a dynamic IP address click **Obtain an IP address automatically**.

- If you have a static IP address click **Use the following IP Address** and fill in the **IP address**, **Subnet mask**, and **Default gateway** fields.
- Click **Advanced**.

Figure 163 Windows XP: Internet Protocol (TCP/IP) Properties

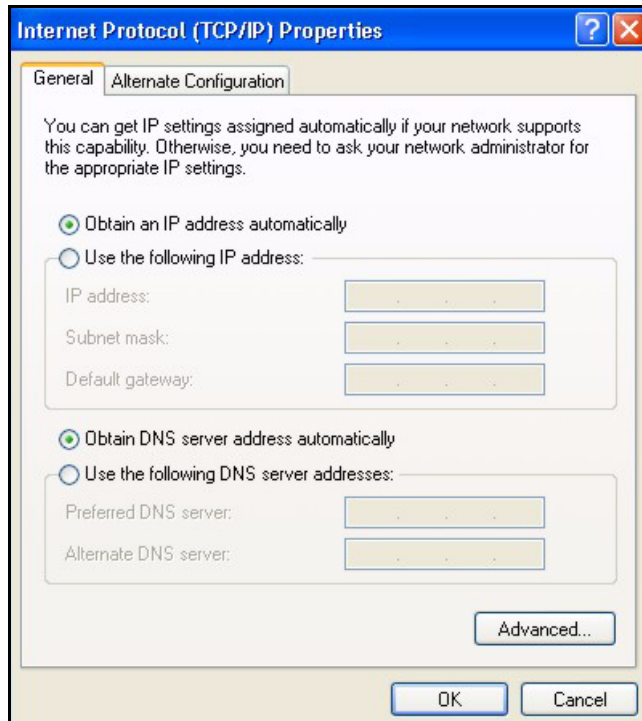

- 6 If you do not know your gateway's IP address, remove any previously installed gateways in the **IP Settings** tab and click **OK**.

Do one or more of the following if you want to configure additional IP addresses:

- In the **IP Settings** tab, in IP addresses, click **Add**.
- In **TCP/IP Address**, type an IP address in **IP address** and a subnet mask in **Subnet mask**, and then click **Add**.
- Repeat the above two steps for each IP address you want to add.
- Configure additional default gateways in the **IP Settings** tab by clicking **Add** in **Default gateways**.
- In **TCP/IP Gateway Address**, type the IP address of the default gateway in **Gateway**. To manually configure a default metric (the number of transmission hops), clear the **Automatic metric** check box and type a metric in **Metric**.
- Click **Add**.
- Repeat the previous three steps for each default gateway you want to add.
- Click **OK** when finished.

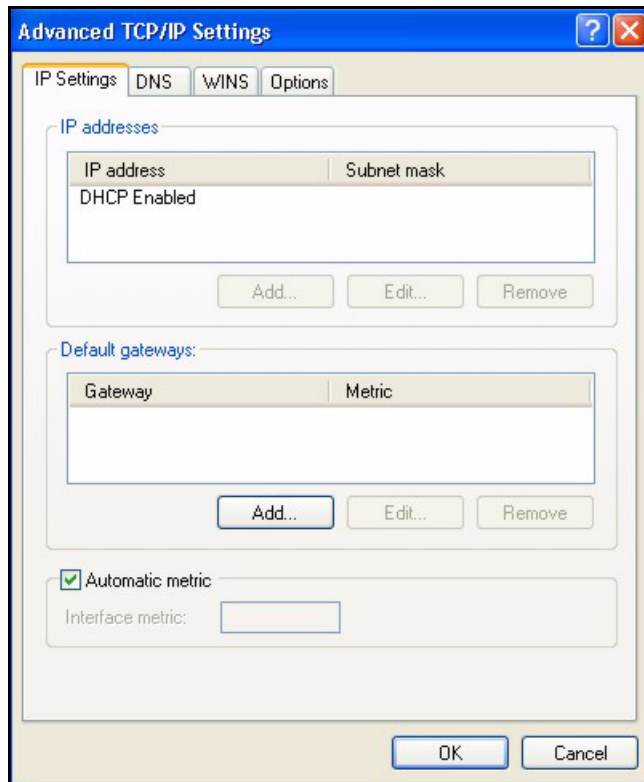
Figure 164 Windows XP: Advanced TCP/IP Properties

7 In the **Internet Protocol TCP/IP Properties** window (the **General** tab in Windows XP):

- Click **Obtain DNS server address automatically** if you do not know your DNS server IP address(es).
- If you know your DNS server IP address(es), click **Use the following DNS server addresses**, and type them in the **Preferred DNS server** and **Alternate DNS server** fields.

If you have previously configured DNS servers, click **Advanced** and then the **DNS** tab to order them.

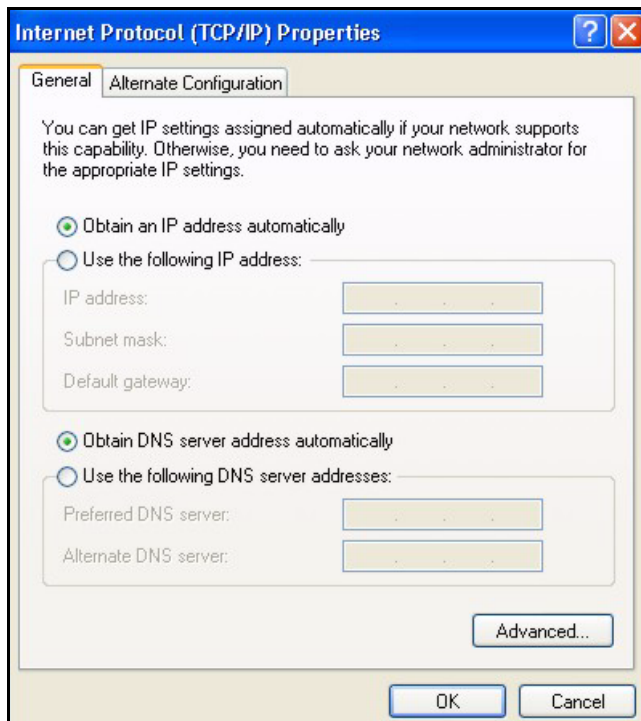
Figure 165 Windows XP: Internet Protocol (TCP/IP) Properties

- 8** Click **OK** to close the **Internet Protocol (TCP/IP) Properties** window.
- 9** Click **Close (OK in Windows 2000/NT)** to close the **Local Area Connection Properties** window.
- 10** Close the **Network Connections** window (**Network and Dial-up Connections** in Windows 2000/NT).
- 11** Turn on your ZyXEL Device and restart your computer (if prompted).

Verifying Settings

- 1** Click **Start, All Programs, Accessories** and then **Command Prompt**.
- 2** In the **Command Prompt** window, type "ipconfig" and then press [ENTER]. You can also open **Network Connections**, right-click a network connection, click **Status** and then click the **Support** tab.

Macintosh OS 8/9

- 1** Click the **Apple** menu, **Control Panel** and double-click **TCP/IP** to open the **TCP/IP Control Panel**.

Figure 166 Macintosh OS 8/9: Apple Menu

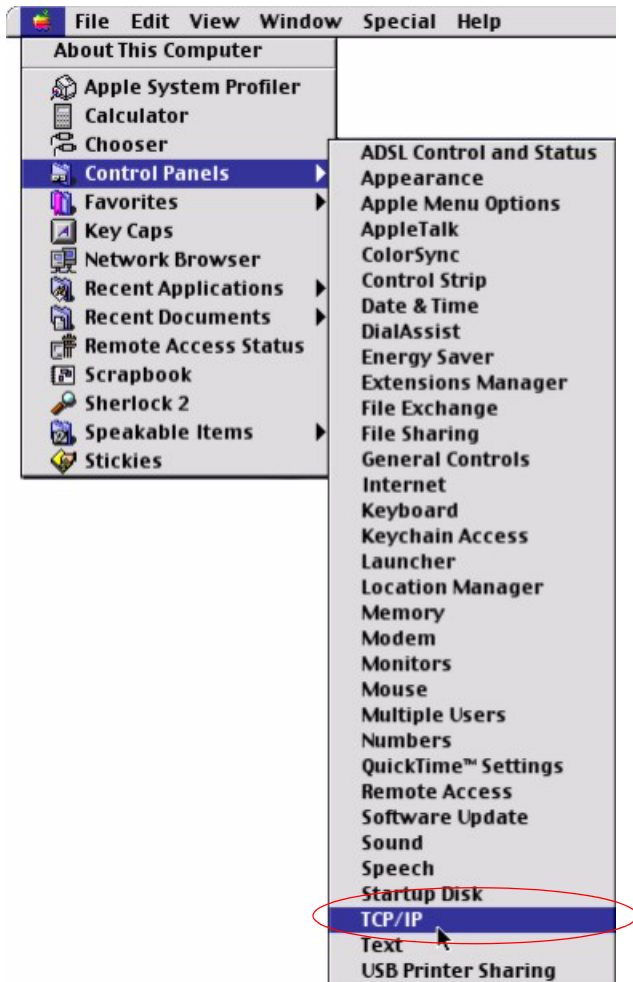

2 Select **Ethernet built-in** from the **Connect via** list.

Figure 167 Macintosh OS 8/9: TCP/IP

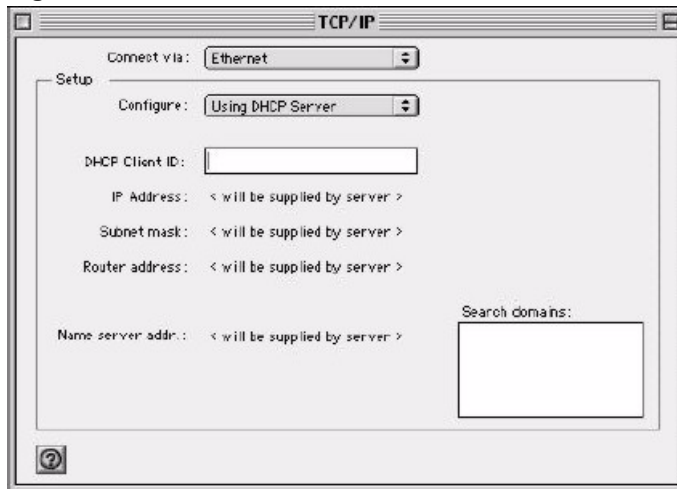

3 For dynamically assigned settings, select **Using DHCP Server** from the **Configure:** list.

- 4 For statically assigned settings, do the following:
 - From the **Configure** box, select **Manually**.
 - Type your IP address in the **IP Address** box.
 - Type your subnet mask in the **Subnet mask** box.
 - Type the IP address of your ZyXEL Device in the **Router address** box.
- 5 Close the **TCP/IP Control Panel**.
- 6 Click **Save** if prompted, to save changes to your configuration.
- 7 Turn on your ZyXEL Device and restart your computer (if prompted).

Verifying Settings

Check your TCP/IP properties in the **TCP/IP Control Panel** window.

Macintosh OS X

- 1 Click the **Apple** menu, and click **System Preferences** to open the **System Preferences** window.

Figure 168 Macintosh OS X: Apple Menu

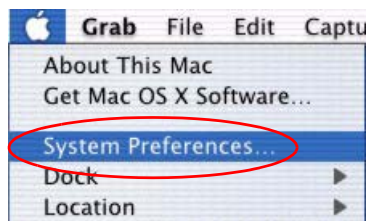

- 2 Click **Network** in the icon bar.
 - Select **Automatic** from the **Location** list.
 - Select **Built-in Ethernet** from the **Show** list.
 - Click the **TCP/IP** tab.
- 3 For dynamically assigned settings, select **Using DHCP** from the **Configure** list.

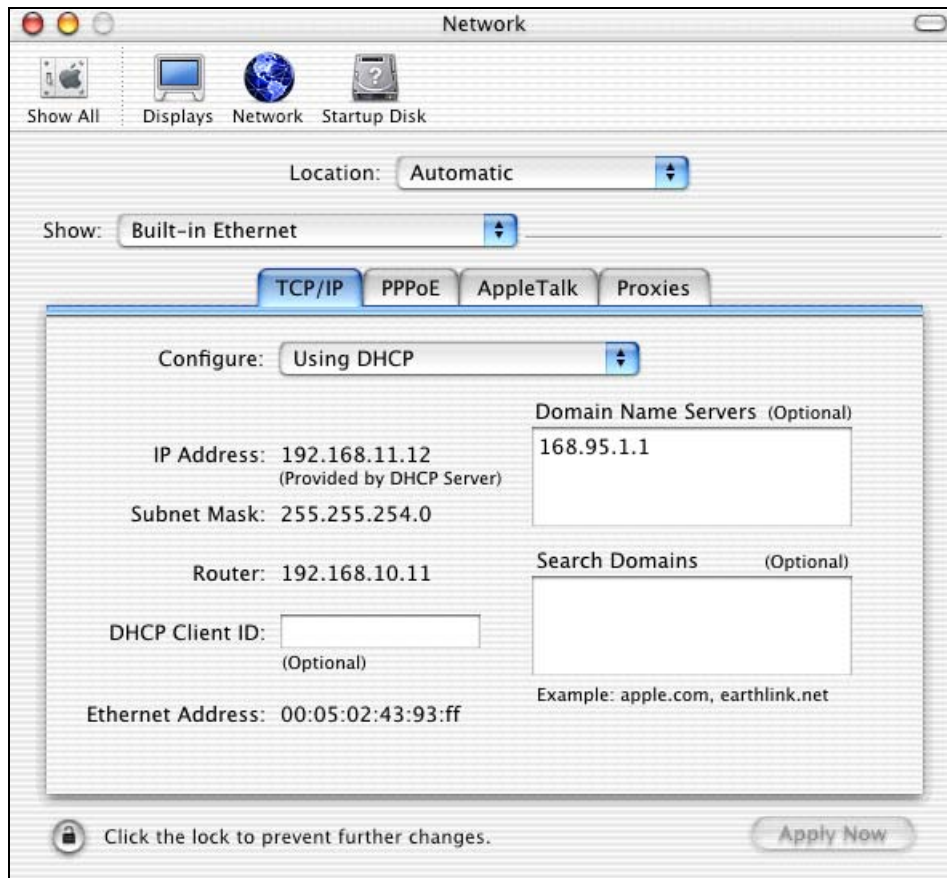
Figure 169 Macintosh OS X: Network

4 For statically assigned settings, do the following:

- From the **Configure** box, select **Manually**.
- Type your IP address in the **IP Address** box.
- Type your subnet mask in the **Subnet mask** box.
- Type the IP address of your ZyXEL Device in the **Router address** box.

5 Click **Apply Now** and close the window.

6 Turn on your ZyXEL Device and restart your computer (if prompted).

Verifying Settings

Check your TCP/IP properties in the **Network** window.

Linux

This section shows you how to configure your computer's TCP/IP settings in Red Hat Linux 9.0. Procedure, screens and file location may vary depending on your Linux distribution and release version.

Note: Make sure you are logged in as the root administrator.

Using the K Desktop Environment (KDE)

Follow the steps below to configure your computer IP address using the KDE.

- 1 Click the Red Hat button (located on the bottom left corner), select **System Setting** and click **Network**.

Figure 170 Red Hat 9.0: KDE: Network Configuration: Devices

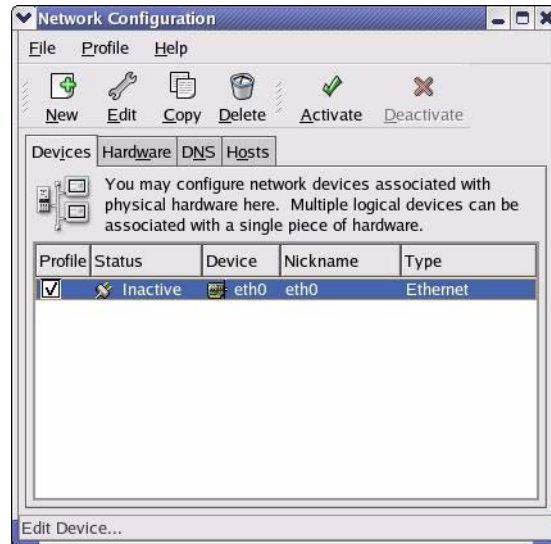

- 2 Double-click on the profile of the network card you wish to configure. The **Ethernet Device General** screen displays as shown.

Figure 171 Red Hat 9.0: KDE: Ethernet Device: General



- If you have a dynamic IP address click **Automatically obtain IP address settings with** and select **dhcp** from the drop down list.
- If you have a static IP address click **Statically set IP Addresses** and fill in the **Address**, **Subnet mask**, and **Default Gateway Address** fields.

3 Click **OK** to save the changes and close the **Ethernet Device General** screen.

4 If you know your DNS server IP address(es), click the **DNS** tab in the **Network Configuration** screen. Enter the DNS server information in the fields provided.

Figure 172 Red Hat 9.0: KDE: Network Configuration: DNS

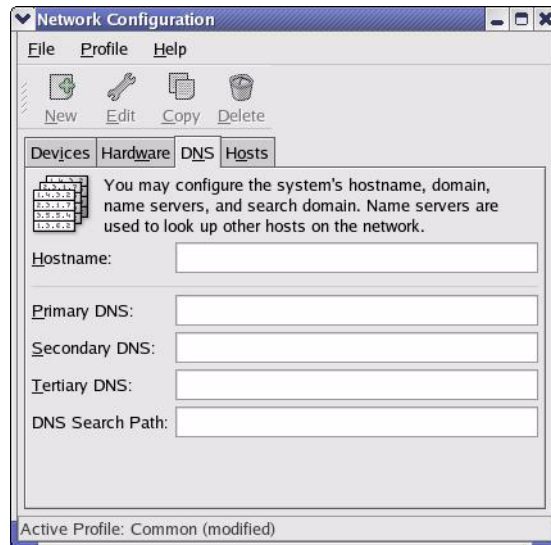

5 Click the **Devices** tab.

6 Click the **Activate** button to apply the changes. The following screen displays. Click **Yes** to save the changes in all screens.

Figure 173 Red Hat 9.0: KDE: Network Configuration: Activate

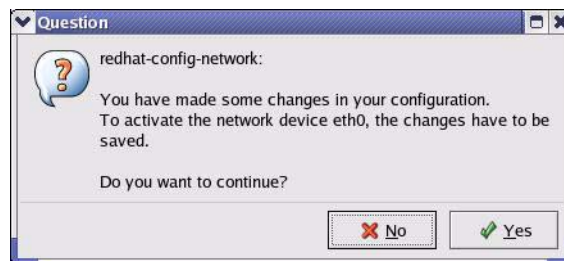

7 After the network card restart process is complete, make sure the **Status** is **Active** in the **Network Configuration** screen.

Using Configuration Files

Follow the steps below to edit the network configuration files and set your computer IP address.

- 1 Assuming that you have only one network card on the computer, locate the `ifconfig-eth0` configuration file (where `eth0` is the name of the Ethernet card). Open the configuration file with any plain text editor.
 - If you have a dynamic IP address, enter **dhcp** in the `BOOTPROTO=` field. The following figure shows an example.

Figure 174 Red Hat 9.0: Dynamic IP Address Setting in `ifconfig-eth0`

```
DEVICE=eth0
ONBOOT=yes
BOOTPROTO=dhcp
USERCTL=no
PEERDNS=yes
TYPE=Ethernet
```

- If you have a static IP address, enter **static** in the `BOOTPROTO=` field. Type `IPADDR=` followed by the IP address (in dotted decimal notation) and type `NETMASK=` followed by the subnet mask. The following example shows an example where the static IP address is 192.168.1.10 and the subnet mask is 255.255.255.0.

Figure 175 Red Hat 9.0: Static IP Address Setting in `ifconfig-eth0`

```
DEVICE=eth0
ONBOOT=yes
BOOTPROTO=static
IPADDR=192.168.1.10
NETMASK=255.255.255.0
USERCTL=no
PEERDNS=yes
TYPE=Ethernet
```

- 2 If you know your DNS server IP address(es), enter the DNS server information in the `resolv.conf` file in the `/etc` directory. The following figure shows an example where two DNS server IP addresses are specified.

Figure 176 Red Hat 9.0: DNS Settings in `resolv.conf`

```
nameserver 172.23.5.1
nameserver 172.23.5.2
```

- 3 After you edit and save the configuration files, you must restart the network card. Enter `./network restart` in the `/etc/rc.d/init.d` directory. The following figure shows an example.

Figure 177 Red Hat 9.0: Restart Ethernet Card

```
[root@localhost init.d]# network restart

Shutting down interface eth0:                [OK]
Shutting down loopback interface:           [OK]
Setting network parameters:                 [OK]
Bringing up loopback interface:             [OK]
Bringing up interface eth0:                 [OK]
```

21.4.1 Verifying Settings

Enter `ifconfig` in a terminal screen to check your TCP/IP properties.

Figure 178 Red Hat 9.0: Checking TCP/IP Properties

```
[root@localhost]# ifconfig
eth0      Link encap:Ethernet  HWaddr 00:50:BA:72:5B:44
          inet addr:172.23.19.129  Bcast:172.23.19.255  Mask:255.255.255.0
          UP BROADCAST RUNNING MULTICAST  MTU:1500  Metric:1
          RX packets:717 errors:0 dropped:0 overruns:0 frame:0
          TX packets:13 errors:0 dropped:0 overruns:0 carrier:0
          collisions:0 txqueuelen:100
          RX bytes:730412 (713.2 Kb)  TX bytes:1570 (1.5 Kb)
          Interrupt:10 Base address:0x1000
[root@localhost]#
```

APPENDIX F

IP Addresses and Subnetting

This appendix introduces IP addresses, IP address classes and subnet masks. You use subnet masks to subdivide a network into smaller logical networks.

Introduction to IP Addresses

An IP address has two parts: the network number and the host ID. Routers use the network number to send packets to the correct network, while the host ID identifies a single device on the network.

An IP address is made up of four octets, written in dotted decimal notation, for example, 192.168.1.1. (An octet is an 8-digit binary number. Therefore, each octet has a possible range of 00000000 to 11111111 in binary, or 0 to 255 in decimal.)

There are several classes of IP addresses. The first network number (192 in the above example) defines the class of IP address. These are defined as follows:

- Class A: 0 to 127
- Class B: 128 to 191
- Class C: 192 to 223
- Class D: 224 to 239
- Class E: 240 to 255

IP Address Classes and Hosts

The class of an IP address determines the number of hosts you can have on your network.

- In a class A address the first octet is the network number, and the remaining three octets are the host ID.
- In a class B address the first two octets make up the network number, and the two remaining octets make up the host ID.
- In a class C address the first three octets make up the network number, and the last octet is the host ID.

The following table shows the network number and host ID arrangement for classes A, B and C.

Table 114 Classes of IP Addresses

IP ADDRESS	OCTET 1	OCTET 2	OCTET 3	OCTET 4
Class A	Network number	Host ID	Host ID	Host ID
Class B	Network number	Network number	Host ID	Host ID
Class C	Network number	Network number	Network number	Host ID

An IP address with host IDs of all zeros is the IP address of the network (192.168.1.0 for example). An IP address with host IDs of all ones is the broadcast address for that network (192.168.1.255 for example). Therefore, to determine the total number of hosts allowed in a network, deduct two as shown next:

- A class C address (1 host octet: 8 host bits) can have $2^8 - 2$, or 254 hosts.
- A class B address (2 host octets: 16 host bits) can have $2^{16} - 2$, or 65534 hosts.

A class A address (3 host octets: 24 host bits) can have $2^{24} - 2$ hosts, or approximately 16 million hosts.

IP Address Classes and Network ID

The value of the first octet of an IP address determines the class of an address.

- Class A addresses have a **0** in the leftmost bit.
- Class B addresses have a **1** in the leftmost bit and a **0** in the next leftmost bit.
- Class C addresses start with **1 1 0** in the first three leftmost bits.
- Class D addresses begin with **1 1 1 0**. Class D addresses are used for multicasting, which is used to send information to groups of computers.
- There is also a class E. It is reserved for future use.

The following table shows the allowed ranges for the first octet of each class. This range determines the number of subnets you can have in a network.

Table 115 Allowed IP Address Range By Class

CLASS	ALLOWED RANGE OF FIRST OCTET (BINARY)	ALLOWED RANGE OF FIRST OCTET (DECIMAL)
Class A	00000000 to 01111111	0 to 127
Class B	10000000 to 10111111	128 to 191
Class C	11000000 to 11011111	192 to 223
Class D	11100000 to 11101111	224 to 239
Class E (reserved)	11110000 to 11111111	240 to 255

Subnet Masks

A subnet mask is used to determine which bits are part of the network number, and which bits are part of the host ID (using a logical AND operation).

A subnet mask has 32 bits. If a bit in the subnet mask is a “1” then the corresponding bit in the IP address is part of the network number. If a bit in the subnet mask is “0” then the corresponding bit in the IP address is part of the host ID.

Subnet masks are expressed in dotted decimal notation just like IP addresses. The “natural” masks for class A, B and C IP addresses are as follows.

Table 116 “Natural” Masks

CLASS	NATURAL MASK
A	255.0.0.0
B	255.255.0.0
C	255.255.255.0

Subnetting

With subnetting, the class arrangement of an IP address is ignored. For example, a class C address no longer has to have 24 bits of network number and 8 bits of host ID. With subnetting, some of the host ID bits are converted into network number bits.

By convention, subnet masks always consist of a continuous sequence of ones beginning from the leftmost bit of the mask, followed by a continuous sequence of zeros, for a total number of 32 bits.

Since the mask is always a continuous number of ones beginning from the left, followed by a continuous number of zeros for the remainder of the 32 bit mask, you can simply specify the number of ones instead of writing the value of each octet. This is usually specified by writing a “/” followed by the number of bits in the mask after the address.

For example, 192.1.1.0 /25 is equivalent to saying 192.1.1.0 with mask 255.255.255.128.

The following table shows all possible subnet masks for a class “C” address using both notations.

Table 117 Alternative Subnet Mask Notation

SUBNET MASK	SUBNET MASK “1” BITS	LAST OCTET BIT VALUE	DECIMAL
255.255.255.0	/24	0000 0000	0
255.255.255.128	/25	1000 0000	128
255.255.255.192	/26	1100 0000	192
255.255.255.224	/27	1110 0000	224

Table 117 Alternative Subnet Mask Notation (continued)

SUBNET MASK	SUBNET MASK "4" BITS	LAST OCTET BIT VALUE	DECIMAL
255.255.255.240	/28	1111 0000	240
255.255.255.248	/29	1111 1000	248
255.255.255.252	/30	1111 1100	252

The first mask shown is the class "C" natural mask. Normally if no mask is specified it is understood that the natural mask is being used.

Example: Two Subnets

As an example, you have a class "C" address 192.168.1.0 with subnet mask of 255.255.255.0.

Table 118 Two Subnets Example

IP/SUBNET MASK	NETWORK NUMBER	HOST ID
IP Address	192.168.1.	0
IP Address (Binary)	11000000.10101000.00000001.	00000000
Subnet Mask	255.255.255.	0
Subnet Mask (Binary)	11111111.11111111.11111111.	00000000

The first three octets of the address make up the network number (class "C").

To make two networks, divide the network 192.168.1.0 into two separate subnets by converting one of the host ID bits of the IP address to a network number bit. The "borrowed" host ID bit can be either "0" or "1" thus giving two subnets; 192.168.1.0 with mask 255.255.255.128 and 192.168.1.128 with mask 255.255.255.128.

Note: In the following charts, shaded/bolded last octet bit values indicate host ID bits "borrowed" to make network ID bits. The number of "borrowed" host ID bits determines the number of subnets you can have. The remaining number of host ID bits (after "borrowing") determines the number of hosts you can have on each subnet.

Table 119 Subnet 1

IP/SUBNET MASK	NETWORK NUMBER	LAST OCTET BIT VALUE
IP Address	192.168.1.	0
IP Address (Binary)	11000000.10101000.00000001.	00000000
Subnet Mask	255.255.255.	128
Subnet Mask (Binary)	11111111.11111111.11111111.	10000000

Table 119 Subnet 1 (continued)

IP/SUBNET MASK	NETWORK NUMBER	LAST OCTET BIT VALUE
Subnet Address: 192.168.1.0	Lowest Host ID: 192.168.1.1	
Broadcast Address: 192.168.1.127	Highest Host ID: 192.168.1.126	

Table 120 Subnet 2

IP/SUBNET MASK	NETWORK NUMBER	LAST OCTET BIT VALUE
IP Address	192.168.1.	128
IP Address (Binary)	11000000.10101000.00000001.	10000000
Subnet Mask	255.255.255.	128
Subnet Mask (Binary)	11111111.11111111.11111111.	10000000
Subnet Address: 192.168.1.128	Lowest Host ID: 192.168.1.129	
Broadcast Address: 192.168.1.255	Highest Host ID: 192.168.1.254	

Host IDs of all zeros represent the subnet itself and host IDs of all ones are the broadcast address for that subnet, so the actual number of hosts available on each subnet in the example above is $2^7 - 2$ or 126 hosts for each subnet.

192.168.1.0 with mask 255.255.255.128 is the subnet itself, and 192.168.1.127 with mask 255.255.255.128 is the directed broadcast address for the first subnet. Therefore, the lowest IP address that can be assigned to an actual host for the first subnet is 192.168.1.1 and the highest is 192.168.1.126. Similarly the host ID range for the second subnet is 192.168.1.129 to 192.168.1.254.

Example: Four Subnets

The above example illustrated using a 25-bit subnet mask to divide a class “C” address space into two subnets. Similarly to divide a class “C” address into four subnets, you need to “borrow” two host ID bits to give four possible combinations (00, 01, 10 and 11). The subnet mask is 26 bits (11111111.11111111.11111111.11000000) or 255.255.255.192. Each subnet contains 6 host ID bits, giving 2^6-2 or 62 hosts for each subnet (all zeroes is the subnet itself, all ones is the broadcast address on the subnet).

Table 121 Subnet 1

IP/SUBNET MASK	NETWORK NUMBER	LAST OCTET BIT VALUE
IP Address	192.168.1.	0
IP Address (Binary)	11000000.10101000.00000001.	00000000
Subnet Mask (Binary)	11111111.11111111.11111111.	11000000

Table 121 Subnet 1 (continued)

IP/SUBNET MASK	NETWORK NUMBER	LAST OCTET BIT VALUE
Subnet Address: 192.168.1.0	Lowest Host ID: 192.168.1.1	
Broadcast Address: 192.168.1.63	Highest Host ID: 192.168.1.62	

Table 122 Subnet 2

IP/SUBNET MASK	NETWORK NUMBER	LAST OCTET BIT VALUE
IP Address	192.168.1.	64
IP Address (Binary)	11000000.10101000.00000001.	01000000
Subnet Mask (Binary)	11111111.11111111.11111111.	11000000
Subnet Address: 192.168.1.64	Lowest Host ID: 192.168.1.65	
Broadcast Address: 192.168.1.127	Highest Host ID: 192.168.1.126	

Table 123 Subnet 3

IP/SUBNET MASK	NETWORK NUMBER	LAST OCTET BIT VALUE
IP Address	192.168.1.	128
IP Address (Binary)	11000000.10101000.00000001.	10000000
Subnet Mask (Binary)	11111111.11111111.11111111.	11000000
Subnet Address: 192.168.1.128	Lowest Host ID: 192.168.1.129	
Broadcast Address: 192.168.1.191	Highest Host ID: 192.168.1.190	

Table 124 Subnet 4

IP/SUBNET MASK	NETWORK NUMBER	LAST OCTET BIT VALUE
IP Address	192.168.1.	192
IP Address (Binary)	11000000.10101000.00000001.	11000000
Subnet Mask (Binary)	11111111.11111111.11111111.	11000000
Subnet Address: 192.168.1.192	Lowest Host ID: 192.168.1.193	
Broadcast Address: 192.168.1.255	Highest Host ID: 192.168.1.254	

Example Eight Subnets

Similarly use a 27-bit mask to create eight subnets (000, 001, 010, 011, 100, 101, 110 and 111).

The following table shows class C IP address last octet values for each subnet.

Table 125 Eight Subnets

SUBNET	SUBNET ADDRESS	FIRST ADDRESS	LAST ADDRESS	BROADCAST ADDRESS
1	0	1	30	31
2	32	33	62	63
3	64	65	94	95
4	96	97	126	127
5	128	129	158	159
6	160	161	190	191
7	192	193	222	223
8	224	225	254	255

The following table is a summary for class “C” subnet planning.

Table 126 Class C Subnet Planning

NO. “BORROWED” HOST BITS	SUBNET MASK	NO. SUBNETS	NO. HOSTS PER SUBNET
1	255.255.255.128 (/25)	2	126
2	255.255.255.192 (/26)	4	62
3	255.255.255.224 (/27)	8	30
4	255.255.255.240 (/28)	16	14
5	255.255.255.248 (/29)	32	6
6	255.255.255.252 (/30)	64	2
7	255.255.255.254 (/31)	128	1

Subnetting With Class A and Class B Networks.

For class “A” and class “B” addresses the subnet mask also determines which bits are part of the network number and which are part of the host ID.

A class “B” address has two host ID octets available for subnetting and a class “A” address has three host ID octets (see [Table 114 on page 291](#)) available for subnetting.

The following table is a summary for class "B" subnet planning.

Table 127 Class B Subnet Planning

NO. "BORROWED" HOST BITS	SUBNET MASK	NO. SUBNETS	NO. HOSTS PER SUBNET
1	255.255.128.0 (/17)	2	32766
2	255.255.192.0 (/18)	4	16382
3	255.255.224.0 (/19)	8	8190
4	255.255.240.0 (/20)	16	4094
5	255.255.248.0 (/21)	32	2046
6	255.255.252.0 (/22)	64	1022
7	255.255.254.0 (/23)	128	510
8	255.255.255.0 (/24)	256	254
9	255.255.255.128 (/25)	512	126
10	255.255.255.192 (/26)	1024	62
11	255.255.255.224 (/27)	2048	30
12	255.255.255.240 (/28)	4096	14
13	255.255.255.248 (/29)	8192	6
14	255.255.255.252 (/30)	16384	2
15	255.255.255.254 (/31)	32768	1

APPENDIX G

Command Interpreter

The following describes how to use the command interpreter. You can telnet to access the CLI (Command Line Interface) on the ZyXEL Device. See the included disk or zyxel.com for more detailed information on these commands.

Note: Use of undocumented commands or misconfiguration can damage the unit and possibly render it unusable.

Accessing the CLI

Use the following steps to telnet into your ZyXEL Device.

- 1 Connect your computer to the **ETHERNET** port on the ZyXEL Device.
- 2 Make sure your computer IP address and the ZyXEL Device IP address are on the same subnet. In Windows, click **Start** (usually in the bottom left corner), **Run** and then type `telnet 192.168.1.1` (the default ZyXEL Device IP address) and click **OK**.
- 3 A login screen displays. Enter the default admin password "1234".

Command Syntax

- The command keywords are in `courier new` font.
- Enter the command keywords exactly as shown, do not abbreviate.
- The required fields in a command are enclosed in angle brackets `<>`.
- The optional fields in a command are enclosed in square brackets `[]`.
- The `|` symbol means or.

For example,

```
sys filter netbios config <type> <on|off>
```

means that you must specify the type of netbios filter and whether to turn it on or off.

Command Usage

A list of valid commands can be found by typing `help` or `?` at the command prompt. Always type the full command. Type `exit` to log out of the CLI when finished.

APPENDIX H

Firewall Commands

The following describes the firewall commands.

Table 128 Firewall Commands

FUNCTION	COMMAND	DESCRIPTION
Firewall SetUp		
	<code>config edit firewall active <yes no></code>	This command turns the firewall on or off.
	<code>config retrieve firewall</code>	This command returns the previously saved firewall settings.
	<code>config save firewall</code>	This command saves the current firewall settings.
Display		
	<code>config display firewall</code>	This command shows the of all the firewall settings including e-mail, attack, and the sets/ rules.
	<code>config display firewall set <set #></code>	This command shows the current configuration of a set; including timeout values, name, default-permit, and etc.If you don't put use a number (#) after "set", information about all of the sets/rules appears.
	<code>config display firewall set <set #> rule <rule #></code>	This command shows the current entries of a rule in a firewall rule set.
	<code>config display firewall attack</code>	This command shows all of the attack response settings.
	<code>config display firewall e-mail</code>	This command shows all of the e-mail settings.
	<code>config display firewall?</code>	This command shows all of the available firewall sub commands.
Edit		

Table 128 Firewall Commands (continued)

FUNCTION	COMMAND	DESCRIPTION
E-mail	<code>config edit firewall e-mail mail-server <ip address of mail server></code>	This command sets the IP address to which the e-mail messages are sent.
	<code>config edit firewall e-mail return-addr <e-mail address></code>	This command sets the source e-mail address of the firewall e-mails.
	<code>config edit firewall e-mail email-to <e-mail address></code>	This command sets the e-mail address to which the firewall e-mails are sent.
	<code>config edit firewall e-mail policy <full hourly daily weekly></code>	This command sets how frequently the firewall log is sent via e-mail.
	<code>config edit firewall e-mail day <sunday monday tuesday wednesday thursday friday saturday></code>	This command sets the day on which the current firewall log is sent through e-mail if the ZyXEL Device is set to send it on a weekly basis.
	<code>config edit firewall e-mail hour <0-23></code>	This command sets the hour when the firewall log is sent through e-mail if the ZyXEL Device is set to send it on an hourly, daily or weekly basis.
	<code>config edit firewall e-mail minute <0-59></code>	This command sets the minute of the hour for the firewall log to be sent via e-mail if the ZyXEL Device is set to send it on a hourly, daily or weekly basis.
Attack	<code>config edit firewall attack send-alert <yes no></code>	This command enables or disables the immediate sending of DOS attack notification e-mail messages.
	<code>config edit firewall attack block <yes no></code>	Set this command to yes to block new traffic after the tcp-max-incomplete threshold is exceeded. Set it to no to delete the oldest half-open session when traffic exceeds the tcp-max-incomplete threshold.
	<code>config edit firewall attack block-minute <0-255></code>	This command sets the number of minutes for new sessions to be blocked when the tcp-max-incomplete threshold is reached. This command is only valid when block is set to yes.

Table 128 Firewall Commands (continued)

FUNCTION	COMMAND	DESCRIPTION
	<code>config edit firewall attack minute-high <0-255></code>	This command sets the threshold rate of new half-open sessions per minute where the ZyXEL Device starts deleting old half-opened sessions until it gets them down to the minute-low threshold.
	<code>config edit firewall attack minute-low <0-255></code>	This command sets the threshold of half-open sessions where the ZyXEL Device stops deleting half-opened sessions.
	<code>config edit firewall attack max-incomplete-high <0-255></code>	This command sets the threshold of half-open sessions where the ZyXEL Device starts deleting old half-opened sessions until it gets them down to the max incomplete low.
	<code>config edit firewall attack max-incomplete-low <0-255></code>	This command sets the threshold where the ZyXEL Device stops deleting half-opened sessions.
	<code>config edit firewall attack tcp-max-incomplete <0-255></code>	This command sets the threshold of half-open TCP sessions with the same destination where the ZyXEL Device starts dropping half-open sessions to that destination.
Sets	<code>config edit firewall set <set #> name <desired name></code>	This command sets a name to identify a specified set.
	<code>Config edit firewall set <set #> default-permit <forward block></code>	This command sets whether a packet is dropped or allowed through, when it does not meet a rule within the set.
	<code>Config edit firewall set <set #> icmp-timeout <seconds></code>	This command sets the time period to allow an ICMP session to wait for the ICMP response.
	<code>Config edit firewall set <set #> udp-idle-timeout <seconds></code>	This command sets how long a UDP connection is allowed to remain inactive before the ZyXEL Device considers the connection closed.
	<code>Config edit firewall set <set #> connection-timeout <seconds></code>	This command sets how long ZyXEL Device waits for a TCP session to be established before dropping the session.
	<code>Config edit firewall set <set #> fin-wait-timeout <seconds></code>	This command sets how long the ZyXEL Device leaves a TCP session open after the firewall detects a FIN-exchange (indicating the end of the TCP session).

Table 128 Firewall Commands (continued)

FUNCTION	COMMAND	DESCRIPTION
	Config edit firewall set <set #> tcp-idle-timeout <seconds>	This command sets how long ZyXEL Device lets an inactive TCP connection remain open before considering it closed.
	Config edit firewall set <set #> log <yes no>	This command sets whether or not the ZyXEL Device creates logs for packets that match the firewall's default rule set.
Rules	Config edit firewall set <set #> rule <rule #> permit <forward block>	This command sets whether packets that match this rule are dropped or allowed through.
	Config edit firewall set <set #> rule <rule #> active <yes no>	This command sets whether a rule is enabled or not.
	Config edit firewall set <set #> rule <rule #> protocol <integer protocol value >	This command sets the protocol specification number made in this rule for ICMP.
	Config edit firewall set <set #> rule <rule #> log <none match not-match both>	This command sets the ZyXEL Device to log traffic that matches the rule, doesn't match, both or neither.
	Config edit firewall set <set #> rule <rule #> alert <yes no>	This command sets whether or not the ZyXEL Device sends an alert e-mail when a DOS attack or a violation of a particular rule occurs.
	config edit firewall set <set #> rule <rule #> srcaddr-single <ip address>	This command sets the rule to have the ZyXEL Device check for traffic with this individual source address.
	config edit firewall set <set #> rule <rule #> srcaddr-subnet <ip address> <subnet mask>	This command sets a rule to have the ZyXEL Device check for traffic from a particular subnet (defined by IP address and subnet mask).
	config edit firewall set <set #> rule <rule #> srcaddr-range <start ip address> <end ip address>	This command sets a rule to have the ZyXEL Device check for traffic from this range of addresses.

Table 128 Firewall Commands (continued)

FUNCTION	COMMAND	DESCRIPTION
	<code>config edit firewall set <set #> rule <rule #> destaddr-single <ip address></code>	This command sets the rule to have the ZyXEL Device check for traffic with this individual destination address.
	<code>config edit firewall set <set #> rule <rule #> destaddr-subnet <ip address> <subnet mask></code>	This command sets a rule to have the ZyXEL Device check for traffic with a particular subnet destination (defined by IP address and subnet mask).
	<code>config edit firewall set <set #> rule <rule #> destaddr-range <start ip address> <end ip address></code>	This command sets a rule to have the ZyXEL Device check for traffic going to this range of addresses.
	<code>config edit firewall set <set #> rule <rule #> TCP destport-single <port #></code>	This command sets a rule to have the ZyXEL Device check for TCP traffic with this destination address. You may repeat this command to enter various, non-consecutive port numbers.
	<code>config edit firewall set <set #> rule <rule #> TCP destport-range <start port #> <end port #></code>	This command sets a rule to have the ZyXEL Device check for TCP traffic with a destination port in this range.
	<code>config edit firewall set <set #> rule <rule #> UDP destport-single <port #></code>	This command sets a rule to have the ZyXEL Device check for UDP traffic with this destination address. You may repeat this command to enter various, non-consecutive port numbers.
	<code>config edit firewall set <set #> rule <rule #> UDP destport-range <start port #> <end port #></code>	This command sets a rule to have the ZyXEL Device check for UDP traffic with a destination port in this range.
Delete		
	<code>config delete firewall e-mail</code>	This command removes all of the settings for e-mail alert.
	<code>config delete firewall attack</code>	This command resets all of the attack response settings to their defaults.
	<code>config delete firewall set <set #></code>	This command removes the specified set from the firewall configuration.

Table 128 Firewall Commands (continued)

FUNCTION	COMMAND	DESCRIPTION
	<code>config delete firewall set <set #> rule<rule #></code>	This command removes the specified rule in a firewall configuration set.

APPENDIX I

NetBIOS Filter Commands

The following describes the NetBIOS packet filter commands.

Introduction

NetBIOS (Network Basic Input/Output System) are TCP or UDP broadcast packets that enable a computer to connect to and communicate with a LAN.

For some dial-up services such as PPPoE or PPTP, NetBIOS packets cause unwanted calls.

You can configure NetBIOS filters to do the following:

- Allow or disallow the sending of NetBIOS packets from the LAN to the WAN and from the WAN to the LAN.
- Allow or disallow the sending of NetBIOS packets through VPN connections.
- Allow or disallow NetBIOS packets to initiate calls.

Display NetBIOS Filter Settings

Syntax: `sys filter netbios disp`

This command gives a read-only list of the current NetBIOS filter modes for The ZyXEL Device.

NetBIOS Display Filter Settings Command Example

```
===== NetBIOS Filter Status =====  
Between LAN and WAN: Block  
IPSec Packets: Forward  
Trigger Dial: Disabled
```

The filter types and their default settings are as follows.

Table 129 NetBIOS Filter Default Settings

NAME	DESCRIPTION	EXAMPLE
Between LAN and WAN	This field displays whether NetBIOS packets are blocked or forwarded between the LAN and the WAN.	Block
IPSec Packets	This field displays whether NetBIOS packets sent through a VPN connection are blocked or forwarded.	Forward
Trigger dial	This field displays whether NetBIOS packets are allowed to initiate calls. Disabled means that NetBIOS packets are blocked from initiating calls.	Disabled

NetBIOS Filter Configuration

Syntax: `sys filter netbios config <type> <on|off>`

where

`<type>` = Identify which NetBIOS filter (numbered 0-3) to configure.

- 0 = Between LAN and WAN
- 3 = IPSec packet pass through
- 4 = Trigger Dial

`<on|off>` = For type 0 and 1, use on to enable the filter and block NetBIOS packets. Use off to disable the filter and forward NetBIOS packets. For type 3, use on to block NetBIOS packets from being sent through a VPN connection. Use off to allow NetBIOS packets to be sent through a VPN connection. For type 4, use on to allow NetBIOS packets to initiate dial backup calls. Use off to block NetBIOS packets from initiating dial backup calls.

Example commands

`sys filter netbios config 0 on` This command blocks LAN to WAN and WAN to LAN NetBIOS packets.

`sys filter netbios config 3 on` This command blocks IPSec NetBIOS packets.

`sys filter netbios config 4 off` This command stops NetBIOS commands from initiating calls.

APPENDIX J

Splitters and Microfilters

This appendix tells you how to install a POTS splitter or a telephone microfilter.

Connecting a POTS Splitter

When you use the Full Rate (G.dmt) ADSL standard, you can use a POTS (Plain Old Telephone Service) splitter to separate the telephone and ADSL signals. This allows simultaneous Internet access and telephone service on the same line. A splitter also eliminates the destructive interference conditions caused by telephone sets.

Install the POTS splitter at the point where the telephone line enters your residence, as shown in the following figure.

Figure 179 Connecting a POTS Splitter

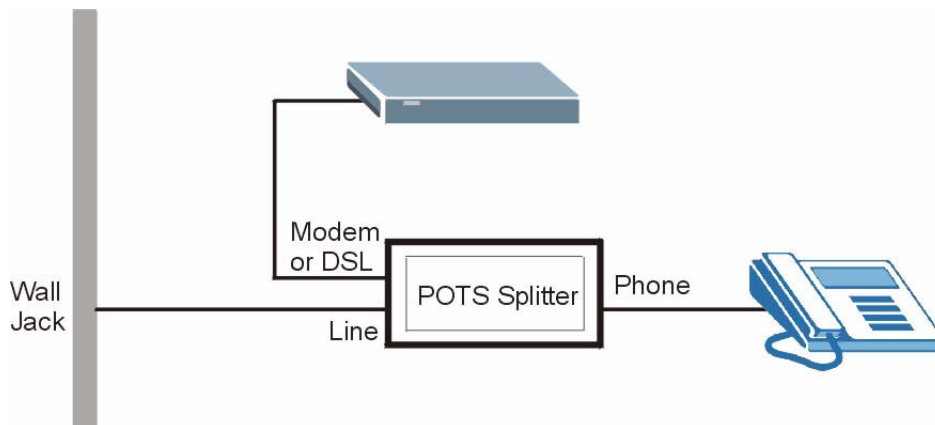

- 1 Connect the side labeled “Phone” to your telephone.
- 2 Connect the side labeled “Modem” or “DSL” to your ZyXEL Device.
- 3 Connect the side labeled “Line” to the telephone wall jack.

Telephone Microfilters

Telephone voice transmissions take place in the lower frequency range, 0 - 4KHz, while ADSL transmissions take place in the higher bandwidth range, above 4KHz. A microfilter acts as a low-pass filter, for your telephone, to ensure that ADSL transmissions do not interfere with your telephone voice transmissions. The use of a telephone microfilter is optional.

- 1 Locate and disconnect each telephone.

- 2 Connect a cable from the wall jack to the “wall side” of the microfilter.
- 3 Connect the “phone side” of the microfilter to your telephone as shown in the following figure.
- 4 After you are done, make sure that your telephone works. If your telephone does not work, disconnect the microfilter and contact either your local telephone company or the provider of the microfilter.

Figure 180 Connecting a Microfilter

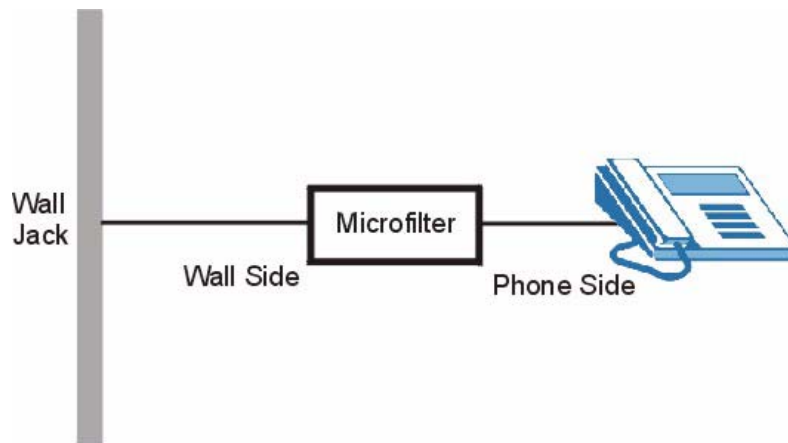

You can also use a Y-Connector with a microfilter in order to connect both your modem and a telephone to the same wall jack without using a POTS splitter.

- 1 Connect a phone cable from the wall jack to the single jack end of the Y-Connector.
- 2 Connect a cable from the double jack end of the Y-Connector to the “wall side” of the microfilter.
- 3 Connect another cable from the double jack end of the Y-Connector to the ZyXEL Device.
- 4 Connect the “phone side” of the microfilter to your telephone as shown in the following figure.

Figure 181 Connecting a Microfilter and Y-Connector

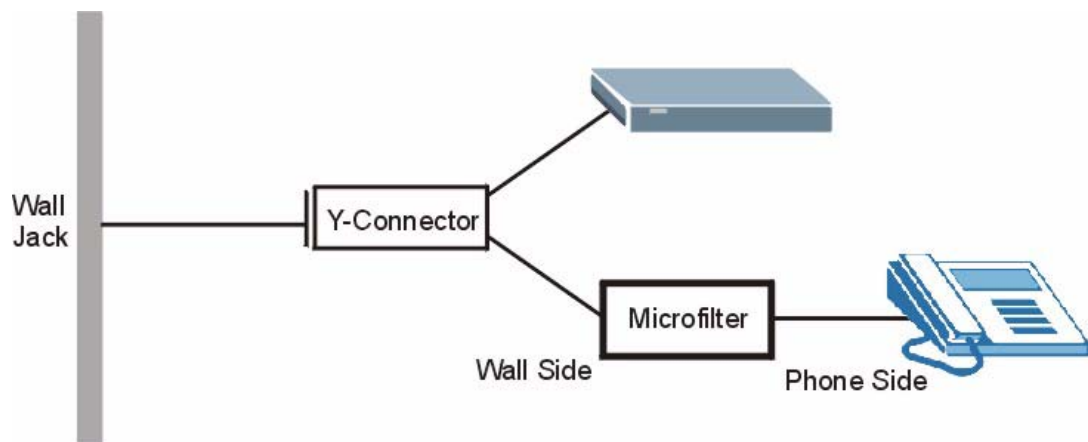

ZyXEL Device With ISDN

This section relates to people who use their ZyXEL Device with ADSL over ISDN (digital telephone service) only. The following is an example installation for the ZyXEL Device with ISDN.

Figure 182 ZyXEL Device with ISDN

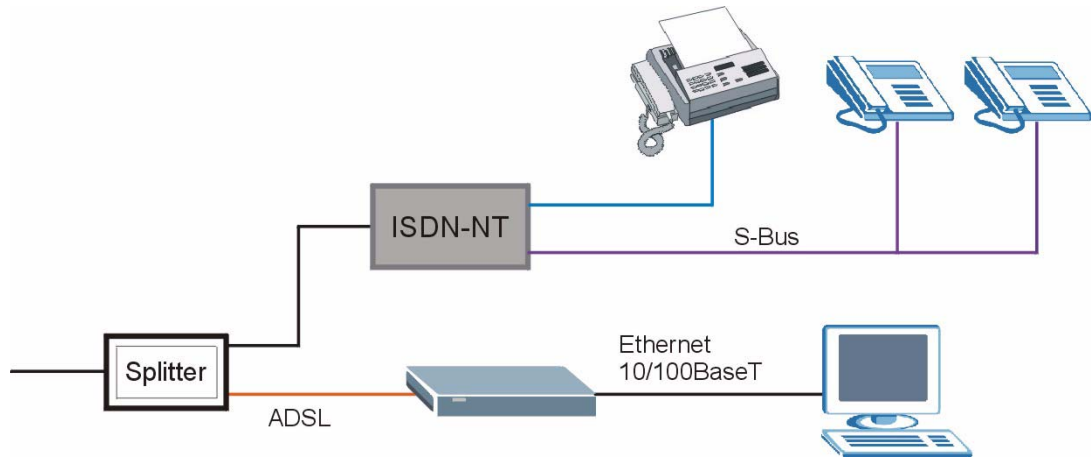

APPENDIX K

Log Descriptions

This appendix provides descriptions of example log messages.

Table 130 System Maintenance Logs

LOG MESSAGE	DESCRIPTION
Time calibration is successful	The router has adjusted its time based on information from the time server.
Time calibration failed	The router failed to get information from the time server.
WAN interface gets IP:%s	A WAN interface got a new IP address from the DHCP, PPPoE, PPTP or dial-up server.
DHCP client IP expired	A DHCP client's IP address has expired.
DHCP server assigns%s	The DHCP server assigned an IP address to a client.
Successful WEB login	Someone has logged on to the router's web configurator interface.
WEB login failed	Someone has failed to log on to the router's web configurator interface.
Successful TELNET login	Someone has logged on to the router via telnet.
TELNET login failed	Someone has failed to log on to the router via telnet.
Successful FTP login	Someone has logged on to the router via ftp.
FTP login failed	Someone has failed to log on to the router via ftp.
NAT Session Table is Full!	The maximum number of NAT session table entries has been exceeded and the table is full.
Starting Connectivity Monitor	Starting Connectivity Monitor.
Time initialized by Daytime Server	The router got the time and date from the Daytime server.
Time initialized by Time server	The router got the time and date from the time server.
Time initialized by NTP server	The router got the time and date from the NTP server.
Connect to Daytime server fail	The router was not able to connect to the Daytime server.
Connect to Time server fail	The router was not able to connect to the Time server.
Connect to NTP server fail	The router was not able to connect to the NTP server.
Too large ICMP packet has been dropped	The router dropped an ICMP packet that was too large.
Configuration Change: PC = 0x%x, Task ID = 0x%x	The router is saving configuration changes.
Successful SSH login	Someone has logged on to the router's SSH server.
SSH login failed	Someone has failed to log on to the router's SSH server.

Table 130 System Maintenance Logs (continued)

LOG MESSAGE	DESCRIPTION
Successful HTTPS login	Someone has logged on to the router's web configurator interface using HTTPS protocol.
HTTPS login failed	Someone has failed to log on to the router's web configurator interface using HTTPS protocol.

Table 131 System Error Logs

LOG MESSAGE	DESCRIPTION
%s exceeds the max. number of session per host!	This attempt to create a NAT session exceeds the maximum number of NAT session table entries allowed to be created per host.
setNetBIOSFilter: calloc error	The router failed to allocate memory for the NetBIOS filter settings.
readNetBIOSFilter: calloc error	The router failed to allocate memory for the NetBIOS filter settings.
WAN connection is down.	A WAN connection is down. You cannot access the network through this interface.

Table 132 Access Control Logs

LOG MESSAGE	DESCRIPTION
Firewall default policy: [TCP UDP IGMP ESP GRE OSPF] <Packet Direction>	Attempted TCP/UDP/IGMP/ESP/GRE/OSPF access matched the default policy and was blocked or forwarded according to the default policy's setting.
Firewall rule [NOT] match:[TCP UDP IGMP ESP GRE OSPF] <Packet Direction>, <rule:%d>	Attempted TCP/UDP/IGMP/ESP/GRE/OSPF access matched (or did not match) a configured firewall rule (denoted by its number) and was blocked or forwarded according to the rule.
Triangle route packet forwarded: [TCP UDP IGMP ESP GRE OSPF]	The firewall allowed a triangle route session to pass through.
Packet without a NAT table entry blocked: [TCP UDP IGMP ESP GRE OSPF]	The router blocked a packet that didn't have a corresponding NAT table entry.
Router sent blocked web site message: TCP	The router sent a message to notify a user that the router blocked access to a web site that the user requested.

Table 133 TCP Reset Logs

LOG MESSAGE	DESCRIPTION
Under SYN flood attack, sent TCP RST	The router sent a TCP reset packet when a host was under a SYN flood attack (the TCP incomplete count is per destination host.)
Exceed TCP MAX incomplete, sent TCP RST	The router sent a TCP reset packet when the number of TCP incomplete connections exceeded the user configured threshold. (the TCP incomplete count is per destination host.) Note: Refer to TCP Maximum Incomplete in the Firewall Attack Alerts screen.
Peer TCP state out of order, sent TCP RST	The router sent a TCP reset packet when a TCP connection state was out of order. Note: The firewall refers to RFC793 Figure 6 to check the TCP state.
Firewall session time out, sent TCP RST	The router sent a TCP reset packet when a dynamic firewall session timed out. The default timeout values are as follows: ICMP idle timeout: 3 minutes UDP idle timeout: 3 minutes TCP connection (three way handshaking) timeout: 270 seconds TCP FIN-wait timeout: 2 MSL (Maximum Segment Lifetime set in the TCP header). TCP idle (established) timeout (s): 150 minutes TCP reset timeout: 10 seconds
Exceed MAX incomplete, sent TCP RST	The router sent a TCP reset packet when the number of incomplete connections (TCP and UDP) exceeded the user-configured threshold. (Incomplete count is for all TCP and UDP connections through the firewall.) Note: When the number of incomplete connections (TCP + UDP) > "Maximum Incomplete High", the router sends TCP RST packets for TCP connections and destroys TOS (firewall dynamic sessions) until incomplete connections < "Maximum Incomplete Low".
Access block, sent TCP RST	The router sends a TCP RST packet and generates this log if you turn on the firewall TCP reset mechanism (via CLI command: "sys firewall tcprst").

Table 134 Packet Filter Logs

LOG MESSAGE	DESCRIPTION
[TCP UDP ICMP IGMP Generic] packet filter matched (set:%d, rule:%d)	Attempted access matched a configured filter rule (denoted by its set and rule number) and was blocked or forwarded according to the rule.

Table 135 ICMP Logs

LOG MESSAGE	DESCRIPTION
Firewall default policy: ICMP <Packet Direction>, <type:%d>, <code:%d>	ICMP access matched the default policy and was blocked or forwarded according to the user's setting. For type and code details, see Table 147 on page 324 .
Firewall rule [NOT] match: ICMP <Packet Direction>, <rule:%d>, <type:%d>, <code:%d>	ICMP access matched (or didn't match) a firewall rule (denoted by its number) and was blocked or forwarded according to the rule. For type and code details, see Table 147 on page 324 .
Triangle route packet forwarded: ICMP	The firewall allowed a triangle route session to pass through.
Packet without a NAT table entry blocked: ICMP	The router blocked a packet that didn't have a corresponding NAT table entry.
Unsupported/out-of-order ICMP: ICMP	The firewall does not support this kind of ICMP packets or the ICMP packets are out of order.
Router reply ICMP packet: ICMP	The router sent an ICMP reply packet to the sender.

Table 136 CDR Logs

LOG MESSAGE	DESCRIPTION
board%d line%d channel%d, call%d,%s C01 Outgoing Call dev=%x ch=%x%s	The router received the setup requirements for a call. "call" is the reference (count) number of the call. "dev" is the device type (3 is for dial-up, 6 is for PPPoE, 10 is for PPTP). "channel" or "ch" is the call channel ID. For example, "board 0 line 0 channel 0, call 3, C01 Outgoing Call dev=6 ch=0" Means the router has dialed to the PPPoE server 3 times.
board%d line%d channel%d, call%d,%s C02 OutCall Connected%d%s	The PPPoE, PPTP or dial-up call is connected.
board%d line%d channel%d, call%d,%s C02 Call Terminated	The PPPoE, PPTP or dial-up call was disconnected.

Table 137 PPP Logs

LOG MESSAGE	DESCRIPTION
ppp:LCP Starting	The PPP connection's Link Control Protocol stage has started.
ppp:LCP Opening	The PPP connection's Link Control Protocol stage is opening.
ppp:CHAP Opening	The PPP connection's Challenge Handshake Authentication Protocol stage is opening.
ppp:IPCP Starting	The PPP connection's Internet Protocol Control Protocol stage is starting.
ppp:IPCP Opening	The PPP connection's Internet Protocol Control Protocol stage is opening.

Table 137 PPP Logs (continued)

LOG MESSAGE	DESCRIPTION
ppp:LCP Closing	The PPP connection's Link Control Protocol stage is closing.
ppp:IPCP Closing	The PPP connection's Internet Protocol Control Protocol stage is closing.

Table 138 UPnP Logs

LOG MESSAGE	DESCRIPTION
UPnP pass through Firewall	UPnP packets can pass through the firewall.

Table 139 Content Filtering Logs

LOG MESSAGE	DESCRIPTION
%s: Keyword blocking	The content of a requested web page matched a user defined keyword.
%s: Not in trusted web list	The web site is not in a trusted domain, and the router blocks all traffic except trusted domain sites.
%s: Forbidden Web site	The web site is in the forbidden web site list.
%s: Contains ActiveX	The web site contains ActiveX.
%s: Contains Java applet	The web site contains a Java applet.
%s: Contains cookie	The web site contains a cookie.
%s: Proxy mode detected	The router detected proxy mode in the packet.
%s	The content filter server responded that the web site is in the blocked category list, but it did not return the category type.
%s:%s	The content filter server responded that the web site is in the blocked category list, and returned the category type.
%s (cache hit)	The system detected that the web site is in the blocked list from the local cache, but does not know the category type.
%s:%s (cache hit)	The system detected that the web site is in blocked list from the local cache, and knows the category type.
%s: Trusted Web site	The web site is in a trusted domain.
%s	When the content filter is not on according to the time schedule or you didn't select the "Block Matched Web Site" check box, the system forwards the web content.
Waiting content filter server timeout	The external content filtering server did not respond within the timeout period.
DNS resolving failed	The ZyXEL Device cannot get the IP address of the external content filtering via DNS query.
Creating socket failed	The ZyXEL Device cannot issue a query because TCP/IP socket creation failed, port:port number.

Table 139 Content Filtering Logs (continued)

LOG MESSAGE	DESCRIPTION
Connecting to content filter server fail	The connection to the external content filtering server failed.
License key is invalid	The external content filtering license key is invalid.

Table 140 Attack Logs

LOG MESSAGE	DESCRIPTION
attack [TCP UDP IGMP ESP GRE OSPF]	The firewall detected a TCP/UDP/IGMP/ESP/GRE/OSPF attack.
attack ICMP (type:%d, code:%d)	The firewall detected an ICMP attack. For type and code details, see Table 147 on page 324 .
land [TCP UDP IGMP ESP GRE OSPF]	The firewall detected a TCP/UDP/IGMP/ESP/GRE/OSPF land attack.
land ICMP (type:%d, code:%d)	The firewall detected an ICMP land attack. For type and code details, see Table 147 on page 324 .
ip spoofing - WAN [TCP UDP IGMP ESP GRE OSPF]	The firewall detected an IP spoofing attack on the WAN port.
ip spoofing - WAN ICMP (type:%d, code:%d)	The firewall detected an ICMP IP spoofing attack on the WAN port. For type and code details, see Table 147 on page 324 .
icmp echo: ICMP (type:%d, code:%d)	The firewall detected an ICMP echo attack. For type and code details, see Table 147 on page 324 .
syn flood TCP	The firewall detected a TCP syn flood attack.
ports scan TCP	The firewall detected a TCP port scan attack.
teardrop TCP	The firewall detected a TCP teardrop attack.
teardrop UDP	The firewall detected an UDP teardrop attack.
teardrop ICMP (type:%d, code:%d)	The firewall detected an ICMP teardrop attack. For type and code details, see Table 147 on page 324 .
illegal command TCP	The firewall detected a TCP illegal command attack.
NetBIOS TCP	The firewall detected a TCP NetBIOS attack.
ip spoofing - no routing entry [TCP UDP IGMP ESP GRE OSPF]	The firewall classified a packet with no source routing entry as an IP spoofing attack.
ip spoofing - no routing entry ICMP (type:%d, code:%d)	The firewall classified an ICMP packet with no source routing entry as an IP spoofing attack.
vulnerability ICMP (type:%d, code:%d)	The firewall detected an ICMP vulnerability attack. For type and code details, see Table 147 on page 324 .
traceroute ICMP (type:%d, code:%d)	The firewall detected an ICMP traceroute attack. For type and code details, see Table 147 on page 324 .

Table 141 IPsec Logs

LOG MESSAGE	DESCRIPTION
Discard REPLAY packet	The router received and discarded a packet with an incorrect sequence number.
Inbound packet authentication failed	The router received a packet that has been altered. A third party may have altered or tampered with the packet.
Receive IPsec packet, but no corresponding tunnel exists	The router dropped an inbound packet for which SPI could not find a corresponding phase 2 SA.
Rule <%d> idle time out, disconnect	The router dropped a connection that had outbound traffic and no inbound traffic for a certain time period. You can use the "ipsec timer chk_conn" CLI command to set the time period. The default value is 2 minutes.
WAN IP changed to <IP>	The router dropped all connections with the "MyIP" configured as "0.0.0.0" when the WAN IP address changed.

Table 142 IKE Logs

LOG MESSAGE	DESCRIPTION
Active connection allowed exceeded	The IKE process for a new connection failed because the limit of simultaneous phase 2 SAs has been reached.
Start Phase 2: Quick Mode	Phase 2 Quick Mode has started.
Verifying Remote ID failed:	The connection failed during IKE phase 2 because the router and the peer's Local/Remote Addresses don't match.
Verifying Local ID failed:	The connection failed during IKE phase 2 because the router and the peer's Local/Remote Addresses don't match.
IKE Packet Retransmit	The router retransmitted the last packet sent because there was no response from the peer.
Failed to send IKE Packet	An Ethernet error stopped the router from sending IKE packets.
Too many errors! Deleting SA	An SA was deleted because there were too many errors.
Phase 1 IKE SA process done	The phase 1 IKE SA process has been completed.
Duplicate requests with the same cookie	The router received multiple requests from the same peer while still processing the first IKE packet from the peer.
IKE Negotiation is in process	The router has already started negotiating with the peer for the connection, but the IKE process has not finished yet.
No proposal chosen	Phase 1 or phase 2 parameters don't match. Please check all protocols / settings. Ex. One device being configured for 3DES and the other being configured for DES causes the connection to fail.
Local / remote IPs of incoming request conflict with rule <%d>	The security gateway is set to "0.0.0.0" and the router used the peer's "Local Address" as the router's "Remote Address". This information conflicted with static rule #d; thus the connection is not allowed.

Table 142 IKE Logs (continued)

LOG MESSAGE	DESCRIPTION
Cannot resolve Secure Gateway Addr for rule <%d>	The router couldn't resolve the IP address from the domain name that was used for the secure gateway address.
Peer ID: <peer id> <My remote type> -<My local type>	The displayed ID information did not match between the two ends of the connection.
vs. My Remote <My remote> - <My remote>	The displayed ID information did not match between the two ends of the connection.
vs. My Local <My local>-<My local>	The displayed ID information did not match between the two ends of the connection.
Send <packet>	A packet was sent.
Recv <packet>	IKE uses ISAKMP to transmit data. Each ISAKMP packet contains many different types of payloads. All of them show in the LOG. Refer to RFC2408 – ISAKMP for a list of all ISAKMP payload types.
Recv <Main or Aggressive> Mode request from <IP>	The router received an IKE negotiation request from the peer address specified.
Send <Main or Aggressive> Mode request to <IP>	The router started negotiation with the peer.
Invalid IP <Peer local> / <Peer local>	The peer's "Local IP Address" is invalid.
Remote IP <Remote IP> / <Remote IP> conflicts	The security gateway is set to "0.0.0.0" and the router used the peer's "Local Address" as the router's "Remote Address". This information conflicted with static rule #d; thus the connection is not allowed.
Phase 1 ID type mismatch	This router's "Peer ID Type" is different from the peer IPsec router's "Local ID Type".
Phase 1 ID content mismatch	This router's "Peer ID Content" is different from the peer IPsec router's "Local ID Content".
No known phase 1 ID type found	The router could not find a known phase 1 ID in the connection attempt.
ID type mismatch. Local / Peer: <Local ID type/Peer ID type>	The phase 1 ID types do not match.
ID content mismatch	The phase 1 ID contents do not match.
Configured Peer ID Content: <Configured Peer ID Content>	The phase 1 ID contents do not match and the configured "Peer ID Content" is displayed.
Incoming ID Content: <Incoming Peer ID Content>	The phase 1 ID contents do not match and the incoming packet's ID content is displayed.
Unsupported local ID Type: <%d>	The phase 1 ID type is not supported by the router.
Build Phase 1 ID	The router has started to build the phase 1 ID.
Adjust TCP MSS to%d	The router automatically changed the TCP Maximum Segment Size value after establishing a tunnel.
Rule <%d> input idle time out, disconnect	The tunnel for the listed rule was dropped because there was no inbound traffic within the idle timeout period.
XAUTH succeed! Username: <Username>	The router used extended authentication to authenticate the listed username.

Table 142 IKE Logs (continued)

LOG MESSAGE	DESCRIPTION
XAUTH fail! Username: <Username>	The router was not able to use extended authentication to authenticate the listed username.
Rule[%d] Phase 1 negotiation mode mismatch	The listed rule's IKE phase 1 negotiation mode did not match between the router and the peer.
Rule [%d] Phase 1 encryption algorithm mismatch	The listed rule's IKE phase 1 encryption algorithm did not match between the router and the peer.
Rule [%d] Phase 1 authentication algorithm mismatch	The listed rule's IKE phase 1 authentication algorithm did not match between the router and the peer.
Rule [%d] Phase 1 authentication method mismatch	The listed rule's IKE phase 1 authentication method did not match between the router and the peer.
Rule [%d] Phase 1 key group mismatch	The listed rule's IKE phase 1 key group did not match between the router and the peer.
Rule [%d] Phase 2 protocol mismatch	The listed rule's IKE phase 2 protocol did not match between the router and the peer.
Rule [%d] Phase 2 encryption algorithm mismatch	The listed rule's IKE phase 2 encryption algorithm did not match between the router and the peer.
Rule [%d] Phase 2 authentication algorithm mismatch	The listed rule's IKE phase 2 authentication algorithm did not match between the router and the peer.
Rule [%d] Phase 2 encapsulation mismatch	The listed rule's IKE phase 2 encapsulation did not match between the router and the peer.
Rule [%d]> Phase 2 pfs mismatch	The listed rule's IKE phase 2 perfect forward secret (pfs) setting did not match between the router and the peer.
Rule [%d] Phase 1 ID mismatch	The listed rule's IKE phase 1 ID did not match between the router and the peer.
Rule [%d] Phase 1 hash mismatch	The listed rule's IKE phase 1 hash did not match between the router and the peer.
Rule [%d] Phase 1 preshared key mismatch	The listed rule's IKE phase 1 pre-shared key did not match between the router and the peer.
Rule [%d] Tunnel built successfully	The listed rule's IPsec tunnel has been built successfully.
Rule [%d] Peer's public key not found	The listed rule's IKE phase 1 peer's public key was not found.
Rule [%d] Verify peer's signature failed	The listed rule's IKE phase 1 verification of the peer's signature failed.
Rule [%d] Sending IKE request	IKE sent an IKE request for the listed rule.
Rule [%d] Receiving IKE request	IKE received an IKE request for the listed rule.
Swap rule to rule [%d]	The router changed to using the listed rule.
Rule [%d] Phase 1 key length mismatch	The listed rule's IKE phase 1 key length (with the AES encryption algorithm) did not match between the router and the peer.
Rule [%d] phase 1 mismatch	The listed rule's IKE phase 1 did not match between the router and the peer.

Table 142 IKE Logs (continued)

LOG MESSAGE	DESCRIPTION
Rule [%d] phase 2 mismatch	The listed rule's IKE phase 2 did not match between the router and the peer.
Rule [%d] Phase 2 key length mismatch	The listed rule's IKE phase 2 key lengths (with the AES encryption algorithm) did not match between the router and the peer.

Table 143 PKI Logs

LOG MESSAGE	DESCRIPTION
Enrollment successful	The SCEP online certificate enrollment was successful. The Destination field records the certification authority server IP address and port.
Enrollment failed	The SCEP online certificate enrollment failed. The Destination field records the certification authority server's IP address and port.
Failed to resolve <SCEP CA server url>	The SCEP online certificate enrollment failed because the certification authority server's address cannot be resolved.
Enrollment successful	The CMP online certificate enrollment was successful. The Destination field records the certification authority server's IP address and port.
Enrollment failed	The CMP online certificate enrollment failed. The Destination field records the certification authority server's IP address and port.
Failed to resolve <CMP CA server url>	The CMP online certificate enrollment failed because the certification authority server's IP address cannot be resolved.
Rcvd ca cert: <subject name>	The router received a certification authority certificate, with subject name as recorded, from the LDAP server whose IP address and port are recorded in the Source field.
Rcvd user cert: <subject name>	The router received a user certificate, with subject name as recorded, from the LDAP server whose IP address and port are recorded in the Source field.
Rcvd CRL <size>: <issuer name>	The router received a CRL (Certificate Revocation List), with size and issuer name as recorded, from the LDAP server whose IP address and port are recorded in the Source field.
Rcvd ARL <size>: <issuer name>	The router received an ARL (Authority Revocation List), with size and issuer name as recorded, from the LDAP server whose address and port are recorded in the Source field.
Failed to decode the received ca cert	The router received a corrupted certification authority certificate from the LDAP server whose address and port are recorded in the Source field.
Failed to decode the received user cert	The router received a corrupted user certificate from the LDAP server whose address and port are recorded in the Source field.
Failed to decode the received CRL	The router received a corrupted CRL (Certificate Revocation List) from the LDAP server whose address and port are recorded in the Source field.
Failed to decode the received ARL	The router received a corrupted ARL (Authority Revocation List) from the LDAP server whose address and port are recorded in the Source field.

Table 143 PKI Logs (continued)

LOG MESSAGE	DESCRIPTION
Rcvd data <size> too large! Max size allowed: <max size>	The router received directory data that was too large (the size is listed) from the LDAP server whose address and port are recorded in the Source field. The maximum size of directory data that the router allows is also recorded.
Cert trusted: <subject name>	The router has verified the path of the certificate with the listed subject name.
Due to <reason codes>, cert not trusted: <subject name>	Due to the reasons listed, the certificate with the listed subject name has not passed the path verification. The recorded reason codes are only approximate reasons for not trusting the certificate. Please see Table 144 on page 322 for the corresponding descriptions of the codes.

Table 144 Certificate Path Verification Failure Reason Codes

CODE	DESCRIPTION
1	Algorithm mismatch between the certificate and the search constraints.
2	Key usage mismatch between the certificate and the search constraints.
3	Certificate was not valid in the time interval.
4	(Not used)
5	Certificate is not valid.
6	Certificate signature was not verified correctly.
7	Certificate was revoked by a CRL.
8	Certificate was not added to the cache.
9	Certificate decoding failed.
10	Certificate was not found (anywhere).
11	Certificate chain looped (did not find trusted root).
12	Certificate contains critical extension that was not handled.
13	Certificate issuer was not valid (CA specific information missing).
14	(Not used)
15	CRL is too old.
16	CRL is not valid.
17	CRL signature was not verified correctly.
18	CRL was not found (anywhere).
19	CRL was not added to the cache.
20	CRL decoding failed.
21	CRL is not currently valid, but in the future.
22	CRL contains duplicate serial numbers.
23	Time interval is not continuous.
24	Time information not available.
25	Database method failed due to timeout.

Table 144 Certificate Path Verification Failure Reason Codes (continued)

CODE	DESCRIPTION
26	Database method failed.
27	Path was not verified.
28	Maximum path length reached.

Table 145 802.1X Logs

LOG MESSAGE	DESCRIPTION
Local User Database accepts user.	A user was authenticated by the local user database.
Local User Database reports user credential error.	A user was not authenticated by the local user database because of an incorrect user password.
Local User Database does not find user's credential.	A user was not authenticated by the local user database because the user is not listed in the local user database.
RADIUS accepts user.	A user was authenticated by the RADIUS Server.
RADIUS rejects user. Pls check RADIUS Server.	A user was not authenticated by the RADIUS Server. Please check the RADIUS Server.
Local User Database does not support authentication method.	The local user database only supports the EAP-MD5 method. A user tried to use another authentication method and was not authenticated.
User logout because of session timeout expired.	The router logged out a user whose session expired.
User logout because of user deassociation.	The router logged out a user who ended the session.
User logout because of no authentication response from user.	The router logged out a user from which there was no authentication response.
User logout because of idle timeout expired.	The router logged out a user whose idle timeout period expired.
User logout because of user request.	A user logged out.
Local User Database does not support authentication method.	A user tried to use an authentication method that the local user database does not support (it only supports EAP-MD5).
No response from RADIUS. Pls check RADIUS Server.	There is no response message from the RADIUS server, please check the RADIUS server.
Use Local User Database to authenticate user.	The local user database is operating as the authentication server.
Use RADIUS to authenticate user.	The RADIUS server is operating as the authentication server.
No Server to authenticate user.	There is no authentication server to authenticate a user.
Local User Database does not find user's credential.	A user was not authenticated by the local user database because the user is not listed in the local user database.

Table 146 ACL Setting Notes

PACKET DIRECTION	DIRECTION	DESCRIPTION
(L to W)	LAN to WAN	ACL set for packets traveling from the LAN to the WAN.
(W to L)	WAN to LAN	ACL set for packets traveling from the WAN to the LAN.
(L to L)	LAN to LAN/ ZyXEL Device	ACL set for packets traveling from the LAN to the LAN or the ZyXEL Device.
(W to W)	WAN to WAN/ ZyXEL Device	ACL set for packets traveling from the WAN to the WAN or the ZyXEL Device.

Table 147 ICMP Notes

TYPE	CODE	DESCRIPTION
0		Echo Reply
	0	Echo reply message
3		Destination Unreachable
	0	Net unreachable
	1	Host unreachable
	2	Protocol unreachable
	3	Port unreachable
	4	A packet that needed fragmentation was dropped because it was set to Don't Fragment (DF)
	5	Source route failed
4		Source Quench
	0	A gateway may discard internet datagrams if it does not have the buffer space needed to queue the datagrams for output to the next network on the route to the destination network.
5		Redirect
	0	Redirect datagrams for the Network
	1	Redirect datagrams for the Host
	2	Redirect datagrams for the Type of Service and Network
	3	Redirect datagrams for the Type of Service and Host
8		Echo
	0	Echo message
11		Time Exceeded
	0	Time to live exceeded in transit
	1	Fragment reassembly time exceeded
12		Parameter Problem
	0	Pointer indicates the error
13		Timestamp

Table 147 ICMP Notes (continued)

TYPE	CODE	DESCRIPTION
	0	Timestamp request message
14		Timestamp Reply
	0	Timestamp reply message
15		Information Request
	0	Information request message
16		Information Reply
	0	Information reply message

Table 148 Syslog Logs

LOG MESSAGE	DESCRIPTION
<Facility*8 + Severity>Mon dd hr:mm:ss hostname src="<srcIP:srcPort>" dst="<dstIP:dstPort>" msg="<msg>" note="<note>" devID="<mac address last three numbers>" cat="<category>"	"This message is sent by the system ("RAS" displays as the system name if you haven't configured one) when the router generates a syslog. The facility is defined in the web MAIN MENU->LOGS->Log Settings page. The severity is the log's syslog class. The definition of messages and notes are defined in the various log charts throughout this appendix. The "devID" is the last three characters of the MAC address of the router's LAN port. The "cat" is the same as the category in the router's logs.

The following table shows RFC-2408 ISAKMP payload types that the log displays. Please refer to the RFC for detailed information on each type.

Table 149 RFC-2408 ISAKMP Payload Types

LOG DISPLAY	PAYLOAD TYPE
SA	Security Association
PROP	Proposal
TRANS	Transform
KE	Key Exchange
ID	Identification
CER	Certificate
CER_REQ	Certificate Request
HASH	Hash
SIG	Signature
NONCE	Nonce
NOTFY	Notification
DEL	Delete
VID	Vendor ID

Log Commands

Go to the command interpreter interface.

Configuring What You Want the ZyXEL Device to Log

- 1 Use the `sys logs load` command to load the log setting buffer that allows you to configure which logs the ZyXEL Device is to record.
- 2 Use `sys logs category` to view a list of the log categories.

Figure 183 Displaying Log Categories Example

```

Copyright (c) 1994 - 2004 ZyXEL Communications Corp.
ras>?
Valid commands are:
sys          exit          ether          aux
ip           ipsec          bridge        bm
certificates cnm          8021x         radius
ras>

```

- 3 Use `sys logs category` followed by a log category to display the parameters that are available for the category.

Figure 184 Displaying Log Parameters Example

```

ras> sys logs category access
Usage: [0:none/1:log/2:alert/3:both] [0:don't show debug type/
1:show debug type]

```

- 4 Use `sys logs category` followed by a log category and a parameter to decide what to record.
Use 0 to not record logs for that category, 1 to record only logs for that category, 2 to record only alerts for that category, and 3 to record both logs and alerts for that category. Not every parameter is available with every category.
- 5 Use the `sys logs save` command to store the settings in the ZyXEL Device (you must do this in order to record logs).

Displaying Logs

- Use the `sys logs display` command to show all of the logs in the ZyXEL Device's log.
- Use the `sys logs category display` command to show the log settings for all of the log categories.

- Use the `sys logs display [log category]` command to show the logs in an individual ZyXEL Device log category.
- Use the `sys logs clear` command to erase all of the ZyXEL Device's logs.

Log Command Example

This example shows how to set the ZyXEL Device to record the access logs and alerts and then view the results.

```

ras> sys logs load
ras> sys logs category access 3
ras> sys logs save
ras> sys logs display access

```

#.time	source	destination	notes
message			
0 06/08/2004 05:58:21	172.21.4.154	224.0.1.24	ACCESS
BLOCK			
Firewall default policy: IGMP (W to W)			
1 06/08/2004 05:58:20	172.21.3.56	239.255.255.250	ACCESS
BLOCK			
Firewall default policy: IGMP (W to W)			
2 06/08/2004 05:58:20	172.21.0.2	239.255.255.254	ACCESS
BLOCK			
Firewall default policy: IGMP (W to W)			
3 06/08/2004 05:58:20	172.21.3.191	224.0.1.22	ACCESS
BLOCK			
Firewall default policy: IGMP (W to W)			
4 06/08/2004 05:58:20	172.21.0.254	224.0.0.1	ACCESS
BLOCK			
Firewall default policy: IGMP (W to W)			
5 06/08/2004 05:58:20	172.21.4.187:137	172.21.255.255:137	ACCESS
BLOCK			
Firewall default policy: UDP (W to W)			

APPENDIX L

Wireless LANs

Wireless LAN Topologies

This section discusses ad-hoc and infrastructure wireless LAN topologies.

Ad-hoc Wireless LAN Configuration

The simplest WLAN configuration is an independent (Ad-hoc) WLAN that connects a set of computers with wireless adapters (A, B, C). Any time two or more wireless adapters are within range of each other, they can set up an independent network, which is commonly referred to as an Ad-hoc network or Independent Basic Service Set (IBSS). The following diagram shows an example of notebook computers using wireless adapters to form an Ad-hoc wireless LAN.

Figure 185 Peer-to-Peer Communication in an Ad-hoc Network

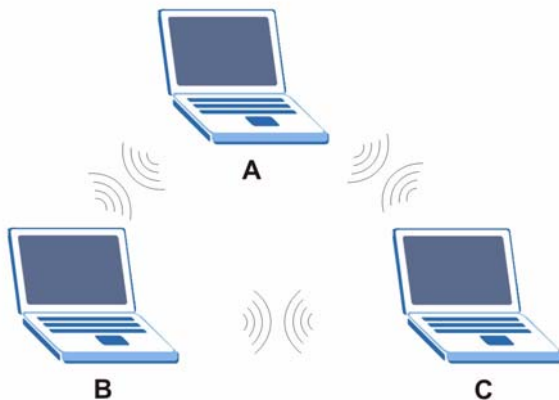

BSS

A Basic Service Set (BSS) exists when all communications between wireless clients or between a wireless client and a wired network client go through one access point (AP).

Intra-BSS traffic is traffic between wireless clients in the BSS. When Intra-BSS is enabled, wireless client **A** and **B** can access the wired network and communicate with each other. When Intra-BSS is disabled, wireless client **A** and **B** can still access the wired network but cannot communicate with each other.

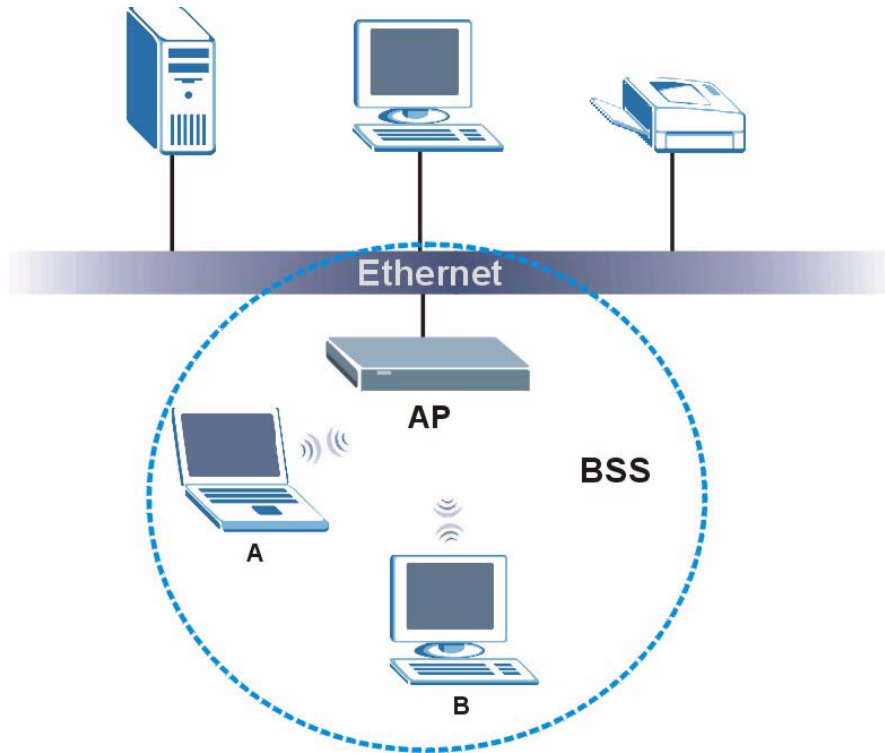
Figure 186 Basic Service Set

ESS

An Extended Service Set (ESS) consists of a series of overlapping BSSs, each containing an access point, with each access point connected together by a wired network. This wired connection between APs is called a Distribution System (DS).

This type of wireless LAN topology is called an Infrastructure WLAN. The Access Points not only provide communication with the wired network but also mediate wireless network traffic in the immediate neighborhood.

An ESSID (ESS Identification) uniquely identifies each ESS. All access points and their associated wireless clients within the same ESS must have the same ESSID in order to communicate.

Figure 187 Infrastructure WLAN

Channel

A channel is the radio frequency(ies) used by IEEE 802.11a/b/g wireless devices. Channels available depend on your geographical area. You may have a choice of channels (for your region) so you should use a different channel than an adjacent AP (access point) to reduce interference. Interference occurs when radio signals from different access points overlap causing interference and degrading performance.

Adjacent channels partially overlap however. To avoid interference due to overlap, your AP should be on a channel at least five channels away from a channel that an adjacent AP is using. For example, if your region has 11 channels and an adjacent AP is using channel 1, then you need to select a channel between 6 or 11.

RTS/CTS

A hidden node occurs when two stations are within range of the same access point, but are not within range of each other. The following figure illustrates a hidden node. Both stations (STA) are within range of the access point (AP) or wireless gateway, but out-of-range of each other, so they cannot "hear" each other, that is they do not know if the channel is currently being used. Therefore, they are considered hidden from each other.

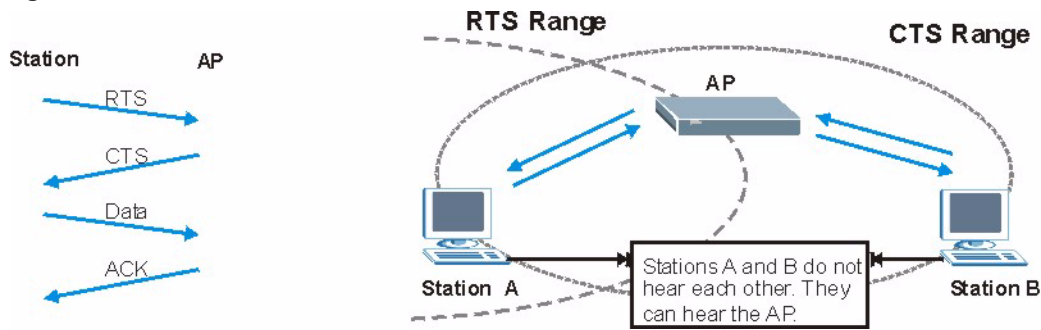
Figure 188 RTS/CTS

When station **A** sends data to the AP, it might not know that the station **B** is already using the channel. If these two stations send data at the same time, collisions may occur when both sets of data arrive at the AP at the same time, resulting in a loss of messages for both stations.

RTS/CTS is designed to prevent collisions due to hidden nodes. An **RTS/CTS** defines the biggest size data frame you can send before an RTS (Request To Send)/CTS (Clear to Send) handshake is invoked.

When a data frame exceeds the **RTS/CTS** value you set (between 0 to 2432 bytes), the station that wants to transmit this frame must first send an RTS (Request To Send) message to the AP for permission to send it. The AP then responds with a CTS (Clear to Send) message to all other stations within its range to notify them to defer their transmission. It also reserves and confirms with the requesting station the time frame for the requested transmission.

Stations can send frames smaller than the specified **RTS/CTS** directly to the AP without the RTS (Request To Send)/CTS (Clear to Send) handshake.

You should only configure **RTS/CTS** if the possibility of hidden nodes exists on your network and the "cost" of resending large frames is more than the extra network overhead involved in the RTS (Request To Send)/CTS (Clear to Send) handshake.

If the **RTS/CTS** value is greater than the **Fragmentation Threshold** value (see next), then the RTS (Request To Send)/CTS (Clear to Send) handshake will never occur as data frames will be fragmented before they reach **RTS/CTS** size.

Note: Enabling the RTS Threshold causes redundant network overhead that could negatively affect the throughput performance instead of providing a remedy.

Fragmentation Threshold

A **Fragmentation Threshold** is the maximum data fragment size (between 256 and 2432 bytes) that can be sent in the wireless network before the AP will fragment the packet into smaller data frames.

A large **Fragmentation Threshold** is recommended for networks not prone to interference while you should set a smaller threshold for busy networks or networks that are prone to interference.

If the **Fragmentation Threshold** value is smaller than the **RTS/CTS** value (see previously) you set then the RTS (Request To Send)/CTS (Clear to Send) handshake will never occur as data frames will be fragmented before they reach **RTS/CTS** size.

Preamble Type

Preamble is used to signal that data is coming to the receiver. **Short** and **Long** refer to the length of the synchronization field in a packet.

Short preamble increases performance as less time sending preamble means more time for sending data. All IEEE 802.11b/g compliant wireless adapters support long preamble, but not all support short preamble.

Select **Long** preamble if you are unsure what preamble mode the wireless adapters support, and to provide more reliable communications in busy wireless networks.

Select **Short** preamble if you are sure the wireless adapters support it, and to provide more efficient communications.

Select **Dynamic** to have the AP automatically use short preamble when wireless adapters support it, otherwise the AP uses long preamble.

Note: The AP and the wireless adapters **MUST** use the same preamble mode in order to communicate.

IEEE 802.11g Wireless LAN

IEEE 802.11g is fully compatible with the IEEE 802.11b standard. This means an IEEE 802.11b adapter can interface directly with an IEEE 802.11g access point (and vice versa) at 11 Mbps or lower depending on range. IEEE 802.11g has several intermediate rate steps between the maximum and minimum data rates. The IEEE 802.11g data rate and modulation are as follows:

Table 150 IEEE 802.11g

DATA RATE (MBPS)	MODULATION
1	DBPSK (Differential Binary Phase Shift Keyed)
2	DQPSK (Differential Quadrature Phase Shift Keying)
5.5 / 11	CCK (Complementary Code Keying)
6/9/12/18/24/36/48/54	OFDM (Orthogonal Frequency Division Multiplexing)

Wireless Security Overview

Wireless security is vital to your network to protect wireless communication between wireless clients, access points and the wired network.

Wireless security methods available on the ZyXEL Device are data encryption, wireless client authentication, restricting access by device MAC address and hiding the ZyXEL Device identity.

The following figure shows the relative effectiveness of these wireless security methods available on your ZyXEL Device.

Table 151 Wireless Security Levels

Security Level	Security Type
Least Secure	Unique SSID (Default)
	Unique SSID with Hide SSID Enabled
	MAC Address Filtering
	WEP Encryption
	IEEE802.1x EAP with RADIUS Server Authentication
Most Secure	Wi-Fi Protected Access (WPA)
	WPA2

Note: You must enable the same wireless security settings on the ZyXEL Device and on all wireless clients that you want to associate with it.

IEEE 802.1x

In June 2001, the IEEE 802.1x standard was designed to extend the features of IEEE 802.11 to support extended authentication as well as providing additional accounting and control features. It is supported by Windows XP and a number of network devices. Some advantages of IEEE 802.1x are:

- User based identification that allows for roaming.
- Support for RADIUS (Remote Authentication Dial In User Service, RFC 2138, 2139) for centralized user profile and accounting management on a network RADIUS server.
- Support for EAP (Extensible Authentication Protocol, RFC 2486) that allows additional authentication methods to be deployed with no changes to the access point or the wireless clients.

RADIUS

RADIUS is based on a client-server model that supports authentication, authorization and accounting. The access point is the client and the server is the RADIUS server. The RADIUS server handles the following tasks:

- **Authentication**
Determines the identity of the users.
- **Authorization**
Determines the network services available to authenticated users once they are connected to the network.
- **Accounting**
Keeps track of the client's network activity.

RADIUS is a simple package exchange in which your AP acts as a message relay between the wireless client and the network RADIUS server.

Types of RADIUS Messages

The following types of RADIUS messages are exchanged between the access point and the RADIUS server for user authentication:

- **Access-Request**
Sent by an access point requesting authentication.
- **Access-Reject**
Sent by a RADIUS server rejecting access.
- **Access-Accept**
Sent by a RADIUS server allowing access.
- **Access-Challenge**
Sent by a RADIUS server requesting more information in order to allow access. The access point sends a proper response from the user and then sends another Access-Request message.

The following types of RADIUS messages are exchanged between the access point and the RADIUS server for user accounting:

- **Accounting-Request**
Sent by the access point requesting accounting.
- **Accounting-Response**
Sent by the RADIUS server to indicate that it has started or stopped accounting.

In order to ensure network security, the access point and the RADIUS server use a shared secret key, which is a password, they both know. The key is not sent over the network. In addition to the shared key, password information exchanged is also encrypted to protect the network from unauthorized access.

Types of Authentication

This section discusses some popular authentication types: **EAP-MD5**, **EAP-TLS**, **EAP-TTLS**, **PEAP** and **LEAP**.

The type of authentication you use depends on the RADIUS server or the AP. Consult your network administrator for more information.

EAP-MD5 (Message-Digest Algorithm 5)

MD5 authentication is the simplest one-way authentication method. The authentication server sends a challenge to the wireless client. The wireless client 'proves' that it knows the password by encrypting the password with the challenge and sends back the information. Password is not sent in plain text.

However, MD5 authentication has some weaknesses. Since the authentication server needs to get the plaintext passwords, the passwords must be stored. Thus someone other than the authentication server may access the password file. In addition, it is possible to impersonate an authentication server as MD5 authentication method does not perform mutual authentication. Finally, MD5 authentication method does not support data encryption with dynamic session key. You must configure WEP encryption keys for data encryption.

EAP-TLS (Transport Layer Security)

With EAP-TLS, digital certifications are needed by both the server and the wireless clients for mutual authentication. The server presents a certificate to the client. After validating the identity of the server, the client sends a different certificate to the server. The exchange of certificates is done in the open before a secured tunnel is created. This makes user identity vulnerable to passive attacks. A digital certificate is an electronic ID card that authenticates the sender's identity. However, to implement EAP-TLS, you need a Certificate Authority (CA) to handle certificates, which imposes a management overhead.

EAP-TTLS (Tunneled Transport Layer Service)

EAP-TTLS is an extension of the EAP-TLS authentication that uses certificates for only the server-side authentications to establish a secure connection. Client authentication is then done by sending username and password through the secure connection, thus client identity is protected. For client authentication, EAP-TTLS supports EAP methods and legacy authentication methods such as PAP, CHAP, MS-CHAP and MS-CHAP v2.

PEAP (Protected EAP)

Like EAP-TTLS, server-side certificate authentication is used to establish a secure connection, then use simple username and password methods through the secured connection to authenticate the clients, thus hiding client identity. However, PEAP only supports EAP methods, such as EAP-MD5, EAP-MSCHAPv2 and EAP-GTC (EAP-Generic Token Card), for client authentication. EAP-GTC is implemented only by Cisco.

LEAP

LEAP (Lightweight Extensible Authentication Protocol) is a Cisco implementation of IEEE 802.1x.

Dynamic WEP Key Exchange

The AP maps a unique key that is generated with the RADIUS server. This key expires when the wireless connection times out, disconnects or reauthentication times out. A new WEP key is generated each time reauthentication is performed.

If this feature is enabled, it is not necessary to configure a default encryption key in the Wireless screen. You may still configure and store keys here, but they will not be used while Dynamic WEP is enabled.

Note: EAP-MD5 cannot be used with Dynamic WEP Key Exchange

For added security, certificate-based authentications (EAP-TLS, EAP-TTLS and PEAP) use dynamic keys for data encryption. They are often deployed in corporate environments, but for public deployment, a simple user name and password pair is more practical. The following table is a comparison of the features of authentication types.

Table 152 Comparison of EAP Authentication Types

	EAP-MD5	EAP-TLS	EAP-TTLS	PEAP	LEAP
Mutual Authentication	No	Yes	Yes	Yes	Yes
Certificate – Client	No	Yes	Optional	Optional	No
Certificate – Server	No	Yes	Yes	Yes	No
Dynamic Key Exchange	No	Yes	Yes	Yes	Yes
Credential Integrity	None	Strong	Strong	Strong	Moderate
Deployment Difficulty	Easy	Hard	Moderate	Moderate	Moderate
Client Identity Protection	No	No	Yes	Yes	No

WPA and WPA2

Wi-Fi Protected Access (WPA) is a subset of the IEEE 802.11i standard. WPA2 (IEEE 802.11i) is a wireless security standard that defines stronger encryption, authentication and key management than WPA.

Key differences between WPA or WPA2 and WEP are improved data encryption and user authentication.

If both an AP and the wireless clients support WPA2 and you have an external RADIUS server, use WPA2 for stronger data encryption. If you don't have an external RADIUS server, you should use WPA2-PSK (WPA2-Pre-Shared Key) that only requires a single (identical) password entered into each access point, wireless gateway and wireless client. As long as the passwords match, a wireless client will be granted access to a WLAN.

If the AP or the wireless clients do not support WPA2, just use WPA or WPA-PSK depending on whether you have an external RADIUS server or not.

Select WEP only when the AP and/or wireless clients do not support WPA or WPA2. WEP is less secure than WPA or WPA2.

Encryption

Both WPA and WPA2 improve data encryption by using Temporal Key Integrity Protocol (TKIP), Message Integrity Check (MIC) and IEEE 802.1x. WPA and WPA2 use Advanced Encryption Standard (AES) in the Counter mode with Cipher block chaining Message authentication code Protocol (CCMP) to offer stronger encryption than TKIP.

TKIP uses 128-bit keys that are dynamically generated and distributed by the authentication server. AES (Advanced Encryption Standard) is a block cipher that uses a 256-bit mathematical algorithm called Rijndael. They both include a per-packet key mixing function, a Message Integrity Check (MIC) named Michael, an extended initialization vector (IV) with sequencing rules, and a re-keying mechanism.

WPA and WPA2 regularly change and rotate the encryption keys so that the same encryption key is never used twice.

The RADIUS server distributes a Pairwise Master Key (PMK) key to the AP that then sets up a key hierarchy and management system, using the PMK to dynamically generate unique data encryption keys to encrypt every data packet that is wirelessly communicated between the AP and the wireless clients. This all happens in the background automatically.

The Message Integrity Check (MIC) is designed to prevent an attacker from capturing data packets, altering them and resending them. The MIC provides a strong mathematical function in which the receiver and the transmitter each compute and then compare the MIC. If they do not match, it is assumed that the data has been tampered with and the packet is dropped.

By generating unique data encryption keys for every data packet and by creating an integrity checking mechanism (MIC), with TKIP and AES it is more difficult to decrypt data on a Wi-Fi network than WEP and difficult for an intruder to break into the network.

The encryption mechanisms used for WPA(2) and WPA(2)-PSK are the same. The only difference between the two is that WPA(2)-PSK uses a simple common password, instead of user-specific credentials. The common-password approach makes WPA(2)-PSK susceptible to brute-force password-guessing attacks but it's still an improvement over WEP as it employs a consistent, single, alphanumeric password to derive a PMK which is used to generate unique temporal encryption keys. This prevent all wireless devices sharing the same encryption keys. (a weakness of WEP)

User Authentication

WPA and WPA2 apply IEEE 802.1x and Extensible Authentication Protocol (EAP) to authenticate wireless clients using an external RADIUS database. WPA2 reduces the number of key exchange messages from six to four (CCMP 4-way handshake) and shortens the time required to connect to a network. Other WPA2 authentication features that are different from WPA include key caching and pre-authentication. These two features are optional and may not be supported in all wireless devices.

Key caching allows a wireless client to store the PMK it derived through a successful authentication with an AP. The wireless client uses the PMK when it tries to connect to the same AP and does not need to go with the authentication process again.

Pre-authentication enables fast roaming by allowing the wireless client (already connecting to an AP) to perform IEEE 802.1x authentication with another AP before connecting to it.

Wireless Client WPA Supplicants

A wireless client supplicant is the software that runs on an operating system instructing the wireless client how to use WPA. At the time of writing, the most widely available supplicant is the WPA patch for Windows XP, Funk Software's Odyssey client.

The Windows XP patch is a free download that adds WPA capability to Windows XP's built-in "Zero Configuration" wireless client. However, you must run Windows XP to use it.

WPA(2) with RADIUS Application Example

You need the IP address of the RADIUS server, its port number (default is 1812), and the RADIUS shared secret. A WPA(2) application example with an external RADIUS server looks as follows. "A" is the RADIUS server. "DS" is the distribution system.

- 1 The AP passes the wireless client's authentication request to the RADIUS server.
- 2 The RADIUS server then checks the user's identification against its database and grants or denies network access accordingly.

- 3 The RADIUS server distributes a Pairwise Master Key (PMK) key to the AP that then sets up a key hierarchy and management system, using the pair-wise key to dynamically generate unique data encryption keys to encrypt every data packet that is wirelessly communicated between the AP and the wireless clients.

Figure 189 WPA(2) with RADIUS Application Example

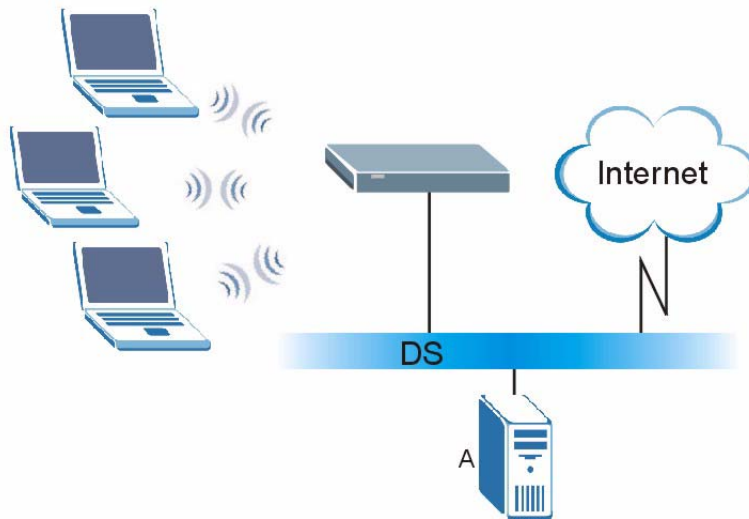

21.4.2 WPA(2)-PSK Application Example

A WPA(2)-PSK application looks as follows.

- 1 First enter identical passwords into the AP and all wireless clients. The Pre-Shared Key (PSK) must consist of between 8 and 63 ASCII characters or 64 hexadecimal characters (including spaces and symbols).
- 2 The AP checks each wireless client's password and (only) allows it to join the network if the password matches.
- 3 The AP and wireless clients use the pre-shared key to generate a common PMK (Pairwise Master Key).
- 4 The AP and wireless clients use the TKIP or AES encryption process to encrypt data exchanged between them.

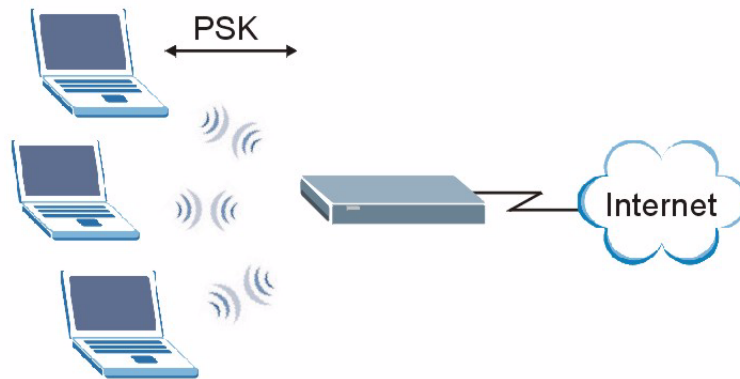
Figure 190 WPA(2)-PSK Authentication

Security Parameters Summary

Refer to this table to see what other security parameters you should configure for each Authentication Method/ key management protocol type. MAC address filters are not dependent on how you configure these security features.

Table 153 Wireless Security Relational Matrix

AUTHENTICATION METHOD/ KEY MANAGEMENT PROTOCOL	ENCRYPTION METHOD	ENTER MANUAL KEY	IEEE 802.1X
Open	None	No	Disable
			Enable without Dynamic WEP Key
Open	WEP	No	Enable with Dynamic WEP Key
		Yes	Enable without Dynamic WEP Key
		Yes	Disable
Shared	WEP	No	Enable with Dynamic WEP Key
		Yes	Enable without Dynamic WEP Key
		Yes	Disable
WPA	TKIP/AES	No	Enable
WPA-PSK	TKIP/AES	Yes	Disable
WPA2	TKIP/AES	No	Enable
WPA2-PSK	TKIP/AES	Yes	Disable

APPENDIX M

Pop-up Windows, JavaScripts and Java Permissions

In order to use the web configurator you need to allow:

- Web browser pop-up windows from your device.
- JavaScripts (enabled by default).
- Java permissions (enabled by default).

Note: Internet Explorer 6 screens are used here. Screens for other Internet Explorer versions may vary.

Internet Explorer Pop-up Blockers

You may have to disable pop-up blocking to log into your device.

Either disable pop-up blocking (enabled by default in Windows XP SP (Service Pack) 2) or allow pop-up blocking and create an exception for your device's IP address.

Disable pop-up Blockers

- 1 In Internet Explorer, select **Tools, Pop-up Blocker** and then select **Turn Off Pop-up Blocker**.

Figure 191 Pop-up Blocker

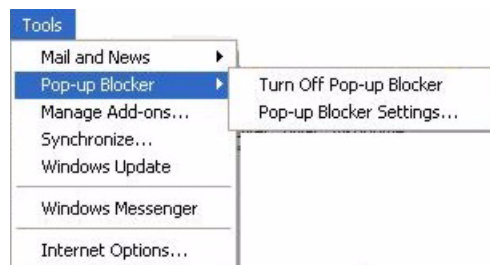

You can also check if pop-up blocking is disabled in the **Pop-up Blocker** section in the **Privacy** tab.

- 1 In Internet Explorer, select **Tools, Internet Options, Privacy**.
- 2 Clear the **Block pop-ups** check box in the **Pop-up Blocker** section of the screen. This disables any web pop-up blockers you may have enabled.

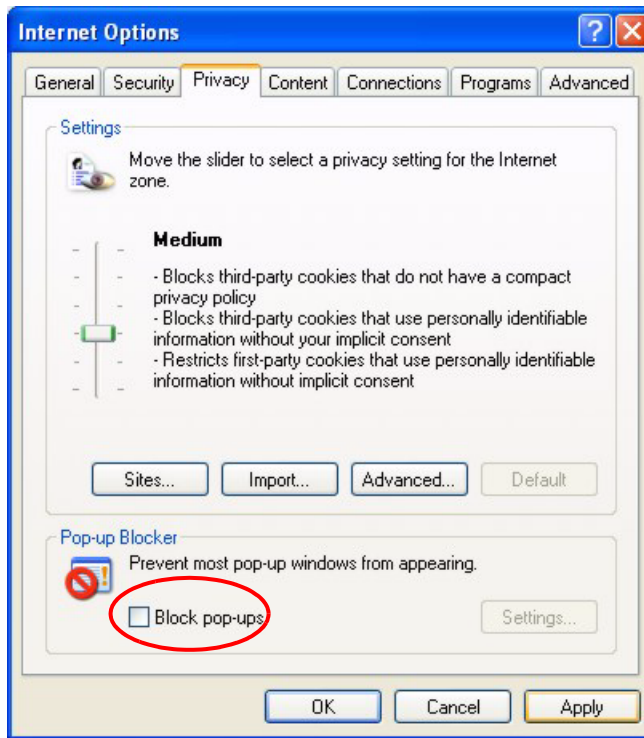
Figure 192 Internet Options

3 Click **Apply** to save this setting.

Enable pop-up Blockers with Exceptions

Alternatively, if you only want to allow pop-up windows from your device, see the following steps.

- 1** In Internet Explorer, select **Tools, Internet Options** and then the **Privacy** tab.
- 2** Select **Settings...** to open the **Pop-up Blocker Settings** screen.

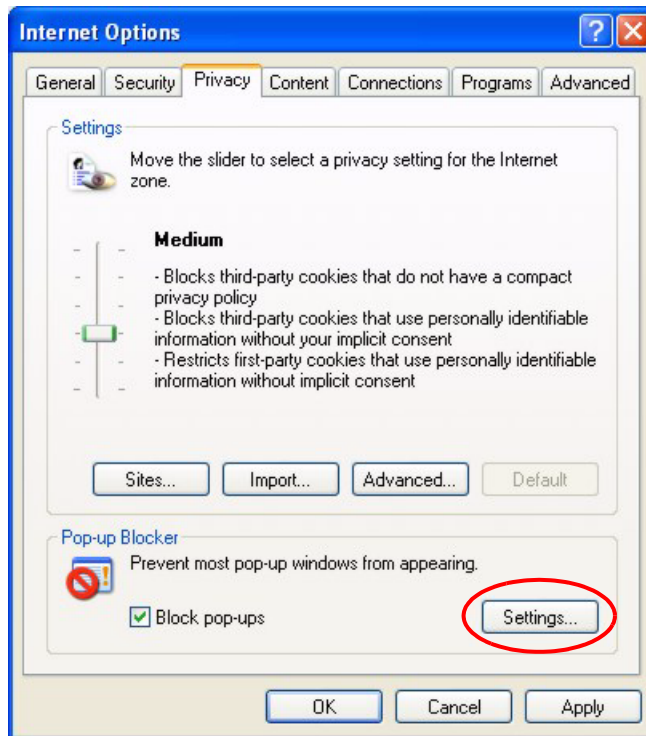
Figure 193 Internet Options

- 3** Type the IP address of your device (the web page that you do not want to have blocked) with the prefix "http://". For example, http://192.168.1.1.
- 4** Click **Add** to move the IP address to the list of **Allowed sites**.

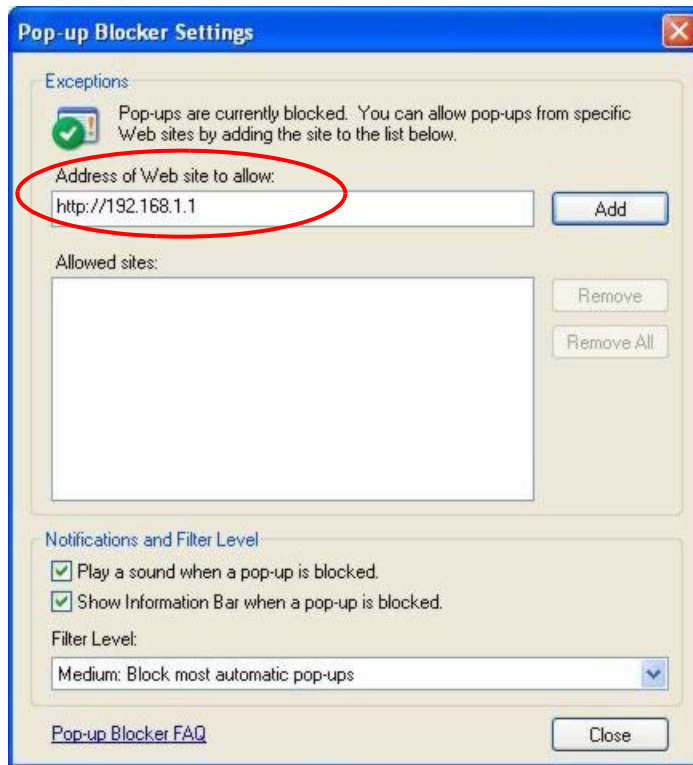
Figure 194 Pop-up Blocker Settings

5 Click **Close** to return to the **Privacy** screen.

6 Click **Apply** to save this setting.

JavaScripts

If pages of the web configurator do not display properly in Internet Explorer, check that JavaScripts are allowed.

1 In Internet Explorer, click **Tools, Internet Options** and then the **Security** tab.

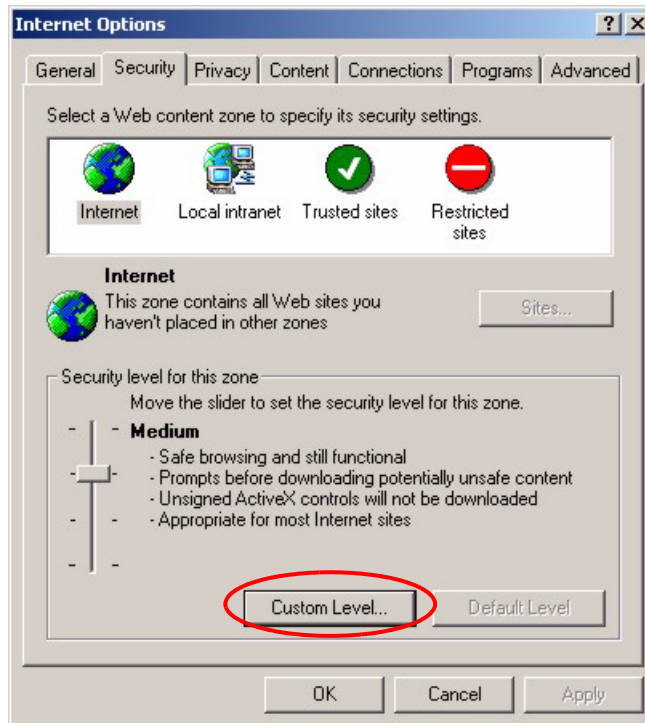
Figure 195 Internet Options

- 2** Click the **Custom Level...** button.
- 3** Scroll down to **Scripting**.
- 4** Under **Active scripting** make sure that **Enable** is selected (the default).
- 5** Under **Scripting of Java applets** make sure that **Enable** is selected (the default).
- 6** Click **OK** to close the window.

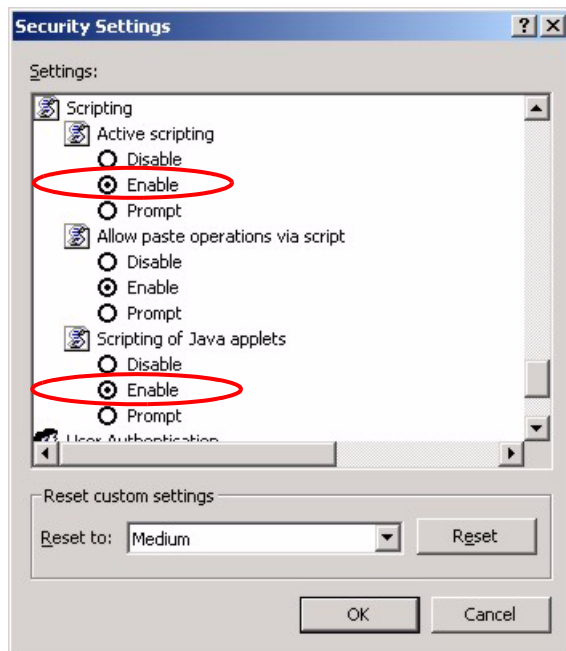
Figure 196 Security Settings - Java Scripting

Java Permissions

- 1 From Internet Explorer, click **Tools, Internet Options** and then the **Security** tab.
- 2 Click the **Custom Level...** button.
- 3 Scroll down to **Microsoft VM**.
- 4 Under **Java permissions** make sure that a safety level is selected.
- 5 Click **OK** to close the window.

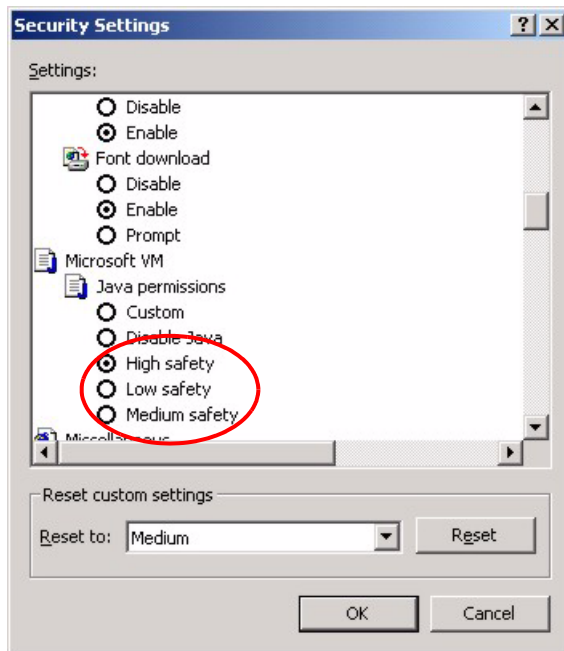
Figure 197 Security Settings - Java

JAVA (Sun)

- 1 From Internet Explorer, click **Tools, Internet Options** and then the **Advanced** tab.
- 2 make sure that **Use Java 2 for <applet>** under **Java (Sun)** is selected.
- 3 Click **OK** to close the window.

Figure 198 Java (Sun)

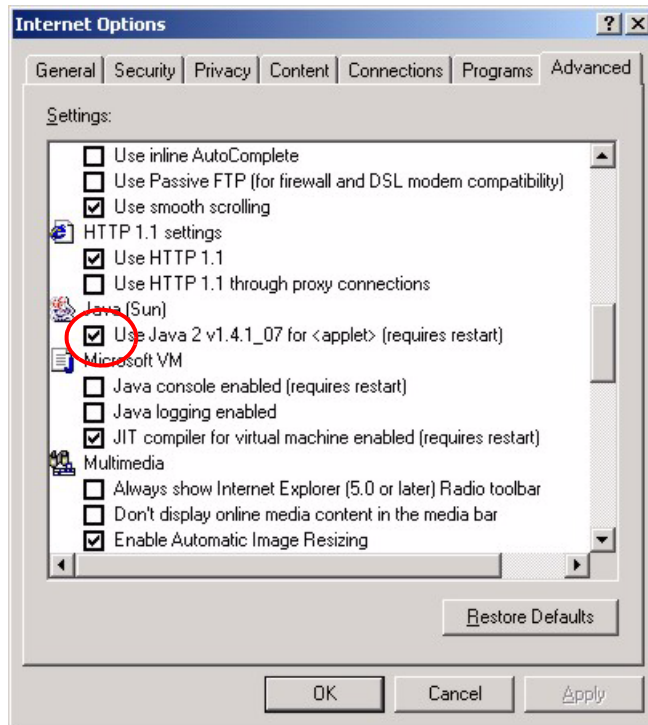

APPENDIX N

Triangle Route

The Ideal Setup

When the firewall is on, your ZyXEL Device acts as a secure gateway between your LAN and the Internet. In an ideal network topology, all incoming and outgoing network traffic passes through the ZyXEL Device to protect your LAN against attacks.

Figure 199 Ideal Setup

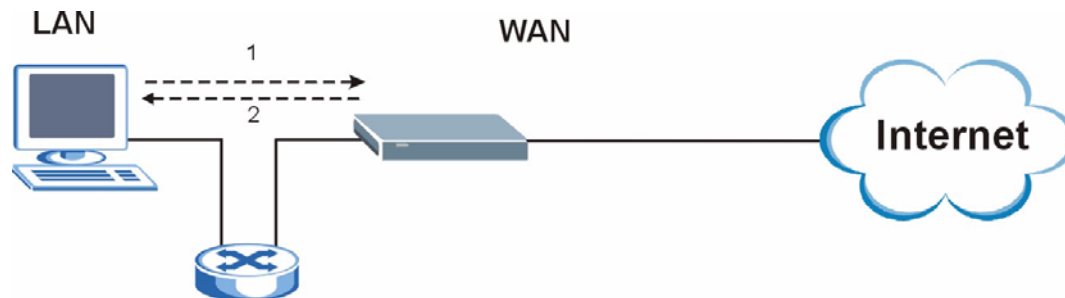

The “Triangle Route” Problem

A traffic route is a path for sending or receiving data packets between two Ethernet devices. Some companies have more than one route to one or more ISPs. If the alternate gateway is on the LAN (and its IP address is in the same subnet), the “triangle route” problem may occur. The steps below describe the “triangle route” problem.

- 1** A computer on the LAN initiates a connection by sending out a SYN packet to a receiving server on the WAN.
- 2** The ZyXEL Device reroutes the SYN packet through Gateway A on the LAN to the WAN.
- 3** The reply from the WAN goes directly to the computer on the LAN without going through the ZyXEL Device.

As a result, the ZyXEL Device resets the connection, as the connection has not been acknowledged.

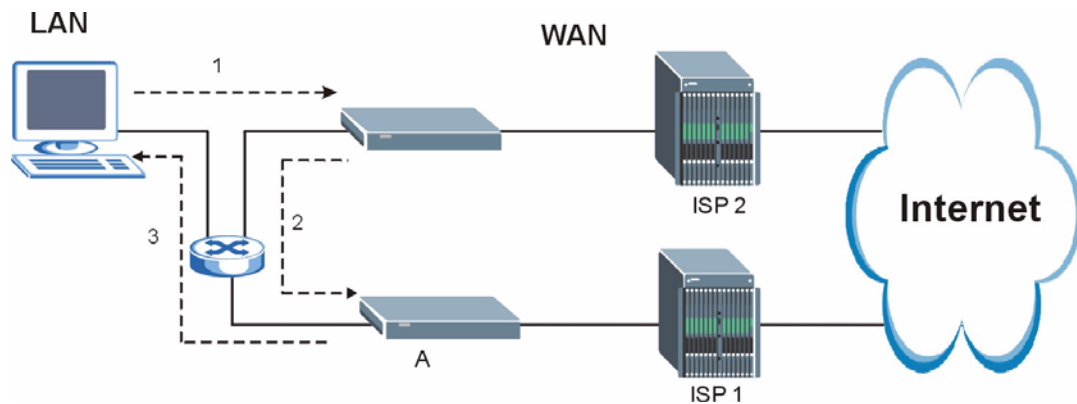
Figure 200 “Triangle Route” Problem

The “Triangle Route” Solutions

This section presents you two solutions to the “triangle route” problem.

IP Aliasing

IP alias allows you to partition your network into logical sections over the same Ethernet interface. Your ZyXEL Device supports up to three logical LAN interfaces with the ZyXEL Device being the gateway for each logical network. By putting your LAN and Gateway **B** in different subnets, all returning network traffic must pass through the ZyXEL Device to your LAN. The following steps describe such a scenario.

- 1 A computer on the LAN initiates a connection by sending a SYN packet to a receiving server on the WAN.
- 2 The ZyXEL Device reroutes the packet to Gateway **A**, which is in **Subnet 2**.
- 3 The reply from WAN goes through the ZyXEL Device to the computer on the LAN in **Subnet 1**.

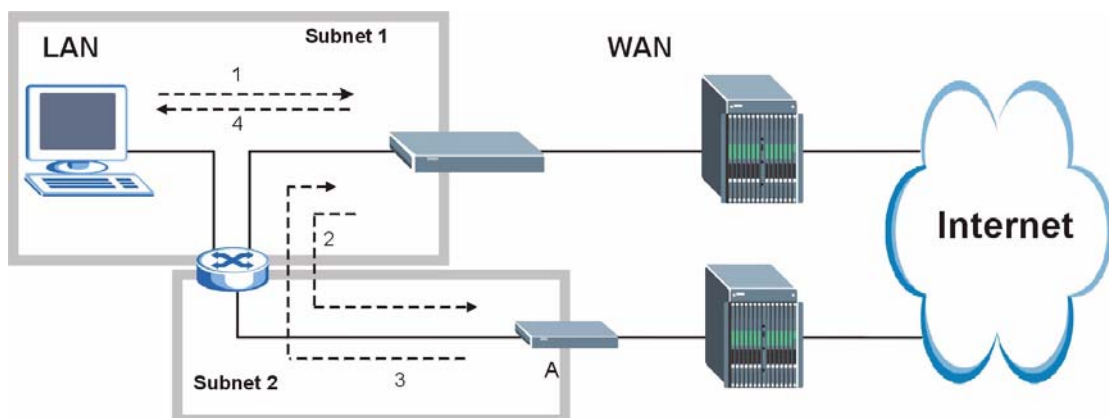
Figure 201 IP Alias

Index

A

access point [108](#)
 access point. See also AP.
 Address Assignment [96](#)
 Address Resolution Protocol (ARP) [99](#)
 ADSL standards [35](#)
 Advanced Encryption Standard [337](#)
 alternative subnet mask notation [292](#)
 Antenna gain [119](#)
 Any IP [35](#), [98](#)
 How it works [99](#)
 note [99](#)
 Any IP Setup [101](#)
 AP [108](#)
 AP (access point) [330](#)
 AP. See also access point.
 Application-level Firewalls [145](#)
 applications
 Internet access [39](#)
 ATM Adaptation Layer 5 (AAL5) [77](#)
 Attack Alert [175](#)
 Attack Types [149](#)

B

Backup [240](#)
 Backup Type [92](#)
 Bandwidth Management [186](#)
 Bandwidth Manager Class Configuration [192](#)
 Bandwidth Manager Monitor [196](#)
 Bandwidth Manager Summary [191](#)
 Basic wireless security [67](#)
 Blocking Time [174](#)
 Brute-force Attack, [148](#)
 BSS [328](#)
 BW Budget [193](#)

C

CA [335](#)

CBR (Continuous Bit Rate) [85](#), [89](#)
 Certificate Authority [335](#)
 certifications
 Notices [4](#)
 viewing [4](#)
 change password at login [43](#)
 Channel [330](#)
 Interference [330](#)
 channel [108](#)
 Channel ID [112](#)
 compact [37](#)
 compact guide [42](#)
 Configuration [95](#)
 Content Filtering [178](#)
 Categories [178](#)
 Schedule [179](#)
 Trusted computers [180](#)
 URL keyword blocking [178](#)
 Content filtering [178](#)
 content filtering [36](#)
 Copyright [2](#)
 CTS (Clear to Send) [331](#)
 Custom Ports
 Creating/Editing [166](#)
 Customer Support [8](#)
 Customized Services [165](#)
 Customized services [165](#)

D

Default [242](#)
 default LAN IP address [42](#)
 Denial of Service [145](#), [146](#), [174](#)
 Destination Address [158](#)
 device model number [238](#)
 DHCP [37](#), [95](#), [96](#), [198](#), [226](#)
 DHCP client [37](#)
 DHCP relay [37](#)
 DHCP server [37](#)
 diagnostic [244](#)
 disclaimer [2](#)
 DNS [209](#)
 Domain Name [96](#), [137](#), [226](#)
 Domain Name System [95](#)

DoS [146](#)
 Basics [146](#)
 Types [147](#)
 DoS (Denial of Service) [35](#)
 DoS attacks, types of [147](#)
 DSL (Digital Subscriber Line) [254](#)
 DSL line, reinitialize [245](#)
 DSLAM (Digital Subscriber Line Access Multiplexer) [39](#)
 Dynamic DNS [36](#), [198](#)
 dynamic DNS [36](#)
 Dynamic Host Configuration Protocol [37](#)
 Dynamic WEP Key Exchange [336](#)
 DYNDNS Wildcard [198](#)

E

EAP Authentication [335](#)
 ECHO [137](#)
 E-Mail [131](#)
 E-mail
 Log Example [236](#)
 embedded help [45](#)
 Encapsulated Routing Link Protocol (ENET ENCAP) [76](#)
 Encapsulation [76](#), [77](#)
 ENET ENCAP [76](#)
 PPP over Ethernet [76](#)
 PPPoA [77](#)
 RFC 1483 [77](#)
 Encryption [337](#)
 encryption [110](#)
 and local (user) database [111](#)
 key [111](#)
 WPA compatible [111](#)
 ESS [329](#)
 Ethernet [251](#)
 Extended Service Set [329](#)
 Extended Service Set IDentification [112](#)
 Extended wireless security [66](#)

F

Fairness-based Scheduler [188](#)
 FCC interference statement [3](#)
 Federal Communications Commission [3](#)
 Finger [137](#)
 Firewall
 Access Methods [156](#)
 Address Type [164](#)

Alerts [159](#)
 Anti-Probing [172](#)
 Creating/Editing Rules [162](#)
 Custom Ports [165](#)
 Enabling [159](#)
 Firewall Vs Filters [154](#)
 Guidelines For Enhancing Security [153](#)
 Introduction [145](#)
 LAN to WAN Rules [159](#)
 Policies [156](#)
 Rule Checklist [157](#)
 Rule Logic [157](#)
 Rule Security Ramifications [157](#)
 Services [170](#)
 Types [144](#)
 When To Use [155](#)
 firmware [238](#)
 upgrade [238](#)
 upload [238](#)
 upload error [239](#)

Fragmentation Threshold [331](#)
 Fragmentation threshold [331](#)
 FTP [136](#), [137](#), [202](#), [205](#)
 FTP Restrictions [202](#)
 Full Rate [308](#)

G

General Setup [226](#)
 General wireless LAN screen [112](#)

H

Half-Open Sessions [174](#)
 Hidden node [330](#)
 hide SSID [109](#)
 Host [227](#), [228](#)
 HTTP [137](#), [145](#), [146](#), [147](#)
 HTTP (Hypertext Transfer Protocol) [238](#)

I

IANA [97](#)
 IANA (Internet Assigned Number Authority) [165](#)
 IBSS [328](#)
 ICMP echo [148](#)
 IEEE 802.11g [37](#), [332](#)

IEEE 802.11i [38](#)
 IGMP [98](#)
 Independent Basic Service Set [328](#)
 initialization vector (IV) [337](#)
 Install UPnP [216](#)
 Windows Me [216](#)
 Windows XP [218](#)
 Integrated Services Digital Network [34](#)
 Internal SPTGEN [256](#)
 FTP Upload Example [258](#)
 Points to Remember [257](#)
 Text File [256](#)
 Internet Access [35](#), [39](#)
 Internet access [56](#)
 Internet Access Setup [247](#)
 Internet access wizard setup [56](#)
 Internet Assigned Numbers AuthoritySee IANA [97](#)
 Internet Control Message Protocol (ICMP) [148](#), [172](#)
 IP Address [96](#), [137](#), [138](#), [139](#)
 IP Address Assignment [78](#)
 ENET ENCAP [79](#)
 PPPoA or PPPoE [78](#)
 RFC 1483 [78](#)
 IP alias [37](#)
 IP Pool [102](#)
 IP Pool Setup [95](#)
 IP protocol type [170](#)
 IP Spoofing [147](#), [150](#)
 ISDN (Integrated Services Digital Network) [34](#)

K

Key Fields For Configuring Rules [158](#)

L

LAN Setup [76](#), [94](#)
 LAN TCP/IP [96](#)
 LAN to WAN Rules [159](#)
 LAND [147](#), [148](#)
 local (user) database [110](#)
 and encryption [111](#)
 Logs [232](#)

M

MAC address [109](#)
 MAC address filter [109](#)
 MAC Address Filter Action [125](#)
 MAC Address Filtering [124](#)
 MAC Filter [124](#)
 Management Information Base (MIB) [207](#)
 Maximize Bandwidth Usage [188](#)
 Maximum Burst Size (MBS) [80](#), [85](#), [90](#)
 Max-incomplete High [174](#)
 Max-incomplete Low [174](#)
 Media Bandwidth Management [36](#)
 Message Integrity Check (MIC) [337](#)
 Metric [79](#)
 Multicast [98](#)
 Multiplexing [77](#)
 multiplexing [77](#)
 LLC-based [77](#)
 VC-based [77](#)
 Multiprotocol Encapsulation [77](#)

N

Nailed-Up Connection [79](#)
 NAT [96](#), [137](#), [138](#)
 Address mapping rule [142](#)
 Application [134](#)
 Definitions [132](#)
 How it works [133](#)
 Mapping Types [134](#)
 What it does [133](#)
 What NAT does [133](#)
 NAT (Network Address Translation) [132](#)
 NAT mode [136](#)
 NAT Traversal [214](#)
 navigating the web configurator [44](#)
 NetBIOS commands [149](#)
 Network Address Translation (NAT) [36](#)
 Network Management [137](#)
 NNTP [137](#)

O

One-Minute High [174](#)

P

Packet Filtering [154](#)
Packet filtering
 When to use [155](#)
Packet Filtering Firewalls [144](#)
Pairwise Master Key (PMK) [337](#), [339](#)
Peak Cell Rate (PCR) [80](#), [85](#), [90](#)
Ping of Death [147](#)
Point to Point Protocol over ATM Adaptation Layer 5 (AAL5) [77](#)
Point-to-Point [254](#)
Point-to-Point Tunneling Protocol [137](#)
POP3 [137](#), [146](#), [147](#)
PPPoA [78](#)
PPPoE [76](#)
 Benefits [76](#)
PPPoE (Point-to-Point Protocol over Ethernet) [36](#)
PPTP [137](#)
Preamble Mode [332](#)
Priorities [126](#), [190](#)
Priority [193](#)
Priority-based Scheduler [187](#)
product registration [7](#)

Q

QoS [111](#)
 benefits [111](#)
Quick Start Guide [32](#)

R

RADIUS [334](#)
 Shared Secret Key [335](#)
RADIUS Message Types [334](#)
RADIUS Messages [334](#)
RADIUS server [110](#)
registration
 product [7](#)
reinitialize the ADSL line [245](#)
Related Documentation [32](#)
Remote Management and NAT [203](#)
Remote Management Limitations [202](#)
Reset button, the [44](#)
Resetting the ZyXEL device [44](#)
Restore [241](#)

RF (Radio Frequency) [37](#)
RFC 1483 [77](#)
RFC 1631 [132](#)
RFC-1483 [78](#)
RFC-2364 [78](#)
RFC2516 [36](#)
RIPSee Routing Information Protocol [97](#)
Routing Information Protocol [97](#)
 Direction [97](#)
 Version [97](#)
RTS (Request To Send) [331](#)
RTS Threshold [330](#), [331](#)
Rules [159](#)
 Checklist [157](#)
 Key Fields [158](#)
 LAN to WAN [159](#)
 Logic [157](#)
 Predefined Services [170](#)

S

Safety Warnings [5](#)
Saving the State [150](#)
Scheduler [187](#)
Security In General [153](#)
Security Parameters [340](#)
Security Ramifications [157](#)
Server [134](#), [135](#), [229](#)
Service [158](#)
Service Set [112](#)
Service Set IDentity. See SSID.
Service Type [166](#), [247](#)
Services [137](#)
SMTP [137](#)
Smurf [148](#), [149](#)
SNMP [137](#), [206](#)
 Manager [207](#)
 MIBs [207](#)
Source Address [158](#)
Splitters [308](#)
SSID [108](#)
 hide [109](#)
Stateful Inspection [35](#), [144](#), [145](#), [150](#)
 Process [151](#)
 ZyXEL device [151](#)
Static Route [182](#)
SUA [135](#)
SUA (Single User Account) [135](#)
SUA vs NAT [135](#)
subnet [290](#)

Subnet Mask [96](#), [164](#)
 subnet mask [292](#)
 subnetting [292](#)
 Supporting Disk [32](#)
 Sustain Cell Rate (SCR) [85](#), [90](#)
 Sustained Cell Rate (SCR) [80](#)
 SYN Flood [147](#), [148](#)
 SYN-ACK [148](#)
 Syntax Conventions [32](#)
 Syslog [169](#)
 System Name [227](#)
 System Parameter Table Generator [256](#)
 System Timeout [203](#)

T

TCP Maximum Incomplete [174](#), [175](#)
 TCP Security [152](#)
 TCP/IP [146](#), [147](#)
 Teardrop [147](#)
 Telnet [204](#)
 Temporal Key Integrity Protocol (TKIP) [337](#)
 Text File Format [256](#)
 TFTP Restrictions [202](#)
 Three-Way Handshake [147](#)
 Threshold Values [173](#)
 TMM QoS. See also QoS.
 Traceroute [150](#)
 trademarks [2](#)
 Traffic Redirect [90](#), [91](#)
 Traffic redirect [90](#), [92](#)
 traffic redirect [36](#)
 Traffic shaping [80](#)
 Triangle [350](#)
 Triangle Route Solutions [351](#)

U

UBR (Unspecified Bit Rate) [85](#), [89](#)
 UDP/ICMP Security [152](#)
 Universal Plug and Play [214](#)
 Application [214](#)
 Security issues [215](#)
 Universal Plug and Play (UPnP) [36](#)
 UPnP [214](#)
 Forum [215](#)

Upper Layer Protocols [152](#), [153](#)
 User Authentication [338](#)
 user authentication [110](#)
 local (user) database [110](#)
 RADIUS server [110](#)
 weaknesses [110](#)
 User Name [199](#)

V

VBR (Variable Bit Rate) [85](#), [89](#)
 VC-based Multiplexing [78](#)
 Virtual Channel Identifier (VCI) [78](#)
 virtual circuit (VC) [77](#)
 Virtual Path Identifier (VPI) [78](#)
 VPI & VCI [78](#)

W

WAN (Wide Area Network) [76](#)
 WAN backup [91](#)
 WAN to LAN Rules [159](#)
 warranty
 note [7](#)
 Web [203](#)
 Web Configurator [42](#), [44](#), [45](#), [153](#), [158](#)
 web configurator screen summary [45](#)
 WEP (Wired Equivalent Privacy) [38](#)
 WEP Encryption [116](#)
 WEP encryption [114](#)
 Wi-Fi Multimedia QoS [126](#)
 Wi-Fi Protected Access [337](#)
 Wi-Fi Protected Access (WPA) [38](#)
 wireless client [108](#)
 Wireless Client WPA Supplicants [338](#)
 Wireless LAN MAC Address Filtering [38](#)
 wireless network [108](#)
 basic guidelines [108](#)
 wireless networks
 channel [108](#)
 encryption [110](#)
 MAC address filter [109](#)
 security [109](#)
 SSID [108](#)
 Wireless security [333](#)
 wireless security [109](#)
 WLAN
 Interference [330](#)

- Security parameters [340](#)
- WPA [337](#)
- WPA compatible [111](#)
- WPA2 [337](#)
- WPA2-Pre-Shared Key [337](#)
- WPA2-PSK [337](#)
- WPA-PSK [337](#)
- WWW [131](#)

Z

- Zero Configuration Internet Access [35](#)
- Zero configuration Internet access [81](#)
- ZyXEL_s Firewall
 - Introduction [145](#)