

Prestige 650H-E Series

ADSL Router

Compact Guide

Version 3.40

August 2003

ZyXEL
Unleash Networking Power

Table of Contents

1	Introducing the Prestige	3
2	Hardware	4
	2.1 <i>Rear Panel Connections.....</i>	4
	2.2 <i>The Front Panel LEDs</i>	5
3	Setting Up Your Computer's IP Address.....	6
	3.1 <i>Windows 2000/NT/XP</i>	6
	3.2 <i>Checking/Updating Your Computer's IP Address</i>	7
	3.3 <i>Testing the Connection to the Prestige</i>	7
4	Configuring Your Prestige	8
	4.1 <i>Accessing Your Prestige Via Web Configurator</i>	8
	4.2 <i>Common Screen Command Buttons</i>	10
	4.3 <i>Internet Access Using the Wizard</i>	10
	4.4 <i>Test Your Internet Connection</i>	15
5	Advanced Configuration	15
	5.1 <i>Network Address Translation Overview.....</i>	15
	5.2 <i>Configuring SUA Server</i>	16
	5.3 <i>Configuring Address Mapping.....</i>	18
	5.4 <i>Firewall Overview.....</i>	19
	5.5 <i>Enabling the Firewall</i>	20
	5.6 <i>Procedure for Configuring Firewall Rules</i>	21
	5.7 <i>Configuring Source and Destination Addresses</i>	25
	5.8 <i>UPnP Overview.....</i>	26
	5.9 <i>Configuring UPnP</i>	26
6	Troubleshooting	28

1 Introducing the Prestige

The Prestige 650H-E ADSL router is the ideal all-in-one device for small networks connecting to the Internet via ADSL. Key features of the Prestige include NAT, Firewall and UPnP. See your *User's Guide* for more details on all Prestige features.

You should have an Internet account already set up and have been given most of the following information.

INTERNET ACCOUNT INFORMATION	
Your device's WAN IP Address (if given): _____	
DNS Server IP Address (if given): Primary _____, Secondary _____	
Virtual Path Identifier (VPI): _____	
Virtual Channel Identifier (VCI): _____	
Multiplexing (VC-based or LLC-based): <input type="checkbox"/> VC <input type="checkbox"/> LLC	
Encapsulation:	
<input type="radio"/> RFC 1483	
<input type="radio"/> ENET ENCAP	Ethernet Encapsulation Gateway IP Address: _____
<input type="radio"/> PPPoA	User Name: _____ Password: _____
<input type="radio"/> PPPoE	Service Name: _____ User Name: _____ Password: _____

2 Hardware

2.1 Rear Panel Connections

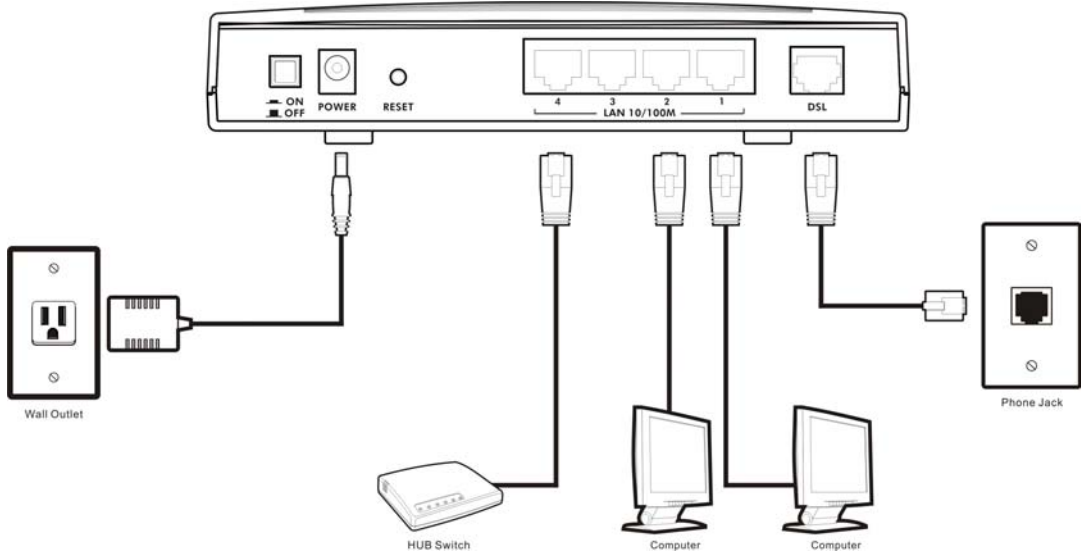

Figure 1 Prestige Hardware Connections

Table 1 Prestige Rear Panel Description

LABEL	DESCRIPTION
1. DSL	Connect to a telephone jack using the included phone wire.
2. LAN 1..4	Connect to a computer/external hub using an Ethernet cable.
3. POWER	Connect to a power source using the power adapter for your region (see your <i>User's Guide</i>).
<p>After you've made the connections, connect the power cable to a power supply and push in the power button to turn on the Prestige.</p>	
<p>The PWR LED turns on. The SYS LED blinks while performing system testing and then turns steady on if the testing is successful. A LAN LED turns on if a LAN port is properly connected.</p>	
RESET	<p>You only need to use this button if you've forgotten the Prestige's password. It returns the Prestige to the factory defaults (password is 1234, LAN IP address 192.168.1.1 etc.; see your <i>User's Guide</i> for details).</p>

2.2 The Front Panel LEDs



Figure 2 Prestige Front Panel

Refer to the following table for more detailed LED descriptions.

Table 2 Front Panel LED Description

LED	COLOR	STATUS	DESCRIPTION
PWR/SYS	Green	On	The Prestige is receiving power and functioning properly.
		Blinking	The Prestige is rebooting.
		Off	The system is not ready or has malfunctioned.
	Red	On	Power to the Prestige is too low.
DSL	Green	On	The Prestige is linked successfully to a DSLAM.
		Blinking	The Prestige is initializing the DSL line.
		Off	The DSL link is down.
PPP/ACT	Green	Blinking	The Prestige is sending/receiving data.
		Off	The system is ready, but is not sending/receiving data.
	Amber	On	The connection to the PPPoE server is up.
LAN 1-4	Green	On	The Prestige has a successful 10Mb Ethernet connection.
		Blinking	The Prestige is sending/receiving data.
		Off	The Prestige does not have 10Mb Ethernet connection.
	Amber	On	The Prestige has a successful 100Mb Ethernet connection.
		Blinking	The Prestige is sending/receiving data.
		Off	The Prestige does not have 100Mb Ethernet connection.

3 Setting Up Your Computer's IP Address

Skip this section if your computer is already set up to accept a dynamic IP address. This is the default for most new computers.

The Prestige is already set up to assign your computer an IP address. Use this section to set up your computer to receive an IP address or assign it a static IP address in the 192.168.1.2 to 192.168.1.254 range with a subnet mask of 255.255.255.0. This is necessary to ensure that your computer can communicate with your Prestige.

Your computer must have an Ethernet card and TCP/IP installed. TCP/IP should already be installed on computers using Windows NT/2000/XP, Macintosh OS 7 and later operating systems.

3.1 Windows 2000/NT/XP

1. In Windows XP, click **start, Control Panel**. In Windows 2000/NT, click **Start, Settings, Control Panel**.
2. In Windows XP, click **Network Connections**.
In Windows 2000/NT, click **Network and Dial-up Connections**.
3. Right-click **Local Area Connection** and then click **Properties**.
4. Select **Internet Protocol (TCP/IP)** (under the **General** tab in Win XP) and click **Properties**.
5. The **Internet Protocol TCP/IP Properties** screen opens (the **General** tab in Windows XP).

- To have your computer assigned a dynamic IP address, click **Obtain an IP address automatically**.

If you know your DNS sever IP address(es), type them in the **Preferred DNS server** and/or **Alternate DNS server** fields.

-To configure a static IP address, click **Use the following IP Address** and fill in the **IP address** (choose one from 192.168.1.2 to 192.168.1.254), **Subnet mask** (255.255.255.0), and **Default gateway** (192.168.1.1) fields.

Then enter your DNS server IP address(es) in the **Preferred DNS server** and/or **Alternate DNS server** fields.

If you have more than two DNS servers, click **Advanced**, the **DNS** tab and then configure them using **Add**.

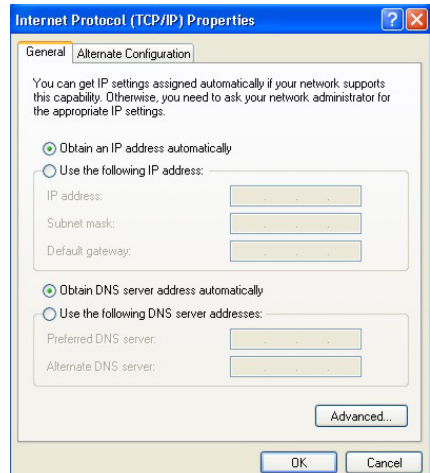

6. Click **Advanced**. Remove any previously installed gateways in the **IP Settings** tab and click **OK** to go back to the **Internet Protocol TCP/IP Properties** screen.

7. Click **OK** to close the **Internet Protocol (TCP/IP) Properties** window.
8. Click **OK** to close the **Local Area Connection Properties** window.

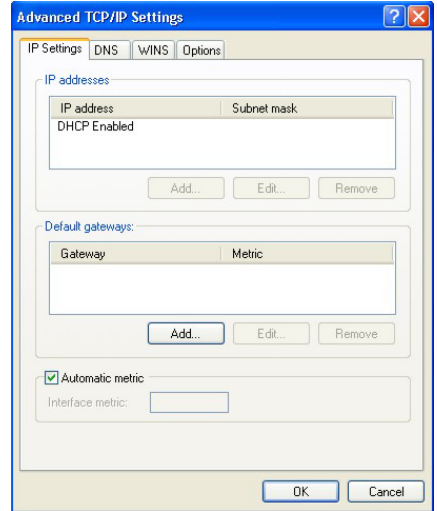

3.2 Checking/Updating Your Computer's IP Address

1. In the computer, click **Start, (All) Programs, Accessories** and then **Command Prompt**.
2. In the **Command Prompt** window, type "ipconfig" and then press **ENTER** to verify that your computer's IP address is in the correct range (192.168.1.2 to 192.168.1.254) with subnet mask 255.255.255.0. This is necessary in order to communicate with the Prestige.

Refer to your *User's Guide* for detailed IP address configuration for other Windows and Macintosh computer operating systems.

3.3 Testing the Connection to the Prestige

1. Click **Start, (All) Programs, Accessories** and then **Command Prompt**.
2. In the **Command Prompt** window, type "ping" followed by a space and the IP address of the Prestige (192.168.1.1 is the default).

3. Press **ENTER** and the following screen displays.

```
C:\>ping 192.168.1.1

Pinging 192.168.1.1 with 32 bytes of data:

Reply from 192.168.1.1: bytes=32 time=10ms TTL=254
Reply from 192.168.1.1: bytes=32 time<10ms TTL=254
Reply from 192.168.1.1: bytes=32 time<10ms TTL=254
Reply from 192.168.1.1: bytes=32 time<10ms TTL=254

Ping statistics for 192.168.1.1:
    Packets: Sent = 4, Received = 4, Lost = 0 (0% loss),
    Approximate round trip times in milli-seconds:
        Minimum = 0ms, Maximum = 10ms, Average = 2ms
```

Your computer can now communicate with the Prestige using the LAN port.

4 Configuring Your Prestige

This *Compact Guide* shows you how to use the web configurator only. See your *User's Guide* for background information on all Prestige features and SMT (System Management Terminal) configuration.

4.1 Accessing Your Prestige Via Web Configurator

- Step 1.** Launch your web browser. Enter “192.168.1.1” as the web site address.

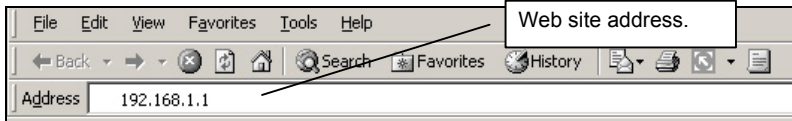

Figure 3 Entering Prestige LAN IP Address in Internet Explorer

- Step 2.** An **Enter Network Password** window displays. Enter the user name (“admin” is the default), password (“1234” is the default) and click **OK**.

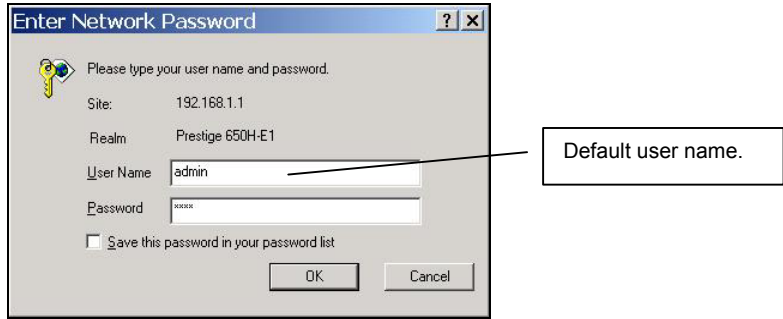

Figure 4 Web Configurator: Password Screen

Step 3. You should now see the web configurator **Site Map** screen.

- Click **Wizard Setup** to begin a series of screens to configure your Prestige for the first time.
- Click a link under **Advanced Setup** to configure advanced Prestige features.
- Click a link under **Maintenance** to see Prestige performance statistics, upload firmware and back up, restore or upload a configuration file.
- Click **Logout** in the navigation panel when you have finished a Prestige management session.



Figure 5 Web Configurator: Site Map Screen

**The Prestige automatically logs you out if it is left idle for five minutes;
press ENTER to log back in again.**

4.2 Common Screen Command Buttons

The following table shows common command buttons found on many web configurator screens.

Back	Click Back to return to the previous screen.
Apply	Click Apply to save your changes back to the Prestige.
Reset/Cancel	Click Reset or Cancel to begin configuring this screen afresh.

4.3 Internet Access Using the Wizard

Use the Wizard Setup screens to configure your system for Internet access settings and fill in the fields with the information in the *Internet Account Information* table. Your ISP may have already configured some of the fields in the wizard screens for you.

Step 1. In the **Site Map** screen click **Wizard Setup** to display the first wizard screen.

The screenshot shows a web-based configuration screen titled "Wizard Setup - ISP Parameters for Internet Access". It contains the following fields and controls:

- Mode:** A drop-down menu with "Routing" selected.
- Encapsulation:** A drop-down menu with "PPPoA" selected.
- Multiplex:** A drop-down menu with "LLC" selected.
- Virtual Circuit ID:** Two text input fields. The "VPI" field contains the number "8" and the "VCI" field contains the number "35".
- Next:** A button located at the bottom right of the form.

Figure 6 Wizard Screen 1

From the **Mode** drop-down list box, select **Routing** (default) if your ISP allows multiple computers to share an Internet account. Otherwise select **Bridge**.

Select the encapsulation type your ISP uses from the **Encapsulation** drop-down list box. Choices vary depending on what you select in the **Mode** field.

Select the multiplexing method used by your ISP from the **Multiplex** drop-down list box.

Enter the correct Virtual Path Identifier (VPI) and Virtual Channel Identifier (VCI) numbers supplied by your ISP in the **VPI** and **VCI** fields. These fields may already be configured.

Click **Next**.

Step 2. The second wizard screen varies depending on what mode and encapsulation type you use. All screens shown are with routing mode. Configure the fields and click **Next** to continue.

Figure 7 Internet Connection with PPPoE

From the **Network Address Translation** drop-down list box, select **SUA Only**, **Full Feature** or **None**. Refer to the *Network Address Translation* section for more information.

Figure 8 Internet Connection with RFC 1483

If your ISP provides the name of your PPPoE service provider, enter it in the **Service Name** field.

Enter the user name and password *exactly* as your ISP assigned them.

Select **Obtain an IP Address Automatically** if you have a dynamic IP address; otherwise select **Static IP Address** and type your ISP assigned IP address in the text box below.

Select **Connect on Demand** when you don't want the connection up all the time and specify an idle time-out period (in seconds) in the **Max. Idle Timeout** field.

Select **Nailed-Up Connection** when you want your connection up all the time. The Prestige will try to bring up the connection automatically if it is disconnected.

Enter the IP address given by your ISP in the **IP Address** field.

The IP Address field is not available for bridge mode.

Refer to *Figure 7* for description of the **Network Address Translation** field.

The screenshot shows the 'Wizard Setup - ISP Parameters for Internet Access' window. Under the 'IP Address' section, the 'Obtain an IP Address Automatically' radio button is selected. Below this, there are three input fields: 'IP Address' with '0.0.0.0', 'Subnet Mask' with '0.0.0.0', and 'ENET ENCAP Gateway' with '0.0.0.0'. The 'Network Address Translation' section has a dropdown menu set to 'SUA Only'. At the bottom, there are 'Back' and 'Next' buttons.

In the **ENET ENCAP Gateway** field, enter the gateway IP address given by your ISP.

Refer to *Figure 7* for other field descriptions.

Figure 9 Internet Connection with ENET ENCAP

The screenshot shows the 'Wizard Setup - ISP Parameters for Internet Access' window. It includes fields for 'User Name' and 'Password'. Under the 'IP Address' section, the 'Obtain an IP Address Automatically' radio button is selected, with a single input field containing '0.0.0.0'. The 'Connection' section has the 'Connect on Demand: Max Idle Timeout' radio button selected, with a value of '0' in the adjacent field. The 'Network Address Translation' section has a dropdown menu set to 'SUA Only'. At the bottom, there are 'Back' and 'Next' buttons.

Refer to *Figure 7* for field descriptions.

The IP Address and Network Address Translation fields are *not* available for bridge mode.

Figure 10 Internet Connection with PPPoA

Step 3. Verify the settings in the screen shown next. To change the LAN information on the Prestige, click **Change LAN Configurations**. Otherwise click **Save Settings** to save the configuration and skip to step 5.

Wizard Setup - ISP Parameters for Internet Access

WAN Information:
Mode: **Routing**
Encapsulation: **PPPoE**
Multiplexing: **LLC**
VPI/VCI: **8/35**
Service Name:
User Name: **user@isp.ch**
Password: *********
IP Address: **Obtain an IP Address Automatically**
NAT: **SUA Only**
Connect on Demand: **Max Idle Timeout 1500 Secs.**

LAN Information:
IP Address: **192.168.1.1**
IP Mask: **255.255.255.0**
DHCP: **ON**
Client IP Pool Starting Address: **192.168.1.33**
Size of Client IP Pool: **32**

Change LAN Configuration

Save Settings

Figure 11 Wizard Screen 3

Step 1. If you want to change your Prestige LAN settings, click **Change LAN Configuration** to display the screen as shown next.

Wizard Setup - ISP Parameters for Internet Access

LAN IP Address

LAN Subnet Mask

DHCP

DHCP Server

Client IP Pool Starting Address

Size of Client IP Pool

Primary DNS Server

Secondary DNS Server

Figure 12 Wizard: LAN Configuration

Specify the first of the contiguous addresses in the IP address pool in the **Client IP Pool Starting Address** field.

Specify the size or count of the IP address pool in the **Size of Client IP Pool** field.

Enter the IP address(es) of the DNS server(s) in the **Primary DNS Server** and/or **Secondary DNS Server** fields.

Step 2. The Prestige automatically tests the connection to the computer(s) connected to the LAN ports. To test the connection from the Prestige to the ISP, click **Start Diagnose**. Otherwise click **Return to Main Menu** to go back to the **Site Map** screen.

Enter the IP address of your Prestige in dotted decimal notation in the **LAN IP Address** field. For example, 192.168.1.1 (factory default).

If you change the Prestige's LAN IP address, you must use the new IP address if you want to access the web configurator again.

Enter a subnet mask in dotted decimal notation in the **LAN Subnet Mask** field.

From the **DHCP Server** drop-down list box, select **On** to allow your Prestige to assign IP addresses, an IP default gateway and DNS servers to computer systems that support the DHCP client. Select **Off** to disable DHCP server.

When DHCP server is used, set the following items:

Wizard Setup - ISP Parameters for Internet Access

LAN connections

Test your Ethernet Connection PASS

WAN connections

Test ADSL synchronization PASS

Test ADSL(ATM OAM) loopback test PASS

Test PPP/PPPoE server connection PASS

Ping default gateway PASS

Figure 13 Wizard Screen 4

4.4 Test Your Internet Connection

Launch your web browser and navigate to www.zyxel.com. Internet access is just the beginning. Refer to the *User's Guide* for more detailed information on the complete range of Prestige features. If you cannot access the Internet, open the web configurator again to confirm that the Internet settings you configured in the Wizard Setup are correct.

5 Advanced Configuration

This section shows how to configure some of the advanced features of the Prestige.

5.1 Network Address Translation Overview

NAT (Network Address Translation - NAT, RFC 1631) is the translation of the IP address of a host in a packet. For example, the source address of an outgoing packet, used within one network is changed to a different IP address known within another network.

In the simplest form, NAT changes the source IP address in a packet received from a subscriber (the inside local address) to another (the inside global address) before forwarding the packet to the WAN side. When the response comes back, NAT translates the destination address (the inside global address) back to the inside local address before forwarding it to the original inside host. Note that the IP address (either local or global) of an outside host is never changed.

NAT supports five types of IP/port mapping. They are:

1. **One-to-One:** One-to-one mode maps one local IP address to one global IP address. Note that port numbers do not change for One-to-one NAT mapping type.
2. **Many-to-One:** Many-to-One mode maps multiple local IP addresses to one global IP address.
3. **Many-to-Many Overload:** Many-to-Many Overload mode maps multiple local IP addresses to shared global IP addresses.
4. **Many-to-Many No Overload:** Many-to-Many No Overload mode maps each local IP address to unique global IP addresses.
5. **Server:** This type allows you to specify inside servers of different services behind the NAT to be accessible to the outside world.

SUA (Single User Account) is a Zynos implementation of a subset of NAT that supports two types of mapping, **Many-to-One** and **Server**. The Prestige also supports **Full Feature** NAT to map multiple global IP addresses to multiple private LAN IP addresses of clients or servers using mapping types.

5.2 Configuring SUA Server

An SUA server set is a list of inside (behind NAT on the LAN) servers, for example, web or FTP, that you can make visible to the outside world even though SUA makes your whole inside network appear as a single computer to the outside world.

Table 3 Common Services and Port Numbers

SERVICES	PORT NUMBER	SERVICES	PORT NUMBER
ECHO	7	HTTP (Hyper Text Transfer protocol or WWW, Web)	80
FTP (File Transfer Protocol)	21	POP3 (Post Office Protocol)	110
SMTP (Simple Mail Transfer Protocol)	25	NNTP (Network News Transport Protocol)	119
DNS (Domain Name System)	53	SNMP (Simple Network Management Protocol)	161
Finger	79	SNMP trap	162
		PPTP (Point-to-Point Tunneling Protocol)	1723

Let's say you want to assign ports 22-25 to one server, port 80 to another and assign a default server IP address of 192.168.1.35 as shown in the next figure.

The NAT network appears as a single host on the Internet

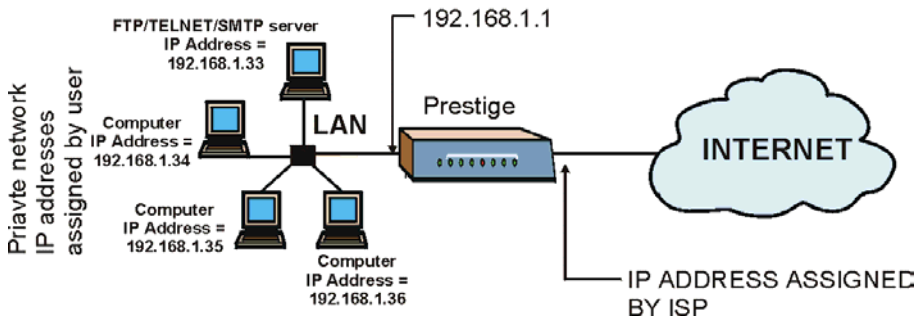

Figure 14 Multiple Servers Behind NAT Example

If you do not assign an IP Address, then all packets received for ports not specified in this screen will be discarded.

From the main screen click **Advanced Setup** and then **NAT** to open the main **NAT** screen. Select **SUA Only** and click **Edit Details**.

NAT - Edit SUA/NAT Server Set

	Start Port No.	End Port No.	IP Address
1	All ports	All ports	0.0.0.0
2	0	0	0.0.0.0
3	0	0	0.0.0.0
4	0	0	0.0.0.0
5	0	0	0.0.0.0
6	0	0	0.0.0.0
7	0	0	0.0.0.0
8	0	0	0.0.0.0
9	0	0	0.0.0.0
10	0	0	0.0.0.0
11	0	0	0.0.0.0
12	0	0	0.0.0.0

Save Reset

Figure 15 SUA/NAT Server

The following table describes the labels in this screen.

Table 4 SUA/NAT Server

LABEL	DESCRIPTION
Start Port No.	Type a port number in this field. To forward only one port, type the port number again in the End Port field. To forward a series of ports, type the start port number here and the end port number in the End Port field.
End Port No.	Type a port number in this field. To forward only one port, type the port number in the Start Port field above and then type it again in this field. To forward a series of ports, type the last port number in a series that begins with the port number in the Start Port field above.
IP Address	Enter the inside IP address of the server here.

5.3 Configuring Address Mapping

Some applications do not support NAT mapping using TCP or UDP port address translation. In this case it is better to use **Many-To-Many No Overload** mapping as port numbers do *not* change for **Many-To-Many No Overload** (and **One-to-One**) NAT mapping types. The following figure illustrates this.

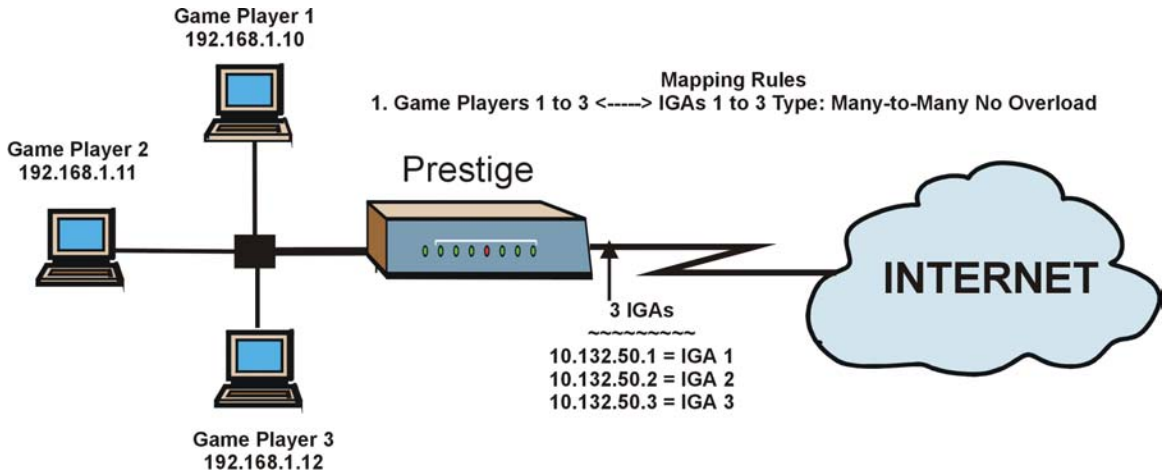

Figure 16 NAT Example

Applications such as some gaming programs are NAT unfriendly because they embed addressing information in the data stream. These applications won't work through NAT even when using One-to-One and Many-To-Many No Overload mapping types.

Ordering your rules is important because the Prestige applies the rules in the order that you specify.

To change your Prestige's address mapping settings, click **Advanced Setup** and **NAT**. Select **Full Feature** and click **Edit Details**. Click on a rule to display the configuration screen as shown.

NAT - Edit Address Mapping Rule 1

Type: One-to-One

Local Start IP: 0.0.0.0

Local End IP: N/A

Global Start IP: 0.0.0.0

Global End IP: N/A

Server Mapping Set: N/A [Edit Details](#)

Apply Reset Delete

Figure 17 NAT: Address Mapping

The following table describes the labels in this screen.

Table 5 NAT: Address Mapping

LABEL	DESCRIPTION
Type	Choose the port mapping type from the drop-down list box. Refer to the mapping types as discussed previously.
Local Start IP	This refers to the Inside Local Address (ILA), that is the starting local IP address. Local IP addresses are N/A for Server port mapping.
Local End IP	This is the end local IP address. If the rule is for all local IP addresses, then this field displays 0.0.0.0 and 255.255.255.255 as the Local End IP address. This field is N/A for One-to-One and Server mapping types.
Global Start IP	This refers to the global IP address. 0.0.0.0 is for a dynamic IP address from your ISP with Many-to-One and Server mapping types.
Global End IP	This is the ending Inside Global Address (IGA), that is the starting global IP address. This field is N/A for One-to-One , Many-to-One and Server mapping types.
Server Mapping Set	Click this link to go to the NAT - Edit SUA/NAT Server Set screen to edit a server set that you have selected in the Server Mapping Set field. Refer to the SUA/NAT Server section.

5.4 Firewall Overview

The Prestige firewall is a stateful inspection firewall and is designed to protect against Denial of Service attacks when activated. The Prestige’s purpose is to allow a private Local Area Network (LAN) to be securely connected to the Internet. The Prestige can be used to prevent theft, destruction and modification of data, as well as log events, which may be important to the security of your network. The Prestige also has packet-filtering capabilities.

When activated, the firewall allows all traffic to the Internet that originates from the LAN, and blocks all traffic to the LAN that originates from the Internet. In other words the Prestige will:

- Allow all sessions originating from the LAN to the WAN**
- Deny all sessions originating from the WAN to the LAN**

LAN-to-WAN rules are local network to Internet firewall rules. The default is to forward all traffic from your local network to the Internet.

The following figure illustrates a Prestige firewall application.

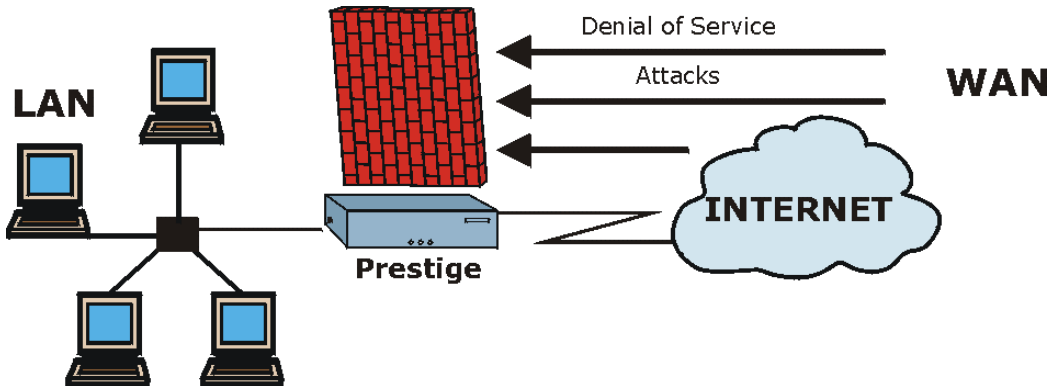

Figure 18 Prestige Firewall Application

5.5 Enabling the Firewall

From the main screen, click **Advanced Setup, Firewall** and then **Config** to open the **Configuration** screen. Enable (or activate) the firewall by selecting the **Enable Firewall** check box as seen in the following screen.

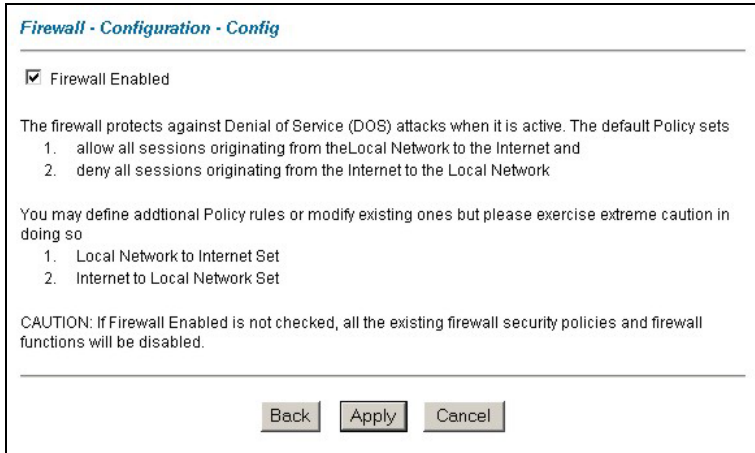

Figure 19 Enabling the Firewall

5.6 Procedure for Configuring Firewall Rules

From the main screen, click **Advanced Setup**, **Firewall** and then **Rule Summary** (for either local network to Internet rules or Internet to local network rules) to open the **Summary** screen. The following table describes the fields in this screen.

Prestige 650H-E

Firewall - LAN to WAN - Rule Summary

The default action for packets not matching following rules: Forward

Default Permit Log

No.	Source IP	Destination IP	Service	Action	Log
1	▼	▼	▼		
2	▼	▼	▼		
3	▼	▼	▼		
4	▼	▼	▼		
5	▼	▼	▼		
6	▼	▼	▼		
7	▼	▼	▼		
8	▼	▼	▼		
9	▼	▼	▼		
10	▼	▼	▼		

Rules Reorder: Move rule number 1 to rule number 1 Move

Back
Apply
Cancel

Figure 20 Rule Summary

The following table describes the labels in this screen.

Table 6 Rule Summary

LABEL	DESCRIPTION
The default action for packets not matching following rules	Should packets that do not match the following rules be blocked or forwarded? Make your choice from the drop down list box. Note that "block" means the firewall silently discards the packet.
Default Permit Log	Click this check box to log all matched rules in the ACL default set.
The following read-only fields summarize the rules you have created that apply to traffic traveling in the selected packet direction. The firewall rules that you configure (summarized below) take priority over the general firewall action settings above.	
No.	This is your firewall rule number. The ordering of your rules is important as rules are applied in turn. The Move field below allows you to reorder your rules.
Source IP	This drop-down list box displays the source addresses or ranges of addresses to which this firewall rule applies. Please note that a blank source or destination address is equivalent to Any .

Table 6 Rule Summary

LABEL	DESCRIPTION
Destination IP	This drop-down list box displays the destination addresses or ranges of addresses to which this firewall rule applies. Please note that a blank source or destination address is equivalent to Any .
Service	This drop-down list box displays the services to which this firewall rule applies. Please note that a blank service type is equivalent to Any .
Action	This is the specified action for that rule, either Block or Forward . Note that Block means the firewall silently discards the packet.
Log	This field shows you if a log is created for packets that match the rule (Match), don't match the rule (Not Match), both (Both) or no log is created (None).
Rules Reorder	You may reorder your rules using this function. Select the rule you want to move. The ordering of your rules is important as rules are applied in turn.
To Rule Number	Select the number you want to move the rule to.
Move	Click Move to move the rule.

Follow these directions to create a new rule.

- Step 1.** In the **Summary** screen, click a rule's index number. The **Edit Rule** screen opens.
- Step 2.** In the **Available Services** text box, select the services you want. Configure customized ports for services not predefined by the Prestige by clicking the **Add** or **Edit** buttons under **Custom Port**. For a comprehensive list of port numbers and services, visit the IANA (Internet Assigned Number Authority) web site.
- Step 3.** Configure the **Source Address** and **Destination Address** for the rule.

Firewall - LAN to WAN - Edit Rule 1

Source Address:

Source IP Address #####
Any

SrcAdd SrcEdit SrcDelete

Destination Address:

Destination IP Address ###
Any

DestAdd DestEdit DestDelete

Service:

Available Services:

- AIM/NEW-ICQ(TCP:5190)
- AUTH(TCP:113)
- BGP(TCP:179)
- BOOTP_CLIENT(UDP:68)
- BOOTP_SERVER(UDP:67)

[Edit Available Service](#)

<< >>

Selected Services:

- Any(UDP)
- Any(TCP)

Action for Matched Packets: Forward

Log: None

Alert

Apply Cancel Delete

Figure 21 Creating/Editing A Firewall Rule

The following table describes the labels in this screen.

Table 7 Creating/Editing A Firewall Rule

LABEL	DESCRIPTION
Source Address	Click SrcAdd to add a new address, SrcEdit to edit an existing one or SrcDelete to delete one. Please see the next section for more information on adding and editing source addresses.
Destination Address	Click DestAdd to add a new address, DestEdit to edit an existing one or DestDelete to delete one. Please see the following section on adding and editing destination addresses.

Table 7 Creating/Editing A Firewall Rule

LABEL	DESCRIPTION
Services Available/ Selected Services	Highlight a service from the Available Services box on the left, then click >> to add it to the Selected Services box on the right. To remove a service, highlight it in the Selected Services box on the right, then click <<.
Edit Available Service	Click this button to go to the list of available custom services.
Action for Matched Packets	Should packets that match this rule be blocked or forwarded? Make your choice from the drop down list box. Note that Block means the firewall silently discards the packet.
Log	This field determines if a log is created for packets that match the rule, don't match the rule, both or no log is created.
Alert	Check the Alert check box to determine that this rule generates an alert when the rule is matched.
Delete	Click Delete to remove this rule.

5.7 Configuring Source and Destination Addresses

To add a new source or destination address, click **SrcAdd** or **DestAdd** from the previous screen. To edit an existing source or destination address, select it from the box and click **SrcEdit** or **DestEdit** from the previous screen. Either action displays the following screen.

Firewall - LAN to WAN - Rule IP Config

Address Type: Subnet Address

Start IP Address: 0.0.0.0

End IP Address: 0.0.0.0

Subnet Mask: 0.0.0.0

Apply Cancel

Figure 22 Adding/Editing Source and Destination Addresses

The following table describes the labels in this screen.

Table 8 Adding/Editing Source and Destination Addresses

LABEL	DESCRIPTION
Address Type	Do you want your rule to apply to packets with a particular (single) IP address, a range of IP addresses (e.g., 192.168.1.10 to 192.169.1.50), a subnet or any IP address? Select an option from the drop down list box
Start IP Address	Enter the single IP address or the starting IP address in a range here.
End IP Address	Enter the ending IP address in a range here.
Subnet Mask	Enter the subnet mask here, if applicable.

5.8 UPnP Overview

Universal Plug and Play (UPnP) is a distributed, open networking standard that uses TCP/IP for simple peer-to-peer network connectivity between devices. A UPnP device can dynamically join a network, obtain an IP address, convey its capabilities and learn about other devices on the network. In turn, a device can leave a network smoothly and automatically when it is no longer in use.

All UPnP-enabled devices may communicate freely with each other without additional configuration. Disable UPnP if this is not your intention.

Windows ME and Windows XP support UPnP. See the Microsoft website for information about other Microsoft operating systems.

Make sure you apply Microsoft's UPnP security patch before enabling the UPnP feature. Refer to the Microsoft website.

5.9 Configuring UPnP

Click **Advanced Setup** and then **UPnP** to open the **UPnP** screen.

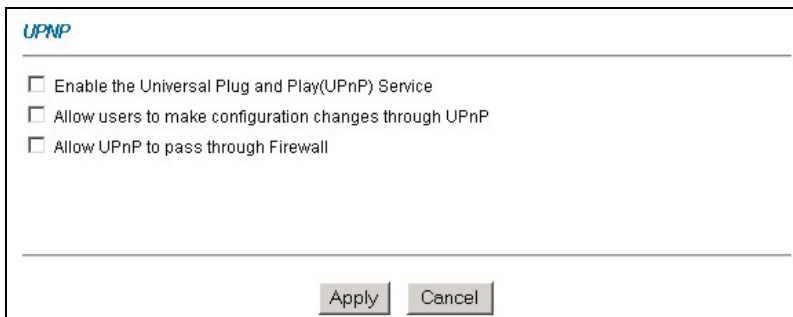
**Figure 23 UPnP**

Prestige 650H-E

The following table describes the labels in this screen.

Table 9 UPnP

FIELD	DESCRIPTION
Enable the Universal Plug and Play (UPnP) Service	Select this checkbox to activate UPnP. Be aware that anyone could use a UPnP application to open the web configurator's login screen without entering the Prestige's IP address (although you must still enter the password to access the web configurator).
Allow users to make configuration changes through UPnP	Select this check box to allow UPnP-enabled applications to automatically configure the Prestige so that they can communicate through the Prestige, for example by using NAT Traversal. UPnP applications automatically reserve a NAT forwarding port in order to communicate with another UPnP enabled device; this eliminates the need to manually configure port forwarding for the UPnP enabled application.
Allow UPnP to pass through Firewall	This field is not available on all models. Select this check box to allow traffic from UPnP-enabled applications to bypass the firewall. Clear this check box to have the firewall block all UPnP application packets (for example, MSN packets).

6 Troubleshooting

Table 10 Troubleshooting

PROBLEM	CORRECTIVE ACTION
None of the LEDs turn on when you turn on the Prestige.	<p>Make sure that you have the correct power adapter connected to the Prestige and plugged in to an appropriate power source. Check all cable connections.</p> <p>If the LEDs still do not turn on, you may have a hardware problem. In this case, you should contact your local vendor.</p>
Cannot access the Prestige from the LAN.	<p>Check the cable connection between the Prestige and your computer or hub. Refer to the <i>Rear Panel Connections</i> section for details.</p> <p>Ping the Prestige from a LAN computer. Make sure your computer Ethernet adapter is installed and functioning properly.</p>
Cannot ping any computer on the LAN.	<p>If the LAN LEDs are all off, check the cable connections between the Prestige and your LAN computers.</p> <p>Verify that the IP address, subnet mask of the Prestige and the LAN computers are in the same IP address range.</p>
Cannot get a WAN IP address from the ISP.	<p>The WAN IP is provided after the ISP verifies the MAC address, host name or user ID. Find out the verification method used by your ISP and configure the corresponding fields.</p> <p>If the ISP checks the user ID, check your service type, user name, and password in the WAN screen.</p>
Cannot access the Internet.	<p>Verify the Internet connection settings in the WAN screen.</p> <p>Make sure you entered the correct user name and password.</p> <p>For wireless clients, check that both the Prestige and wireless client(s) are using the same ESSID, channel and WEP keys (if WEP encryption is activated).</p>