

# *Prestige 623R-T*

*ADSL Dual-link Router*

## *User's Guide*

Version 3.40

November 2003



# Copyright

Copyright © 2003 by ZyXEL Communications Corporation.

The contents of this publication may not be reproduced in any part or as a whole, transcribed, stored in a retrieval system, translated into any language, or transmitted in any form or by any means, electronic, mechanical, magnetic, optical, chemical, photocopying, manual, or otherwise, without the prior written permission of ZyXEL Communications Corporation.

Published by ZyXEL Communications Corporation. All rights reserved.

## **Disclaimer**

ZyXEL does not assume any liability arising out of the application or use of any products, or software described herein. Neither does it convey any license under its patent rights nor the patent rights of others. ZyXEL further reserves the right to make changes in any products described herein without notice. This publication is subject to change without notice.

## **Trademarks**

ZyNOS (ZyXEL Network Operating System) is a registered trademark of ZyXEL Communications, Inc. Other trademarks mentioned in this publication are used for identification purposes only and may be properties of their respective owners.

# Federal Communications Commission (FCC) Interference Statement

This device complies with Part 15 of FCC rules. Operation is subject to the following two conditions:

- This device may not cause harmful interference.
- This device must accept any interference received, including interference that may cause undesired operations.

This equipment has been tested and found to comply with the limits for a Class B digital device pursuant to Part 15 of the FCC Rules. These limits are designed to provide reasonable protection against harmful interference in a commercial environment. This equipment generates, uses, and can radiate radio frequency energy, and if not installed and used in accordance with the instructions, may cause harmful interference to radio communications.

If this equipment does cause harmful interference to radio/television reception, which can be determined by turning the equipment off and on, the user is encouraged to try to correct the interference by one or more of the following measures:

1. Reorient or relocate the receiving antenna.
2. Increase the separation between the equipment and the receiver.
3. Connect the equipment into an outlet on a circuit different from that to which the receiver is connected.
4. Consult the dealer or an experienced radio/TV technician for help.

## Notice 1

Changes or modifications not expressly approved by the party responsible for compliance could void the user's authority to operate the equipment.

## Certifications

Refer to the product page at [www.zyxel.com](http://www.zyxel.com).

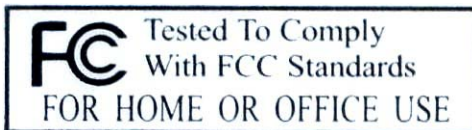

# ZyXEL Limited Warranty

ZyXEL warrants to the original end user (purchaser) that this product is free from any defects in materials or workmanship for a period of up to two years from the date of purchase. During the warranty period, and upon proof of purchase, should the product have indications of failure due to faulty workmanship and/or materials, ZyXEL will, at its discretion, repair or replace the defective products or components without charge for either parts or labor, and to whatever extent it shall deem necessary to restore the product or components to proper operating condition. Any replacement will consist of a new or re-manufactured functionally equivalent product of equal value, and will be solely at the discretion of ZyXEL. This warranty shall not apply if the product is modified, misused, tampered with, damaged by an act of God, or subjected to abnormal working conditions.

## **Note**

Repair or replacement, as provided under this warranty, is the exclusive remedy of the purchaser. This warranty is in lieu of all other warranties, express or implied, including any implied warranty of merchantability or fitness for a particular use or purpose. ZyXEL shall in no event be held liable for indirect or consequential damages of any kind of character to the purchaser.

To obtain the services of this warranty, contact ZyXEL's Service Center for your Return Material Authorization number (RMA). Products must be returned Postage Prepaid. It is recommended that the unit be insured when shipped. Any returned products without proof of purchase or those with an out-dated warranty will be repaired or replaced (at the discretion of ZyXEL) and the customer will be billed for parts and labor. All repaired or replaced products will be shipped by ZyXEL to the corresponding return address, Postage Paid. This warranty gives you specific legal rights, and you may also have other rights that vary from country to country.

## **Safety Warnings**

1. To reduce the risk of fire, use only No. 26 AWG or larger telephone wire.
2. Do not use this product near water, for example, in a wet basement or near a swimming pool.
3. Avoid using this product during an electrical storm. There may be a remote risk of electric shock from lightning.

# Customer Support

Please have the following information ready when you contact customer support.

- Product model and serial number.
- Warranty Information.
- Date that you received your device.
- Brief description of the problem and the steps you took to solve it.

METHOD LOCATION	E-MAIL SUPPORT/SALES	TELEPHONE/FAX	WEB SITE/ FTP SITE	REGULAR MAIL
WORLDWIDE	<a href="mailto:support@zyxel.com.tw">support@zyxel.com.tw</a>  <a href="mailto:sales@zyxel.com.tw">sales@zyxel.com.tw</a>	+886-3-578-3942  +886-3-578-2439	<a href="http://www.zyxel.com">www.zyxel.com</a> <a href="http://www.europe.zyxel.com">www.europe.zyxel.com</a> <a href="ftp://ftp.zyxel.com">ftp.zyxel.com</a> <a href="ftp://ftp.europe.zyxel.com">ftp.europe.zyxel.com</a>	ZyXEL Communications Corp., 6 Innovation Road II, Science- Based Industrial Park, Hsinchu 300, Taiwan.
NORTH AMERICA	<a href="mailto:support@zyxel.com">support@zyxel.com</a> <a href="mailto:sales@zyxel.com">sales@zyxel.com</a>	+1-800-255-4101 +1-714-632-0858	<a href="http://www.us.zyxel.com">www.us.zyxel.com</a> <a href="ftp://ftp.us.zyxel.com">ftp.us.zyxel.com</a>	ZyXEL Communications Inc., 1130 N. Miller St. Anaheim, CA 92806, U.S.A.
SCANDINAVIA	<a href="mailto:support@zyxel.dk">support@zyxel.dk</a> <a href="mailto:sales@zyxel.dk">sales@zyxel.dk</a>	+45-3955-0700 +45-3955-0707	<a href="http://www.zyxel.dk">www.zyxel.dk</a> <a href="ftp://ftp.zyxel.dk">ftp.zyxel.dk</a>	ZyXEL Communications A/S, Columbusvej 5, 2860 Soeborg, Denmark.
GERMANY	<a href="mailto:support@zyxel.de">support@zyxel.de</a> <a href="mailto:sales@zyxel.de">sales@zyxel.de</a>	+49-2405-6909-0 +49-2405-6909-99	<a href="http://www.zyxel.de">www.zyxel.de</a>	ZyXEL Deutschland GmbH. Adenauerstr. 20/A2 D-52146 Wuerselen, Germany

# Table of Contents

<b>ADSL Dual-link Router</b> .....	<b>i</b>
<b>Copyright</b> .....	<b>ii</b>
<b>Federal Communications Commission (FCC) Interference Statement</b> .....	<b>iii</b>
<b>ZyXEL Limited Warranty</b> .....	<b>iv</b>
<b>Customer Support</b> .....	<b>v</b>
<b>Table of Contents</b> .....	<b>vi</b>
<b>List of Figures</b> .....	<b>xiii</b>
<b>List of Tables</b> .....	<b>xvii</b>
<b>List of Charts</b> .....	<b>xix</b>
<b>Preface</b> .....	<b>xx</b>
<b>Introduction to DSL</b> .....	<b>xxii</b>
<b>Getting Started</b> .....	<b>I</b>
<b>Chapter 1 Getting To Know Your Prestige</b> .....	<b>1-1</b>
1.1 Introducing the Prestige 623R-T ADSL Dual-link Router .....	1-1
1.2 Features of the Prestige.....	1-1
1.3 Applications for the Prestige.....	1-3
1.3.1 Internet Access.....	1-3
1.3.2 LAN to LAN Application .....	1-4
<b>Chapter 2 Introducing the Web Configurator</b> .....	<b>2-1</b>
2.1 Web Configurator Overview.....	2-1
2.2 Accessing the Prestige Web Configurator .....	2-1
2.3 Navigating the Prestige Web Configurator .....	2-2
2.4 Configuring Password.....	2-3
2.5 Resetting the Prestige.....	2-4
2.5.1 Using The Reset Button.....	2-4
<b>Chapter 3 Wizard Setup</b> .....	<b>3-1</b>
3.1 Wizard Setup Introduction.....	3-1
3.2 Encapsulation.....	3-1
3.2.1 ENET ENCAP .....	3-1
3.2.2 PPP over Ethernet .....	3-1
3.2.3 PPPoA.....	3-1
3.2.4 RFC 1483.....	3-2
3.3 Multiplexing.....	3-2
3.3.1 VC-based Multiplexing.....	3-2
3.3.2 LLC-based Multiplexing.....	3-2
3.4 VPI and VCI .....	3-2
3.5 Wizard Setup Configuration: First Screen .....	3-2
3.6 IP Address and Subnet Mask .....	3-4
3.7 IP Address Assignment.....	3-4

3.7.1	IP Assignment with PPPoA or PPPoE Encapsulation.....	3-5
3.7.2	IP Assignment with RFC 1483 Encapsulation .....	3-5
3.7.3	IP Assignment with ENET ENCAP Encapsulation .....	3-5
3.7.4	Private IP Addresses.....	3-5
3.8	Nailed-Up Connection (PPP) .....	3-6
3.9	NAT .....	3-6
3.10	Wizard Setup Configuration: Second Screen .....	3-6
3.10.1	PPPoA .....	3-6
3.10.2	RFC 1483 .....	3-8
3.10.3	ENET ENCAP .....	3-9
3.10.4	PPPoE.....	3-11
3.11	DHCP Setup.....	3-12
3.11.1	IP Pool Setup.....	3-13
3.12	Wizard Setup Configuration: Third Screen.....	3-13
3.13	Wizard Setup Configuration: Connection Tests.....	3-15
3.14	Test Your Internet Connection.....	3-16
<b>LAN and WAN .....</b>		<b>II</b>
<b>Chapter 4 LAN Setup .....</b>		<b>4-1</b>
4.1	LAN Overview.....	4-1
4.1.1	LANs, WANs and the Prestige.....	4-1
4.2	DNS Server Address .....	4-1
4.3	DNS Server Address Assignment .....	4-2
4.4	LAN TCP/IP .....	4-2
4.4.1	Factory LAN Defaults.....	4-2
4.4.2	IP Address and Subnet Mask.....	4-3
4.4.3	RIP Setup .....	4-3
4.4.4	Multicast.....	4-3
4.5	Configuring LAN.....	4-4
<b>Chapter 5 WAN Setup .....</b>		<b>5-1</b>
5.1	WAN Overview .....	5-1
5.2	PPPoE Encapsulation .....	5-1
5.3	PPTP Encapsulation .....	5-1
5.4	Traffic Shaping.....	5-2
5.5	WAN Setup.....	5-3
<b>NAT, Dynamic DNS and Time and Date.....</b>		<b>III</b>
<b>Chapter 6 Network Address Translation (NAT).....</b>		<b>6-1</b>
6.1	NAT Overview.....	6-1
6.1.1	NAT Definitions.....	6-1
6.1.2	What NAT Does.....	6-1
6.1.3	How NAT Works.....	6-2
6.1.4	NAT Application.....	6-2

6.1.5	NAT Mapping Types .....	6-3
6.2	SUA (Single User Account) Versus NAT .....	6-4
6.3	SUA Server .....	6-5
6.3.1	Port Forwarding: Services and Port Numbers.....	6-5
6.3.2	Configuring Servers Behind SUA (Example).....	6-6
6.4	Selecting the NAT Mode .....	6-7
6.5	Configuring SUA Server.....	6-8
6.6	Configuring Address Mapping.....	6-10
6.7	Editing an Address Mapping Rule .....	6-12
<b>Chapter 7</b>	<b>Dynamic DNS Setup .....</b>	<b>7-1</b>
7.1	Dynamic DNS .....	7-1
7.1.1	DYNDNS Wildcard .....	7-1
7.2	Configuring Dynamic DNS .....	7-1
<b>Chapter 8</b>	<b>Time and Date Setup .....</b>	<b>8-1</b>
8.1	Configuring Time and Date .....	8-1
	<b>Remote Management and UPnP.....</b>	<b>IV</b>
<b>Chapter 9</b>	<b>Remote Management Configuration.....</b>	<b>9-1</b>
9.1	Remote Management Overview.....	9-1
9.1.1	Remote Management Limitations .....	9-1
9.1.2	Remote Management and NAT .....	9-2
9.1.3	System Timeout .....	9-2
9.2	Telnet .....	9-2
9.3	FTP .....	9-2
9.4	Web.....	9-3
9.5	Configuring Remote Management.....	9-3
<b>Chapter 10</b>	<b>Universal Plug-and-Play (UPnP).....</b>	<b>10-1</b>
10.1	Universal Plug and Play Overview .....	10-1
10.1.1	How do I know if I'm using UPnP? .....	10-1
10.1.2	NAT Traversal .....	10-1
10.1.3	Cautions with UPnP.....	10-1
10.2	UPnP and ZyXEL .....	10-2
10.2.1	Configuring UPnP.....	10-2
10.3	Installing UPnP in Windows Example.....	10-3
10.3.1	Installing UPnP in Windows Me .....	10-3
10.3.2	Installing UPnP in Windows XP.....	10-4
10.4	Using UPnP in Windows XP Example .....	10-5
10.4.1	Auto-discover Your UPnP-enabled Network Device .....	10-5
10.4.2	Web Configurator Easy Access .....	10-7
	<b>Maintenance.....</b>	<b>V</b>
<b>Chapter 11</b>	<b>Maintenance .....</b>	<b>11-1</b>
11.1	Maintenance Overview .....	11-1



11.2	System Status Screen .....	11-1
11.2.1	System Statistics.....	11-4
11.3	DHCP Table Screen.....	11-6
11.4	Diagnostic Screens.....	11-7
11.4.1	Diagnostic General Screen.....	11-7
11.4.2	Diagnostic DSL Line Screen.....	11-9
11.5	Firmware Screen.....	11-10
<b>SMT General Configuration .....</b>		<b>VI</b>
<b>Chapter 12 Introducing the SMT .....</b>		<b>12-1</b>
12.1	SMT Introduction.....	12-1
12.1.1	Procedure for SMT Configuration via Telnet.....	12-1
12.1.2	Prestige SMT Menu Overview.....	12-1
12.2	Navigating the SMT Interface.....	12-3
12.2.1	System Management Terminal Interface Summary.....	12-4
12.3	Changing the System Password.....	12-5
<b>Chapter 13 General Setup.....</b>		<b>13-1</b>
13.1	General Setup.....	13-1
13.2	Configuring Menu 1.....	13-1
13.2.1	Configuring Dynamic DNS.....	13-3
<b>Chapter 14 LAN Setup .....</b>		<b>14-1</b>
14.1	LAN Setup.....	14-1
14.1.1	LAN Port Filter Setup.....	14-1
14.2	Protocol Dependent Ethernet Setup.....	14-2
14.3	TCP/IP Ethernet Setup and DHCP.....	14-2
<b>Chapter 15 Internet Access .....</b>		<b>15-1</b>
15.1	Internet Access Overview.....	15-1
15.2	IP Policies.....	15-1
15.3	IP Alias.....	15-1
15.4	IP Alias Setup.....	15-2
15.5	Route IP Setup.....	15-4
15.6	Internet Access Configuration.....	15-5
<b>Chapter 16 Remote Node Configuration.....</b>		<b>16-1</b>
16.1	Remote Node Setup Overview.....	16-1
16.2	Remote Node Setup.....	16-1
16.2.1	Remote Node Profile.....	16-1
16.2.2	Encapsulation and Multiplexing Scenarios.....	16-2
16.2.3	Outgoing Authentication Protocol.....	16-5
16.3	Metric.....	16-5
16.4	Remote Node Network Layer Options.....	16-6
16.4.1	My WAN Addr Sample IP Addresses.....	16-9
16.5	Remote Node Filter.....	16-9

16.5.1	Web Configurator Internet Security Filter Rules .....	16-10
16.5.2	Web Configurator Filter Sets .....	16-11
16.6	Editing ATM Layer Options .....	16-13
16.6.1	VC-based Multiplexing (non-PPP Encapsulation).....	16-13
16.6.2	LLC-based Multiplexing or PPP Encapsulation .....	16-13
<b>Chapter 17</b>	<b>Static Route Setup.....</b>	<b>17-1</b>
17.1	IP Static Route Overview.....	17-1
17.2	Configuring an IP static route .....	17-2
<b>Chapter 18</b>	<b>Bridging Setup .....</b>	<b>18-1</b>
18.1	Bridging Overview.....	18-1
18.2	Bridge Ethernet Setup.....	18-1
18.2.1	Remote Node Bridging Setup .....	18-1
18.2.2	Bridge Static Route Setup.....	18-3
<b>Chapter 19</b>	<b>Network Address Translation (NAT).....</b>	<b>19-1</b>
19.1	NAT Overview .....	19-1
19.1.1	SUA (Single User Account) Versus NAT .....	19-1
19.2	Applying NAT.....	19-1
19.3	NAT Setup.....	19-3
19.3.1	Address Mapping Sets .....	19-4
19.4	Configuring a Server behind NAT.....	19-9
19.5	General NAT Examples.....	19-11
19.5.1	Example 1: Internet Access Only.....	19-11
19.5.2	Example 2: Internet Access with an Inside Server.....	19-13
19.5.3	Example 3: Multiple Public IP Addresses With Inside Servers.....	19-14
19.5.4	Example 4: NAT Unfriendly Application Programs.....	19-17
<b>SMT Advanced Management.....</b>		<b>VII</b>
<b>Chapter 20</b>	<b>Filter Configuration.....</b>	<b>20-1</b>
20.1	About Filtering.....	20-1
20.2	Configuring a Filter Set .....	20-4
20.2.1	Filter Rules Summary Menu .....	20-6
20.3	Configuring a Filter Rule .....	20-7
20.3.1	TCP/IP Filter Rule .....	20-8
20.3.2	Generic Filter Rule.....	20-12
20.4	Filter Types and NAT .....	20-14
20.5	Example Filter.....	20-14
20.6	Applying Filters and Factory Defaults.....	20-17
20.6.1	Ethernet Traffic.....	20-18
20.6.2	Remote Node Filters .....	20-18
<b>Chapter 21</b>	<b>SNMP Configuration .....</b>	<b>21-1</b>
21.1	SNMP Overview.....	21-1
21.2	Supported MIBs.....	21-2

21.3	SNMP Configuration .....	21-2
21.4	SNMP Traps.....	21-4
<b>Chapter 22</b>	<b>System Information and Diagnosis.....</b>	<b>22-1</b>
22.1	System Maintenance Overview.....	22-1
22.2	System Status .....	22-1
22.3	System Information .....	22-3
22.3.1	System Information .....	22-3
22.3.2	Console Port Speed .....	22-5
22.4	Log and Trace .....	22-5
22.4.1	Viewing Error Log.....	22-5
22.4.2	Syslog and Accounting.....	22-6
22.5	Diagnostic .....	22-8
<b>Chapter 23</b>	<b>Firmware and Configuration File Maintenance.....</b>	<b>23-1</b>
23.1	Filename Conventions.....	23-1
23.2	Backup Configuration .....	23-2
23.2.1	Backup Configuration .....	23-3
23.2.2	Using the FTP Command from the Command Line.....	23-3
23.2.3	Example of FTP Commands from the Command Line.....	23-3
23.2.4	GUI-based FTP Clients .....	23-4
23.2.5	TFTP and FTP over WAN Will Not Work When.....	23-4
23.2.6	Backup Configuration Using TFTP .....	23-5
23.2.7	TFTP Command Example.....	23-5
23.2.8	GUI-based TFTP Clients.....	23-5
23.3	Restore Configuration .....	23-6
23.3.1	Restore Using FTP .....	23-6
23.3.2	Restore Using FTP Session Example.....	23-8
23.4	Uploading Firmware and Configuration Files.....	23-8
23.4.1	Firmware File Upload .....	23-8
23.4.2	Configuration File Upload .....	23-9
23.4.3	FTP File Upload Command from the DOS Prompt Example .....	23-9
23.4.4	FTP Session Example of Firmware File Upload .....	23-10
23.4.5	TFTP File Upload .....	23-10
23.4.6	TFTP Upload Command Example.....	23-11
<b>Chapter 24</b>	<b>System Maintenance .....</b>	<b>24-1</b>
24.1	Command Interpreter Mode Overview .....	24-1
24.2	Call Control Support .....	24-2
24.2.1	Budget Management .....	24-2
24.3	Time and Date Setting.....	24-3
24.3.1	Resetting the Time .....	24-5
<b>Chapter 25</b>	<b>Remote Management.....</b>	<b>25-1</b>
25.1	Remote Management Overview.....	25-1

25.2	Configuring Remote Management .....	25-1
25.2.1	Remote Management Setup .....	25-1
25.2.2	Remote Management Limitations .....	25-2
25.3	Remote Management and NAT .....	25-3
25.4	System Timeout .....	25-3
<b>Chapter 26</b>	<b>IP Policy Routing .....</b>	<b>26-1</b>
26.1	IP Policy Routing Overview .....	26-1
26.2	Benefits of IP Policy Routing .....	26-1
26.3	Routing Policy .....	26-1
26.4	IP Routing Policy Setup .....	26-2
26.5	Applying an IP Policy .....	26-5
26.5.1	Ethernet IP Policies .....	26-5
26.6	IP Policy Routing Example .....	26-7
<b>Chapter 27</b>	<b>Call Scheduling .....</b>	<b>27-1</b>
27.1	Call Scheduling Overview .....	27-1
<b>Appendices and Index .....</b>	<b>VIII</b>	
<b>Appendix A</b>	<b>Troubleshooting.....</b>	<b>A-1</b>
A.1	Using LEDs to Diagnose Problems .....	A-1
A.1.1	Power LED .....	A-1
A.1.2	LAN LED .....	A-1
A.1.3	DSL LED .....	A-2
A.2	Telnet .....	A-2
A.3	Web Configurator .....	A-3
A.4	Login Username and Password .....	A-3
A.5	LAN Interface .....	A-4
A.6	WAN Interface .....	A-4
A.7	Internet Access .....	A-5
A.8	Remote Node Connection .....	A-6
<b>Appendix B</b>	<b>IP Subnetting.....</b>	<b>B-1</b>
<b>Appendix C</b>	<b>PPPoE.....</b>	<b>C-1</b>
<b>Appendix D</b>	<b>Setting up Your Computer's IP Address.....</b>	<b>D-1</b>
<b>Appendix E</b>	<b>Virtual Circuit Topology .....</b>	<b>E-1</b>
<b>Appendix F</b>	<b>Splitters and Microfilters .....</b>	<b>F-1</b>
<b>Appendix G</b>	<b>Power Adaptor Specifications.....</b>	<b>G-1</b>
<b>Appendix H</b>	<b>Index.....</b>	<b>H-1</b>

# List of Figures

Figure 1-1 Internet Access Application .....	1-4
Figure 1-2 LAN-to-LAN Application .....	1-4
Figure 2-1 Password Screen.....	2-1
Figure 2-2 Web Configurator SITE MAP Screen.....	2-2
Figure 2-3 Password.....	2-3
Figure 3-1 Wizard Screen 1.....	3-3
Figure 3-2 Internet Connection with PPPoA.....	3-7
Figure 3-3 Internet Connection with RFC 1483.....	3-9
Figure 3-4 Internet Connection with ENET ENCAP.....	3-10
Figure 3-5 Internet Connection with PPPoE.....	3-11
Figure 3-6 Wizard Screen 3.....	3-13
Figure 3-7 Wizard : LAN Configuration.....	3-14
Figure 3-8 Wizard Screen 4.....	3-15
Figure 4-1 LAN and WAN IP Addresses .....	4-1
Figure 4-2 LAN.....	4-4
Figure 5-1 Example of Traffic Shaping.....	5-2
Figure 5-3 WAN Setup.....	5-3
Figure 6-1 How NAT Works .....	6-2
Figure 6-2 NAT Application With IP Alias .....	6-3
Figure 6-3 Multiple Servers Behind NAT Example .....	6-7
Figure 6-4 NAT Mode.....	6-7
Figure 6-5 Edit SUA/NAT Server Set .....	6-9
Figure 6-6 Address Mapping Rules.....	6-11
Figure 6-7 Address Mapping Rule Edit.....	6-12
Figure 7-1 DDNS .....	7-2
Figure 8-1 Time and Date .....	8-1
Figure 9-1 Telnet Configuration on a TCP/IP Network .....	9-2
Figure 9-2 Remote Management.....	9-3
Figure 10-1 Configuring UPnP .....	10-2
Figure 11-1 System Status.....	11-2
Figure 11-2 System Status: Show Statistics .....	11-4
Figure 11-3 DHCP Table.....	11-6
Figure 11-4 Diagnostic.....	11-7
Figure 11-5 Diagnostic General.....	11-8
Figure 11-6 Diagnostic DSL Line .....	11-9
Figure 11-7 Firmware Upgrade.....	11-11
Figure 11-8 Network Temporarily Disconnected.....	11-12
Figure 11-9 Error Message.....	11-12
Figure 12-1 Login Screen .....	12-1

Figure 12-2 Prestige 623R-T SMT Menu Overview .....	12-2
Figure 12-3 SMT Main Menu.....	12-4
Figure 12-4 Menu 23 System Password .....	12-5
Figure 13-1 Menu 1 General Setup.....	13-2
Figure 13-2 Menu 1.1 Configure Dynamic DNS.....	13-3
Figure 14-1 Menu 3 Ethernet Setup.....	14-1
Figure 14-2 Menu 3.1 LAN Port Filter Setup.....	14-1
Figure 14-3 Menu 3.2 TCP/IP and DHCP Ethernet Setup.....	14-2
Figure 15-1 Physical Network .....	15-2
Figure 15-2 Partitioned Logical Networks.....	15-2
Figure 15-3 Menu 3.2 TCP/IP and DHCP Setup .....	15-3
Figure 15-4 Menu 3.2.1 IP Alias Setup.....	15-3
Figure 15-5 Menu 1 General Setup.....	15-4
Figure 15-6 Menu 4 Internet Access Setup.....	15-5
Figure 16-1 Menu 11 Remote Node Setup .....	16-2
Figure 16-2 Menu 11.1 Remote Node Profile.....	16-3
Figure 16-3 Menu 11.3 Remote Node Network Layer Options.....	16-7
Figure 16-4 Sample IP Addresses for a TCP/IP LAN-to-LAN Connection.....	16-9
Figure 16-5 Menu 11.5 Remote Node Filter (RFC 1483 or ENET Encapsulation).....	16-10
Figure 16-6 Menu 11.5 Remote Node Filter (PPPoA or PPPoE Encapsulation) .....	16-10
Figure 16-7 Internet Security .....	16-11
Figure 16-8 Menu 21- Filer Set Configuration .....	16-12
Figure 16-9 Menu 21.11- WebSet 11 .....	16-12
Figure 16-10 Menu 21.12- WebSet 12.....	16-12
Figure 16-11 Menu 11.6 for VC-based Multiplexing .....	16-13
Figure 16-12 Menu 11.6 for LLC-based Multiplexing or PPP Encapsulation .....	16-14
Figure 17-1 Sample Static Routing Topology.....	17-1
Figure 17-2 Menu 12 Static Route Setup.....	17-2
Figure 17-3 Menu 12.1 IP Static Route Setup .....	17-2
Figure 17-4 Menu 12.1.1 Edit IP Static Route.....	17-3
Figure 18-1 Menu 11.1 Remote Node Profile.....	18-2
Figure 18-2 Menu 11.3 Remote Node Network Layer Options.....	18-2
Figure 18-3 Menu 12.3.1 Edit Bridge Static Route .....	18-3
Figure 19-1 Menu 4 Applying NAT for Internet Access.....	19-2
Figure 19-2 Menu 11.3 Applying NAT to the Remote Node .....	19-3
Figure 19-3 Menu 15 NAT Setup.....	19-4
Figure 19-4 Menu 15.1 Address Mapping Sets.....	19-4
Figure 19-5 Menu 15.1.255 SUA Address Mapping Rules .....	19-5
Figure 19-6 Menu 15.1.2 .....	19-6
Figure 19-7 Menu 15.1.1.1 Editing/Configuring an Individual Rule in a Set.....	19-8
Figure 19-8 Menu 15.2 NAT Server Setup .....	19-9

Figure 19-9 Menu 15.2.1 NAT Server Setup.....	19-10
Figure 19-10 Multiple Servers Behind NAT Example .....	19-11
Figure 19-11 NAT Example 1 .....	19-12
Figure 19-12 Menu 4 Internet Access & NAT Example .....	19-12
Figure 19-13 NAT Example 2 .....	19-13
Figure 19-14 Menu 15.2.1 Specifying an Inside Server.....	19-13
Figure 19-15 NAT Example 3 .....	19-14
Figure 19-16 Example 3: Menu 11.3.....	19-15
Figure 19-17 Example 3: Menu 15.1.1.1 .....	19-16
Figure 19-18 Example 3: Final Menu 15.1.1 .....	19-16
Figure 19-19 NAT Example 4 .....	19-17
Figure 19-20 Example 4: Menu 15.1.1.1 Address Mapping Rule.....	19-18
Figure 19-21 Example 4: Menu 15.1.1 Address Mapping Rules .....	19-18
Figure 20-1 Outgoing Packet Filtering Process .....	20-2
Figure 20-2 Filter Rule Process.....	20-3
Figure 20-3 Menu 21 Filter Set Configuration.....	20-4
Figure 20-4 NetBIOS_WAN Filter Rules Summary .....	20-5
Figure 20-5 NetBIOS_LAN Filter Rules Summary .....	20-5
Figure 20-6 TELNET_WAN Filter Rules Summary.....	20-5
Figure 20-7 PPPoE Filter Rules Summary.....	20-6
Figure 20-8 FTP_WAN Filter Rules Summary.....	20-6
Figure 20-9 Menu 21.x.1 TCP/IP Filter Rule.....	20-8
Figure 20-10 Executing an IP Filter.....	20-11
Figure 20-11 Menu 21.6.1 Generic Filter Rule .....	20-12
Figure 20-12 Protocol and Device Filter Sets .....	20-14
Figure 20-13 Sample Telnet Filter.....	20-15
Figure 20-14 Menu 21.3.1 Sample Filter .....	20-16
Figure 20-15 Menu 21.3 Sample Filter Rules Summary.....	20-17
Figure 20-16 Filtering Ethernet Traffic .....	20-18
Figure 20-17 Filtering Remote Node Traffic .....	20-19
Figure 21-1 SNMP Management Model .....	21-1
Figure 21-2 Menu 22 SNMP Configuration.....	21-3
Figure 22-1 Menu 24 System Maintenance .....	22-1
Figure 22-2 Menu 24.1 System Maintenance : Status.....	22-2
Figure 22-3 Menu 24.2 System Information and Console Port Speed.....	22-3
Figure 22-4 Menu 24.2.1 System Maintenance : Information .....	22-4
Figure 22-5 Menu 24.2.2 System Maintenance : Change Console Port Speed.....	22-5
Figure 22-6 Menu 24.3 System Maintenance : Log and Trace .....	22-5
Figure 22-7 Sample Error and Information Messages .....	22-6
Figure 22-8 Menu 24.3.2 System Maintenance : UNIX Syslog.....	22-6
Figure 22-9 Menu 24.4 System Maintenance : Diagnostic .....	22-9

Figure 23-1 Telnet in Menu 24.5 .....	23-3
Figure 23-2 FTP Session Example.....	23-4
Figure 23-3 Telnet into Menu 24.6 .....	23-7
Figure 23-4 Restore Using FTP Session Example .....	23-8
Figure 23-5 Telnet Into Menu 24.7.1 Upload System Firmware .....	23-9
Figure 23-6 Telnet Into Menu 24.7.2 System Maintenance .....	23-9
Figure 23-7 FTP Session Example of Firmware File Upload .....	23-10
Figure 24-1 Command Mode in Menu 24 .....	24-1
Figure 24-2 Valid Commands .....	24-1
Figure 24-3 Menu 24.9 System Maintenance : Call Control .....	24-2
Figure 24-4 Menu 24.9.1 Budget Management .....	24-2
Figure 24-5 Menu 24 System Maintenance .....	24-4
Figure 24-6 Menu 24.10 System Maintenance: Time and Date Setting .....	24-4
Figure 25-1 Menu 24.11 Remote Management Control .....	25-2
Figure 26-1 Menu 25 IP Routing Policy Setup.....	26-2
Figure 26-2 Menu 25.1 IP Routing Policy Setup.....	26-3
Figure 26-3 Menu 25.1.1 IP Routing Policy .....	26-4
Figure 26-4 Menu 3.2 TCP/IP and DHCP Ethernet Setup .....	26-6
Figure 26-5 Menu 11.3 Remote Node Network Layer Options.....	26-6
Figure 26-6 Example of IP Policy Routing.....	26-7
Figure 26-7 IP Routing Policy Example .....	26-8
Figure 26-8 IP Routing Policy Example .....	26-9
Figure 26-9 Applying IP Policies Example.....	26-9
Figure 27-1 Menu 26 Schedule Setup.....	27-1
Figure 27-2 Menu 26.1 Schedule Set Setup.....	27-2
Figure 27-3 Applying Schedule Set(s) to a Remote Node (PPPoE).....	27-4



# List of Tables

Table 2-1 Password .....	2-3
Table 3-1 Wizard Screen 1 .....	3-3
Table 3-2 Internet Connection with PPPoA .....	3-7
Table 3-3 Internet Connection with RFC 1483 .....	3-9
Table 3-4 Internet Connection with ENET ENCAP .....	3-10
Table 3-5 Internet Connection with PPPoE .....	3-12
Table 3-6 Wizard : LAN Configuration .....	3-14
Table 4-1 LAN .....	4-4
Table 5-2 WAN Setup .....	5-4
Table 6-1 NAT Definitions .....	6-1
Table 6-2 NAT Mapping Types .....	6-4
Table 6-3 Services and Port Numbers .....	6-6
Table 6-4 NAT Mode .....	6-8
Table 6-5 Edit SUA/NAT Server Set .....	6-9
Table 6-6 Address Mapping Rules .....	6-11
Table 6-7 Address Mapping Rule Edit .....	6-13
Table 7-1 DDNS .....	7-2
Table 8-1 Time and Date .....	8-2
Table 9-1 Remote Management .....	9-3
Table 10-1 Configuring UPnP .....	10-2
Table 11-1 System Status .....	11-3
Table 11-2 System Status: Show Statistics .....	11-5
Table 11-3 DHCP Table .....	11-6
Table 11-4 Diagnostic General .....	11-8
Table 11-5 Diagnostic DSL Line .....	11-10
Table 11-6 Firmware Upgrade .....	11-11
Table 12-1 Main Menu Commands .....	12-3
Table 12-2 Main Menu Summary .....	12-4
Table 13-1 Menu 1 General Setup .....	13-2
Table 13-2 Menu 1.1 Configure Dynamic DNS .....	13-3
Table 14-1 DHCP Ethernet Setup Menu Fields .....	14-2
Table 14-2 TCP/IP Ethernet Setup Menu Fields .....	14-3
Table 15-1 Menu 3.2.1 IP Alias Setup .....	15-4
Table 15-2 Menu 4 Internet Access Setup .....	15-5
Table 16-1 Menu 11.1 Remote Node Profile .....	16-3
Table 16-2 Menu 11.3 Remote Node Network Layer Options .....	16-7
Table 17-1 Menu 12.1.1 Edit IP Static Route .....	17-3
Table 18-1 Menu 11.3 Remote Node Network Layer Options : Bridge Fields .....	18-3
Table 18-2 Menu 12.3.1 Edit Bridge Static Route .....	18-3

Table 19-1 Applying NAT in Menus 4 & 11.3 .....	19-3
Table 19-2 SUA Address Mapping Rules .....	19-5
Table 19-3 Menu 15.1.2 .....	19-7
Table 19-4 Menu 15.1.1.1 Editing/Configuring an Individual Rule in a Set .....	19-8
Table 20-1 Abbreviations Used in the Filter Rules Summary Menu .....	20-6
Table 20-2 Rule Abbreviations Used .....	20-7
Table 20-3 Menu 21.x.1 TCP/IP Filter Rule .....	20-9
Table 20-4 Menu 21.6.1 Generic Filter Rule .....	20-13
Table 20-5 Filter Sets Table .....	20-18
Table 21-1 Menu 22 SNMP Configuration .....	21-3
Table 21-2 SNMP Traps .....	21-4
Table 21-3 Ports and Interface Types .....	21-4
Table 22-1 Menu 24.1 System Maintenance : Status .....	22-2
Table 22-2 Menu 24.2.1 System Maintenance : Information .....	22-4
Table 22-3 Menu 24.3.2 System Maintenance : UNIX Syslog .....	22-6
Table 22-4 Menu 24.4 System Maintenance Menu : Diagnostic .....	22-9
Table 23-1 Filename Conventions .....	23-2
Table 23-2 General Commands for GUI-based FTP Clients .....	23-4
Table 23-3 General Commands for GUI-based TFTP Clients .....	23-6
Table 24-1 Menu 24.9.1 Budget Management .....	24-3
Table 24-2 Menu 24.10 System Maintenance: Time and Date Setting .....	24-5
Table 25-1 Menu 24.11 Remote Management Control .....	25-2
Table 26-1 Menu 25.1 IP Routing Policy Setup .....	26-3
Table 26-2 Menu 25.1.1 IP Routing Policy .....	26-4
Table 27-1 Menu 26.1 Schedule Set Setup .....	27-2

# List of Charts

Chart A-1 Troubleshooting Power LED.....	A-1
Chart A-2 Troubleshooting LAN LED.....	A-1
Chart A-3 Troubleshooting DSL LED.....	A-2
Chart A-4 Troubleshooting Telnet.....	A-2
Chart A-5 Troubleshooting Web Configurator.....	A-3
Chart A-6 Troubleshooting Internet Browser Display.....	A-3
Chart A-7 Troubleshooting Login Username and Password.....	A-3
Chart A-8 Troubleshooting LAN Interface.....	A-4
Chart A-9 Troubleshooting ADSL Connection.....	A-4
Chart A-10 Troubleshooting WAN Interface.....	A-5
Chart A-11 Troubleshooting Internet Access.....	A-5
Chart A-12 Troubleshooting Internet Connection.....	A-5
Chart A-13 Troubleshooting Connecting to a Remote Node or ISP.....	A-6
Chart B-1 Classes of IP Addresses.....	B-1
Chart B-2 Allowed IP Address Range By Class.....	B-2
Chart B-3 “Natural” Masks.....	B-2
Chart B-4 Alternative Subnet Mask Notation.....	B-3
Chart B-5 Subnet 1.....	B-4
Chart B-6 Subnet 2.....	B-4
Chart B-7 Subnet 1.....	B-5
Chart B-8 Subnet 2.....	B-5
Chart B-9 Subnet 3.....	B-5
Chart B-10 Subnet 4.....	B-6
Chart B-11 Eight Subnets.....	B-6
Chart B-12 Class C Subnet Planning.....	B-7
Chart B-13 Class B Subnet Planning.....	B-7

# Preface

Congratulations on your purchase from the Prestige 623R-T ADSL Dual-link Router.

Your Prestige is easy to install and configure. Use the web configurator, System Management Terminal (SMT) or command interpreter interface to configure your Prestige. Not all features can be configured through all interfaces.

**Don't forget to register your Prestige online for free future product updates and information at [www.zyxel.com](http://www.zyxel.com) for global products, or at [www.us.zyxel.com](http://www.us.zyxel.com) for North American products.**

## About This User's Guide

This manual is designed to guide you through the configuration of your Prestige for its various applications. The web configurator parts of this guide contain background information on features configurable by web configurator. The SMT parts of this guide contain background information solely on features not configurable by web configurator.

## Related Documentation

- Supporting Disk  
Refer to the included CD for support documents.
- Quick Start Guide  
The Quick Start Guide is designed to help you get up and running right away. It contains connection information and instructions on getting started.
- Web Configurator Online Help  
Embedded web help for descriptions of individual screens and supplementary information.
- ZyXEL Glossary and Web Site  
Please refer to [www.zyxel.com](http://www.zyxel.com) for an online glossary of networking terms and additional support documentation.

## Syntax Conventions

- “Enter” means for you to type one or more characters. “Select” or “Choose” means for you to use one predefined choices.
- The SMT menu titles and labels are in **Bold Times New Roman** font. Predefined field choices are in **Bold Arial** font. Command and arrow keys are enclosed in square brackets. [ENTER] means the Enter, or carriage return key; [ESC] means the Escape key and [SPACE BAR] means the Space Bar.

- Mouse action sequences are denoted using a comma. For example, “click the Apple icon, **Control Panels** and then **Modem**” means first click the Apple icon, then point your mouse pointer to **Control Panels** and then click **Modem**.
- For brevity’s sake, we will use “e.g.,” as a shorthand for “for instance”, and “i.e.,” for “that is” or “in other words” throughout this manual.
- The Prestige 623R-T may be referred to as the Prestige in this user’s guide.

**The following section offers some background information on DSL. Skip to *Chapter 1* if you wish to begin working with your router right away.**

### **User Guide Feedback**

Help us help you. E-mail all User Guide-related comments, questions or suggestions for improvement to [techwriters@zyxel.com.tw](mailto:techwriters@zyxel.com.tw) or send regular mail to The Technical Writing Team, ZyXEL Communications Corp., 6 Innovation Road II, Science-Based Industrial Park, Hsinchu, 300, Taiwan. Thank you.

# Introduction to DSL

DSL (Digital Subscriber Line) technology enhances the data capacity of the existing twisted-pair wire that runs between the local telephone company switching offices and most homes and offices. While the wire itself can handle higher frequencies, the telephone switching equipment is designed to cut off signals above 4,000 Hz to filter noise off the voice line, but now everybody is searching for ways to get more bandwidth to improve access to the Web - hence DSL technologies.

There are actually seven types of DSL service, ranging in speeds from 16 Kbits/sec to 52 Mbits/sec. The services are either symmetrical (traffic flows at the same speed in both directions), or asymmetrical (the downstream capacity is higher than the upstream capacity). Asymmetrical services (ADSL) are suitable for Internet users because more information is usually downloaded than uploaded. For example, a simple button click in a web browser can start an extended download that includes graphics and text.

As data rates increase, the carrying distance decreases. That means that users who are beyond a certain distance from the telephone company's central office may not be able to obtain the higher speeds.

A DSL connection is a point-to-point dedicated circuit, meaning that the link is always up and there is no dialing required.

## **What is ADSL?**

It is an asymmetrical technology, meaning that the downstream data rate is much higher than the upstream data rate. As mentioned, this works well for a typical Internet session in which more information is downloaded, for example, from Web servers, than is uploaded. ADSL operates in a frequency range that is above the frequency range of voice services, so the two systems can operate over the same cable.

---

---

# Part I:

---

---

## Getting Started

---

This part is structured as a step-by-step guide to help you access your Prestige. It covers key features and applications, accessing the web configurator and configuring the wizard screens for initial setup.





# Chapter 1

## Getting To Know Your Prestige

*This chapter describes the key features and applications of your Prestige.*

### 1.1 Introducing the Prestige 623R-T ADSL Dual-link Router

Your Prestige integrates a high-speed 10/100Mbps auto-negotiating LAN interface and a high-speed DSL port into a single package. The Prestige is ideal for high-speed Internet browsing and making LAN-to-LAN connections to remote networks. Provided with both USB and Ethernet ports, computers can share local resources (such as printers and files) and access to the Internet – simultaneously.

The web browser-based Graphical User Interface provides easy management.

### 1.2 Features of the Prestige

Your Prestige is packed with a number of features that give it the flexibility to provide a complete networking solution for almost any user.

#### **Ease of Installation**

Your Prestige is designed for quick, intuitive and easy installation. Physically, its compact size and lightness make it easy to position anywhere in your busy office.

#### **USB Port**

The USB port is useful if you have a USB-enabled computer that does not have a network interface card for attaching to your Ethernet network. Refer to *Quick Start Guide* for USB driver installation procedure in Windows 98 SE/Me/2000/XP.

#### **High Speed Internet Access**

The Prestige supports downstream transmission rates of up to 8Mbps and upstream transmission rates of 800 Kbps.

## **10/100Mbps Auto-negotiating Fast Ethernet LAN Interface**

This auto-negotiation feature allows the Prestige to detect the speed of incoming transmissions and adjust appropriately without manual intervention. It allows data transfer of either 10 Mbps or 100 Mbps in either half-duplex or full-duplex mode depending on your Ethernet network.

### **Protocols Supported**

- TCP/IP (Transmission Control Protocol/Internet Protocol) network layer protocol.
- PPP (Point-to-Point Protocol) link layer protocol.
- Transparent bridging for unsupported network layer protocols.
- DHCP Client, Server and Relay
- RIP I and RIP II

### **IP Policy Routing**

IP Policy Routing (IPPR) provides a mechanism to override the default routing behavior and alter the packet forwarding based on the policy defined by the network administrator.

### **Call Scheduling**

Configure call time periods to allow and restrict access to remote nodes.

### **Networking Compatibility**

Your Prestige is compatible with the major ADSL DSLAM (Digital Subscriber Line Access Multiplexer) providers, making configuration as simple as possible for you.

### **Multiplexing**

Your Prestige supports VC-based and LLC-based multiplexing.

### **Encapsulation**

The Prestige supports PPPoA (RFC 2364 - PPP over ATM Adaptation Layer 5), RFC 1483 encapsulation over ATM and MAC encapsulated routing (ENET ENCAP) as well as PPP over Ethernet (RFC 2516).

### **SNMP**

SNMP (Simple Network Management Protocol) is a protocol used for exchanging management information between network devices. SNMP is a member of the TCP/IP protocol suite. Your Prestige supports SNMP agent functionality, which allows a manager station to manage and monitor the Prestige through the network. The Prestige supports SNMP version one (SNMPv1) and version two (SNMPv2).

## Network Address Translation (NAT)

Network Address Translation (NAT) allows the translation of an Internet protocol address used within one network (for example a private IP address used in a local network) to a different IP address known within another network (for example a public IP address used on the Internet).

## Full Network Management

- SNMP (Simple Network Management Protocol) support.
- SMT (System Management Terminal) through a telnet connection.
- Web configurator.

## PAP and CHAP Security

The Prestige supports PAP (Password Authentication Protocol) and CHAP (Challenge Handshake Authentication Protocol). CHAP is more secure since the password is scrambled prior to transmission. However, PAP is readily available on more platforms.

## Filters

The Prestige's packet filtering functions allow added network security and management.

## Reset Button

The Prestige comes with a reset button built into the rear panel. Use this button to restore the factory default password to 1234, IP address to 192.168.1.1, subnet mask to 255.255.255.0 and DHCP server enabled with a pool of 32 IP addressed starting at 192.168.1.33.

# 1.3 Applications for the Prestige

Here are some example uses for which the Prestige is well suited.

## 1.3.1 Internet Access

The Prestige is the ideal high-speed Internet access solution. Your Prestige supports the TCP/IP protocol, which the Internet uses exclusively. It is compatible with all major ADSL DSLAM providers. A DSLAM is a rack of ADSL line cards with data multiplexed into a backbone network interface/connection (e.g., T1, OC3, DS3, ATM or Frame Relay). Think of it as the equivalent of a modem rack for ADSL. A typical Internet Access application is shown next.

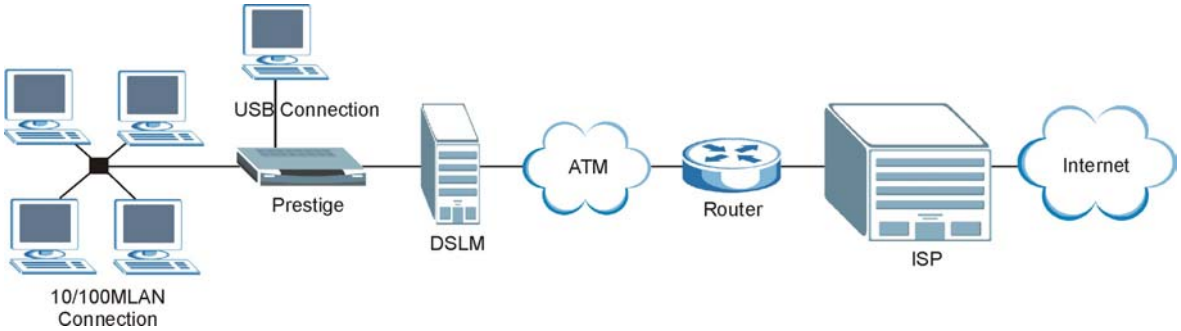

**Figure 1-1 Internet Access Application**

### 1.3.2 LAN to LAN Application

You can use the Prestige to connect two geographically dispersed networks through an ADSL line. A typical LAN-to-LAN application for your Prestige is shown as follows.

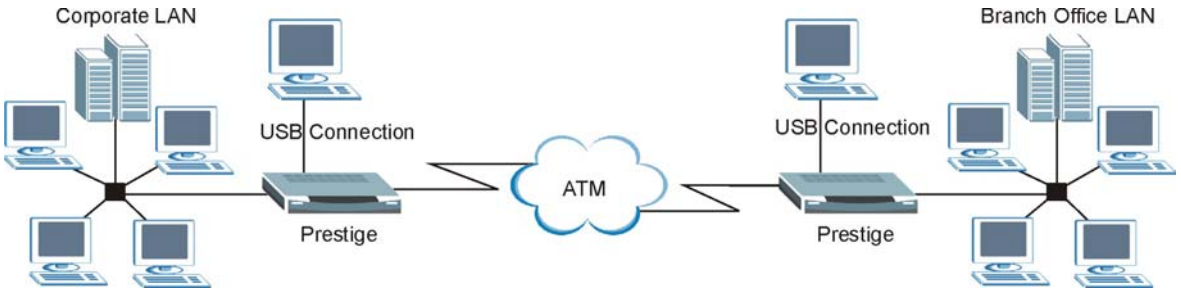

**Figure 1-2 LAN-to-LAN Application**

# Chapter 2

## Introducing the Web Configurator

*This chapter describes how to access and navigate the web configurator.*

### 2.1 Web Configurator Overview

The embedded web configurator (ewc) allows you to manage the Prestige from anywhere through a browser such as Microsoft Internet Explorer or Netscape Navigator. Use Internet Explorer 6.0 and later or Netscape Navigator 7.0 and later versions with JavaScript enabled. It is recommended that you set your screen resolution to 1024 by 768 pixels

### 2.2 Accessing the Prestige Web Configurator

- Step 1.** Make sure your Prestige hardware is properly connected (refer to Quick Start Guide).
- Step 2.** Prepare your computer/computer network to connect to the Prestige (refer to Quick Start Guide).
- Step 3.** Launch your web browser.
- Step 4.** Type "192.168.1.1" as the URL.
- Step 5.** An **Enter Network Password** window displays. Enter the user name ("admin" is the default), password ("1234" is the default) and click **OK**.



**Figure 2-1 Password Screen**

- Step 6.** You should now see the **Site Map** screen.

The Prestige automatically times out after five minutes of inactivity. Simply log back into the Prestige if this happens to you.

## 2.3 Navigating the Prestige Web Configurator

The following summarizes how to navigate the web configurator from the **Site Map** screen. Screens vary slightly for different Prestige models.

- Click **Wizard Setup** to begin a series of screens to configure your Prestige for the first time.
- Click a link under **Advanced Setup** to configure advanced Prestige features.
- Click a link under **Maintenance** to see Prestige performance statistics, upload firmware and back up, restore or upload a configuration file.
- Click **SITE MAP** to go to the **Site Map** screen.
- Click **Logout** in the navigation panel when you have finished a Prestige management session.

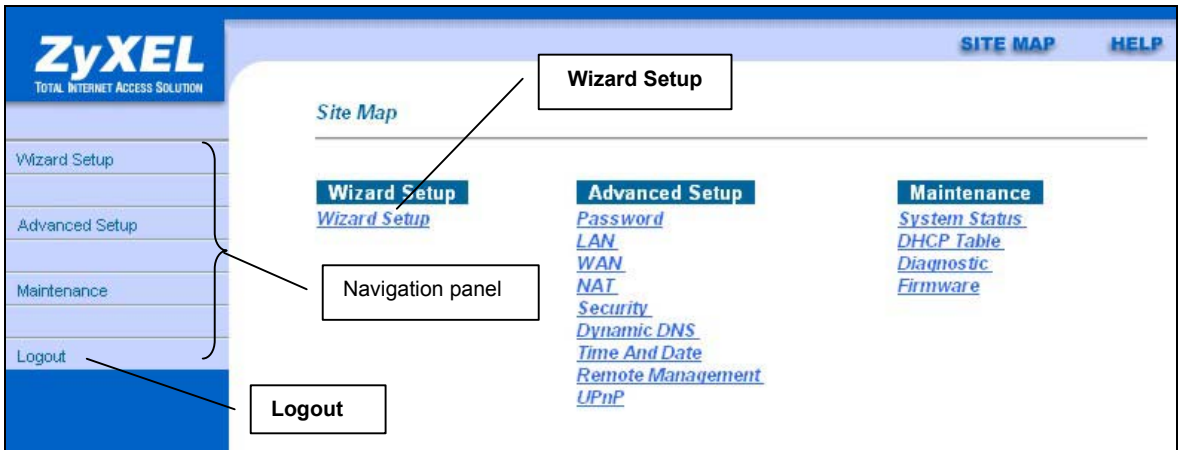

Figure 2-2 Web Configurator SITE MAP Screen

Click the **HELP** icon (located in the top right corner of most screens) to view embedded help.

## 2.4 Configuring Password

It is highly recommended that you change the password for accessing the Prestige.

To change your Prestige's password, click **Advanced Setup** and then **Password**. The screen appears as shown.

*Password*

Old Password

New Password

Retype to confirm

**Please record your new password whenever you change it. The system will lock you out if you have forgotten your password.**

**Figure 2-3 Password**

The following table describes the labels in this screen.

**Table 2-1 Password**

LABEL	DESCRIPTION
Old Password	Type the default password or the existing password you use to access the system in this field.
New Password	Type the new password in this field.
Retype to Confirm	Type the new password again in this field.
Apply	Click <b>Apply</b> to save your changes back to the Prestige.
Cancel	Click <b>Cancel</b> to reload the previous configuration for this screen.

## 2.5 Resetting the Prestige

If you forget your password or cannot access the Prestige, you will need to reload the factory-default configuration file or use the **RESET** button the back of the Prestige. Uploading this configuration file replaces the current configuration file with the factory-default configuration file. This means that you will lose all configurations that you had previously. The password will be reset to “1234”, also.

### 2.5.1 Using The Reset Button

Make sure the **PWR** LED is on (not blinking) when you begin this procedure.

1. Press the **RESET** button for more than five seconds, then release it. If the **PWR** LED begins to blink, the defaults have been restored and the Prestige restarts. Otherwise, go to step 2.
2. Turn the Prestige off.
3. While pressing the **RESET** button, turn the Prestige on.

Continue to hold the **RESET** button. The **PWR** LED will begin to blink and flicker very quickly after about 10 or 15 seconds. This indicates that the defaults have been restored and the Prestige is now restarting.



# Chapter 3

## Wizard Setup

*This chapter provides information on the Wizard Setup screens in the web configurator.*

### 3.1 Wizard Setup Introduction

Use the Wizard Setup screens to configure your system for Internet access settings and fill in the fields with the information in the *Internet Account Information* table of the *Quick Start Guide*. Your ISP may have already configured some of the fields in the wizard screens for you.

### 3.2 Encapsulation

Be sure to use the encapsulation method required by your ISP. The Prestige supports the following methods.

#### 3.2.1 ENET ENCAP

The MAC Encapsulated Routing Link Protocol (ENET ENCAP) is only implemented with the IP network protocol. IP packets are routed between the Ethernet interface and the WAN interface and then formatted so that they can be understood in a bridged environment. For instance, it encapsulates routed Ethernet frames into bridged ATM cells. ENET ENCAP requires that you specify a gateway IP address in the **Ethernet Encapsulation Gateway** field in the second wizard screen. You can get this information from your ISP.

#### 3.2.2 PPP over Ethernet

PPPoE provides access control and billing functionality in a manner similar to dial-up services using PPP. The Prestige bridges a PPP session over Ethernet (PPP over Ethernet, RFC 2516) from your computer to an ATM PVC (Permanent Virtual Circuit) which connects to ADSL Access Concentrator where the PPP session terminates. One PVC can support any number of PPP sessions from your LAN. For more information on PPPoE, see the appendix.

#### 3.2.3 PPPoA

PPPoA stands for Point to Point Protocol over ATM Adaptation Layer 5 (AAL5). It provides access control and billing functionality in a manner similar to dial-up services using PPP. The Prestige encapsulates the PPP session based on RFC1483 and sends it through an ATM PVC (Permanent Virtual Circuit) to the Internet Service Provider's (ISP) DSLAM (digital access multiplexer). Please refer to RFC 2364 for more information on PPPoA. Refer to RFC 1661 for more information on PPP.

### 3.2.4 RFC 1483

RFC 1483 describes two methods for Multiprotocol Encapsulation over ATM Adaptation Layer 5 (AAL5). The first method allows multiplexing of multiple protocols over a single ATM virtual circuit (LLC-based multiplexing) and the second method assumes that each protocol is carried over a separate ATM virtual circuit (VC-based multiplexing). Please refer to the RFC for more detailed information.

## 3.3 Multiplexing

There are two conventions to identify what protocols the virtual circuit (VC) is carrying. Be sure to use the multiplexing method required by your ISP.

### 3.3.1 VC-based Multiplexing

In this case, by prior mutual agreement, each protocol is assigned to a specific virtual circuit; for example, VCI carries IP, etc. VC-based multiplexing may be dominant in environments where dynamic creation of large numbers of ATM VCs is fast and economical.

### 3.3.2 LLC-based Multiplexing

In this case one VC carries multiple protocols with protocol identifying information being contained in each packet header. Despite the extra bandwidth and processing overhead, this method may be advantageous if it is not practical to have a separate VC for each carried protocol, for example, if charging heavily depends on the number of simultaneous VCs.

## 3.4 VPI and VCI

Be sure to use the correct Virtual Path Identifier (VPI) and Virtual Channel Identifier (VCI) numbers assigned to you. The valid range for the VPI is 0 to 255 and for the VCI is 32 to 65535 (0 to 31 is reserved for local management of ATM traffic). Please see the appendix for more information.

## 3.5 Wizard Setup Configuration: First Screen

In the **SITE MAP** screen click **Wizard Setup** to display the first wizard screen.

*Wizard Setup - ISP Parameters for Internet Access*

**Mode**                      Routing ▾

**Encapsulation**            PPPoE ▾

**Multiplex**                    LLC ▾

**Virtual Circuit ID**

    VPI                        8

    VCI                        35

Next

**Figure 3-1 Wizard Screen 1**

The following table describes the labels in this screen.

**Table 3-1 Wizard Screen 1**

LABEL	DESCRIPTION
Mode	From the <b>Mode</b> drop-down list box, select <b>Routing</b> (default) if your ISP allows multiple computers to share an Internet account. Otherwise select <b>Bridge</b> .
Encapsulation	Select the encapsulation type your ISP uses from the <b>Encapsulation</b> drop-down list box. Choices vary depending on what you select in the <b>Mode</b> field. If you select <b>Bridge</b> in the <b>Mode</b> field, select either <b>PPPoA</b> or <b>RFC 1483</b> . If you select <b>Routing</b> in the <b>Mode</b> field, select <b>PPPoA</b> , <b>RFC 1483</b> , <b>ENET ENCAP</b> or <b>PPPoE</b> .
Multiplex	Select the multiplexing method used by your ISP from the <b>Multiplex</b> drop-down list box either VC-based or LLC-based.
Virtual Circuit ID	VPI (Virtual Path Identifier) and VCI (Virtual Channel Identifier) define a virtual circuit. Refer to the appendix for more information.
VPI	Enter the VPI assigned to you. This field may already be configured.
VCI	Enter the VCI assigned to you. This field may already be configured.

**Table 3-1 Wizard Screen 1**

LABEL	DESCRIPTION
Next	Click this button to go to the next wizard screen. The next wizard screen you see depends on what protocol you chose above. Click on the protocol link to see the next wizard screen for that protocol.

## 3.6 IP Address and Subnet Mask

Similar to the way houses on a street share a common street name, so too do computers on a LAN share one common network number.

Where you obtain your network number depends on your particular situation. If the ISP or your network administrator assigns you a block of registered IP addresses, follow their instructions in selecting the IP addresses and the subnet mask.

If the ISP did not explicitly give you an IP network number, then most likely you have a single user account and the ISP will assign you a dynamic IP address when the connection is established. If this is the case, it is recommended that you select a network number from 192.168.0.0 to 192.168.255.0 and you must enable the Network Address Translation (NAT) feature of the Prestige. The Internet Assigned Number Authority (IANA) reserved this block of addresses specifically for private use; please do not use any other number unless you are told otherwise. Let's say you select 192.168.1.0 as the network number; which covers 254 individual addresses, from 192.168.1.1 to 192.168.1.254 (zero and 255 are reserved). In other words, the first three numbers specify the network number while the last number identifies an individual computer on that network.

Once you have decided on the network number, pick an IP address that is easy to remember, for instance, 192.168.1.1, for your Prestige, but make sure that no other device on your network is using that IP address.

The subnet mask specifies the network number portion of an IP address. Your Prestige will compute the subnet mask automatically based on the IP address that you entered. You don't need to change the subnet mask computed by the Prestige unless you are instructed to do otherwise.

## 3.7 IP Address Assignment

A static IP is a fixed IP that your ISP gives you. A dynamic IP is not fixed; the ISP assigns you a different one each time. The Single User Account feature can be enabled or disabled if you have either a dynamic or static IP. However the encapsulation method assigned influences your choices for IP address and ENET ENCAP Gateway.

### 3.7.1 IP Assignment with PPPoA or PPPoE Encapsulation

If you have a dynamic IP, then the IP address and ENET ENCAP Gateway fields are not applicable (N/A). If you have a static IP, then you *only* need to fill in the IP Address field and *not* the ENET ENCAP Gateway field.

### 3.7.2 IP Assignment with RFC 1483 Encapsulation

In this case the IP Address Assignment *must* be static with the same requirements for the IP Address and ENET ENCAP Gateway fields as stated above.

### 3.7.3 IP Assignment with ENET ENCAP Encapsulation

In this case you can have either a static or dynamic IP. For a static IP you must fill in all the IP Address and ENET ENCAP Gateway fields as supplied by your ISP. However for a dynamic IP, the Prestige acts as a DHCP client on the WAN port and so the IP Address and ENET ENCAP Gateway fields are not applicable (N/A) as the DHCP server assigns them to the Prestige.

### 3.7.4 Private IP Addresses

Every machine on the Internet must have a unique address. If your networks are isolated from the Internet, for example, only between your two branch offices, you can assign any IP addresses to the hosts without problems. However, the Internet Assigned Numbers Authority (IANA) has reserved the following three blocks of IP addresses specifically for private networks:

10.0.0.0        –    10.255.255.255  
172.16.0.0     –    172.31.255.255  
192.168.0.0    –    192.168.255.255

You can obtain your IP address from the IANA, from an ISP or it can be assigned from a private network. If you belong to a small organization and your Internet access is through an ISP, the ISP can provide you with the Internet addresses for your local networks. On the other hand, if you are part of a much larger organization, you should consult your network administrator for the appropriate IP addresses.

**Regardless of your particular situation, do not create an arbitrary IP address; always follow the guidelines above. For more information on address assignment, please refer to RFC 1597, *Address Allocation for Private Internets* and RFC 1466, *Guidelines for Management of IP Address Space*.**

## 3.8 Nailed-Up Connection (PPP)

A nailed-up connection is a dial-up line where the connection is always up regardless of traffic demand. The Prestige does two things when you specify a nailed-up connection. The first is that idle timeout is disabled. The second is that the Prestige will try to bring up the connection when turned on and whenever the connection is down. A nailed-up connection can be very expensive for obvious reasons.

Do not specify a nailed-up connection unless your telephone company offers flat-rate service or you need a constant connection and the cost is of no concern

## 3.9 NAT

NAT (Network Address Translation - NAT, RFC 1631) is the translation of the IP address of a host in a packet, for example, the source address of an outgoing packet, used within one network to a different IP address known within another network.

## 3.10 Wizard Setup Configuration: Second Screen

The second wizard screen varies depending on what mode and encapsulation type you use. All screens shown are with routing mode. Configure the fields and click **Next** to continue.

### 3.10.1 PPPoA

Select **PPPoA** from the **Encapsulation** drop-down list box in the first wizard screen to display the screen as shown.

**Wizard Setup - ISP Parameters for Internet Access**

---

User Name

Password

**IP Address**

Obtain an IP Address Automatically

Static IP Address

**Connection**

Connect on Demand: Max Idle Timeout  Secs

Nailed-Up Connection

**Network Address Translation**

▼

---

**Figure 3-2 Internet Connection with PPPoA**

The following table describes the labels in this screen.

**Table 3-2 Internet Connection with PPPoA**

LABEL	DESCRIPTION
User Name	Enter the user name exactly as your ISP assigned. If assigned a name in the form <a href="#">user@domain</a> where domain identifies a service name, then enter both components exactly as given.
Password	Enter the password associated with the user name above.

**Table 3-2 Internet Connection with PPPoA**

LABEL	DESCRIPTION
IP Address	<p>This option is available if you select <b>Routing</b> in the <b>Mode</b> field.</p> <p>A static IP address is a fixed IP that your ISP gives you. A dynamic IP address is not fixed; the ISP assigns you a different one each time you connect to the Internet. The Single User Account feature can be used with either a dynamic or static IP address.</p> <p>Click <b>Obtain an IP Address Automatically</b> if you have a dynamic IP address; otherwise click <b>Static IP Address</b> and type your ISP assigned IP address in the <b>IP Address</b> text box below.</p>
Connection	<p>Select <b>Connect on Demand</b> when you don't want the connection up all the time and specify an idle time-out (in seconds) in the <b>Max. Idle Timeout</b> field. The default setting selects <b>Connection on Demand</b> with 0 as the idle time-out, which means the Internet session will not timeout.</p> <p>Select <b>Nailed-Up Connection</b> when you want your connection up all the time. The Prestige will try to bring up the connection automatically if it is disconnected.</p> <p>The schedule rule(s) in SMT menu 26 has priority over your <b>Connection</b> settings.</p>
Network Address Translation	<p>This option is available if you select <b>Routing</b> in the <b>Mode</b> field.</p> <p>Select <b>None</b>, <b>SUA Only</b> or <b>Full Feature</b> from the drop-down list box. Refer to the NAT chapter for more details.</p>
Back	Click <b>Back</b> to go back to the first wizard screen.
Next	Click <b>Next</b> to continue to the next wizard screen.

### 3.10.2 RFC 1483

Select **RFC 1483** from the **Encapsulation** drop-down list box in the first wizard screen to display the screen as shown.



*Wizard Setup - ISP Parameters for Internet Access*

IP Address

**Network Address Translation**

▾

**Figure 3-3 Internet Connection with RFC 1483**

The following table describes the labels in this screen.

**Table 3-3 Internet Connection with RFC 1483**

LABEL	DESCRIPTION
IP Address	This field is available if you select <b>Routing</b> in the <b>Mode</b> field. Type your ISP assigned IP address in this field.
Network Address Translation	Select <b>None</b> , <b>SUA Only</b> or <b>Full Feature</b> from the drop-down list box. Refer to the NAT chapter for more details.
Back	Click <b>Back</b> to go back to the first wizard screen.
Next	Click <b>Next</b> to continue to the next wizard screen.

### 3.10.3 ENET ENCAP

Select **ENET ENCAP** from the **Encapsulation** drop-down list box in the first wizard screen to display the screen as shown.

*Wizard Setup - ISP Parameters for Internet Access*

**IP Address**

Obtain an IP Address Automatically  
 Static IP Address

IP Address   
 Subnet Mask   
 ENET ENCAP Gateway

**Network Address Translation**

SUA Only

Back Next

**Figure 3-4 Internet Connection with ENET ENCAP**

The following table describes the labels in this screen.

**Table 3-4 Internet Connection with ENET ENCAP**

LABEL	DESCRIPTION
IP Address	A static IP address is a fixed IP that your ISP gives you. A dynamic IP address is not fixed; the ISP assigns you a different one each time you connect to the Internet. The Single User Account feature can be used with either a dynamic or static IP address.  Select <b>Obtain an IP Address Automatically</b> if you have a dynamic IP address; otherwise select <b>Static IP Address</b> and type your ISP assigned IP address in the <b>IP Address</b> text box below.
Subnet Mask	Enter a subnet mask in dotted decimal notation.  Refer to the <i>IP Subnetting</i> appendix to calculate a subnet mask If you are implementing subnetting.
ENET ENCAP Gateway	You must specify a gateway IP address (supplied by your ISP) when you use <b>ENET ENCAP</b> in the <b>Encapsulation</b> field in the previous screen.

**Table 3-4 Internet Connection with ENET ENCAP**

LABEL	DESCRIPTION
Network Address Translation	Select <b>None</b> , <b>SUA Only</b> or <b>Full Feature</b> from the drop-down list box. Refer to the NAT chapter for more details.
Back	Click <b>Back</b> to go back to the first wizard screen.
Next	Click <b>Next</b> to continue to the next wizard screen.

### 3.10.4 PPPoE

Select **PPPoE** from the **Encapsulation** drop-down list box in the first wizard screen to display the screen as shown.

*Wizard Setup - ISP Parameters for Internet Access*

Service Name

User Name

Password

**IP Address**

Obtain an IP Address Automatically

Static IP Address

**Connection**

Connect on Demand: Max Idle Timeout  Secs

Nailed-Up Connection

**Network Address Translation**

▼

**Figure 3-5 Internet Connection with PPPoE**

The following table describes the labels in this screen.

**Table 3-5 Internet Connection with PPPoE**

LABEL	DESCRIPTION
Service Name	Type the name of your PPPoE service here.
User Name	Configure <b>User Name</b> and <b>Password</b> fields for <b>PPPoA</b> and <b>PPPoE</b> encapsulation only. Enter the user name exactly as your ISP assigned. If assigned a name in the form <a href="#">user@domain</a> where domain identifies a service name, then enter both components exactly as given.
Password	Enter the password associated with the user name above.
IP Address	<p>A static IP address is a fixed IP that your ISP gives you. A dynamic IP address is not fixed; the ISP assigns you a different one each time you connect to the Internet. The Single User Account feature can be used with either a dynamic or static IP address.</p> <p>Select <b>Obtain an IP Address Automatically</b> if you have a dynamic IP address; otherwise select <b>Static IP Address</b> and type your ISP assigned IP address in the <b>IP Address</b> text box below.</p>
Connection	<p>Select <b>Connect on Demand</b> when you don't want the connection up all the time and specify an idle time-out (in seconds) in the <b>Max. Idle Timeout</b> field. The default setting selects <b>Connection on Demand</b> with 0 as the idle time-out, which means the Internet session will not timeout.</p> <p>Select <b>Nailed-Up Connection</b> when you want your connection up all the time. The Prestige will try to bring up the connection automatically if it is disconnected.</p> <p>The schedule rule(s) in SMT menu 26 has priority over your <b>Connection</b> settings.</p>
Network Address Translation	Select <b>None</b> , <b>SUA Only</b> or <b>Full Feature</b> from the drop-down list box. Refer to the NAT chapter for more details.
Back	Click <b>Back</b> to go back to the first wizard screen.
Next	Click <b>Next</b> to continue to the next wizard screen.

### 3.11 DHCP Setup

DHCP (Dynamic Host Configuration Protocol, RFC 2131 and RFC 2132) allows individual clients to obtain TCP/IP configuration at start-up from a server. You can configure the Prestige as a DHCP server or disable it. When configured as a server, the Prestige provides the TCP/IP configuration for the clients. If you turn

DHCP service off, you must have another DHCP server on your LAN, or else the computer must be manually configured.

### 3.11.1 IP Pool Setup

The Prestige is pre-configured with a pool of 32 IP addresses starting from 192.168.1.33 to 192.168.1.64 for the client machines. This leaves 31 IP addresses, 192.168.1.2 to 192.168.1.32 (excluding the Prestige itself which has a default IP of 192.168.1.1) for other server machines, for example, server for mail, FTP, telnet, web, etc., that you may have.

## 3.12 Wizard Setup Configuration: Third Screen

Verify the settings in the screen shown next. To change the LAN information on the Prestige, click **Change LAN Configurations**. Otherwise click **Save Settings** to save the configuration and skip to section 3.13.

*Wizard Setup - ISP Parameters for Internet Access*

---

**WAN Information:**  
Mode: **Routing**  
Encapsulation: **PPPoE**  
Multiplexing: **LLC**  
VPI/VCI: **8/35**  
Service Name :  
User Name : **user@isp.ch**  
Password : **\*\*\*\*\***  
IP Address : **Obtain an IP Address Automatically**  
Network Address Translation: **SUA Only**  
Connect on Demand: **Max Idle Timeout 1500 sec.**

**LAN Information:**  
IP Address: **192.168.1.1**  
IP Mask: **255.255.255.0**  
DHCP: **ON**  
Client IP Pool Starting Address: **192.168.1.33**  
Size of Client IP Pool: **32**

---

**Figure 3-6 Wizard Screen 3**

If you want to change your Prestige LAN settings, click **Change LAN Configuration** to display the screen as shown next.

*Wizard Setup - ISP Parameters for Internet Access*

LAN IP Address: 192.168.1.1

LAN Subnet Mask: 255.255.255.0

**DHCP**

DHCP Server: ON

Client IP Pool Starting Address: 192.168.1.33

Size of Client IP Pool: 32

Primary DNS Server: 0.0.0.0

Secondary DNS Server: 0.0.0.0

Back Finish

**Figure 3-7 Wizard : LAN Configuration**

The following table describes the labels in this screen.

**Table 3-6 Wizard : LAN Configuration**

LABEL	DESCRIPTION
LAN IP Address	Enter the IP address of your Prestige in dotted decimal notation, for example, 192.168.1.1 (factory default). <div style="border: 1px solid black; background-color: #e0e0e0; padding: 5px; margin: 10px auto; width: fit-content;"> <b>If you changed the Prestige's LAN IP address, you must use the new IP address when you want to access the web configurator again.</b> </div>
LAN Subnet Mask	Enter a subnet mask in dotted decimal notation.
DHCP	
DHCP Server	From the <b>DHCP Server</b> drop-down list box, select <b>On</b> to allow your Prestige to assign IP addresses, an IP default gateway and DNS servers to computer systems that support the DHCP client. Select <b>Off</b> to disable DHCP server. <p>When DHCP server is used, set the following items:</p>

**Table 3-6 Wizard : LAN Configuration**

LABEL	DESCRIPTION
Client IP Pool Starting Address	This field specifies the first of the contiguous addresses in the IP address pool.
Size of Client IP Pool	This field specifies the size or count of the IP address pool.
Primary DNS Server	Enter the IP addresses of the DNS servers. The DNS servers are passed to the DHCP clients along with the IP address and the subnet mask.
Secondary DNS Server	As above.
Back	Click <b>Back</b> to go back to the previous screen.
Finish	Click <b>Finish</b> to save the settings and proceed to the next wizard screen.

### 3.13 Wizard Setup Configuration: Connection Tests

The Prestige automatically tests the connection to the computer(s) connected to the LAN ports. To test the connection from the Prestige to the ISP, click **Start Diagnose**. Otherwise click **Return to Main Menu** to go back to the **Site Map** screen.

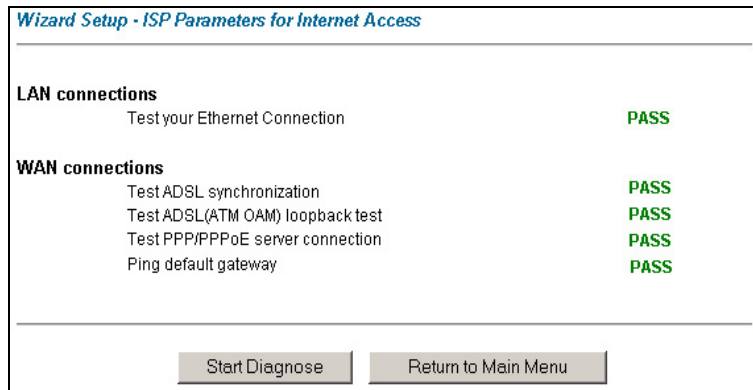
**Figure 3-8 Wizard Screen 4**

### **3.14 Test Your Internet Connection**

Launch your web browser and navigate to [www.zyxel.com](http://www.zyxel.com). Internet access is just the beginning. Refer to the rest of this *User's Guide* for more detailed information on the complete range of Prestige features. If you cannot access the Internet, open the web configurator again to confirm that the Internet settings you configured in the Wizard Setup are correct.



---

# Part II:

---

## LAN and WAN

---

This part covers LAN (Local Area Network) setup and WAN (Wide Area Network) setup.



# Chapter 4

## LAN Setup

*This chapter describes how to configure LAN settings.*

### 4.1 LAN Overview

A Local Area Network (LAN) is a shared communication system to which many computers are attached. A LAN is a computer network limited to the immediate area, usually the same building or floor of a building. The LAN screens can help you configure a LAN DHCP server and manage IP addresses.

#### 4.1.1 LANs, WANs and the Prestige

The actual physical connection determines whether the Prestige ports are LAN or WAN ports. There are two separate IP networks, one inside, the LAN network; the other outside: the WAN network as shown next:

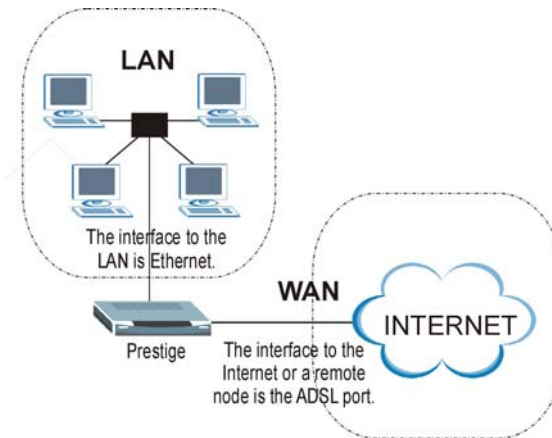

**Figure 4-1 LAN and WAN IP Addresses**

### 4.2 DNS Server Address

DNS (Domain Name System) is for mapping a domain name to its corresponding IP address and vice versa, for example, the IP address of *www.zyxel.com* is 204.217.0.2. The DNS server is extremely important because without it, you must know the IP address of a machine before you can access it. The DNS server addresses that you enter in the DHCP setup are passed to the client machines along with the assigned IP address and subnet mask.

There are two ways that an ISP disseminates the DNS server addresses. The first is for an ISP to tell a customer the DNS server addresses, usually in the form of an information sheet, when s/he signs up. If your ISP gives you the DNS server addresses, enter them in the **DNS Server** fields in **DHCP Setup**, otherwise, leave them blank.

Some ISP's choose to pass the DNS servers using the DNS server extensions of PPP IPCP (IP Control Protocol) after the connection is up. If your ISP did not give you explicit DNS servers, chances are the DNS servers are conveyed through IPCP negotiation. The Prestige supports the IPCP DNS server extensions through the DNS proxy feature.

If the **Primary** and **Secondary DNS Server** fields in **DHCP Setup** are not specified, for instance, left as 0.0.0.0, the Prestige tells the DHCP clients that it itself is the DNS server. When a computer sends a DNS query to the Prestige, the Prestige forwards the query to the real DNS server learned through IPCP and relays the response back to the computer.

Please note that DNS proxy works only when the ISP uses the IPCP DNS server extensions. It does not mean you can leave the DNS servers out of the DHCP setup under all circumstances. If your ISP gives you explicit DNS servers, make sure that you enter their IP addresses in the **DHCP Setup** menu. This way, the Prestige can pass the DNS servers to the computers and the computers can query the DNS server directly without the Prestige's intervention.

### 4.3 DNS Server Address Assignment

Use DNS (Domain Name System) to map a domain name to its corresponding IP address and vice versa. The DNS server is extremely important because without it, you must know the IP address of a computer before you can access it.

There are two ways that an ISP disseminates the DNS server addresses.

1. The ISP tells you the DNS server addresses, usually in the form of an information sheet, when you sign up. If your ISP gives you DNS server addresses, enter them in the DNS Server fields in DHCP Setup.
2. Leave the DNS Server fields in DHCP Setup blank (for example 0.0.0.0). The Prestige acts as a DNS proxy when this field is blank.

### 4.4 LAN TCP/IP

The Prestige has built-in DHCP server capability that assigns IP addresses and DNS servers to systems that support DHCP client capability.

#### 4.4.1 Factory LAN Defaults

The LAN parameters of the Prestige are preset in the factory with the following values:

- IP address of 192.168.1.1 with subnet mask of 255.255.255.0 (24 bits)
- DHCP server enabled with 32 client IP addresses starting from 192.168.1.33.

These parameters should work for the majority of installations. If your ISP gives you explicit DNS server address(es), read the embedded web configurator help regarding what fields need to be configured.

#### 4.4.2 IP Address and Subnet Mask

Refer to the *IP Address and Subnet Mask* section in the **Wizard Setup** chapter for this information.

#### 4.4.3 RIP Setup

RIP (Routing Information Protocol) allows a router to exchange routing information with other routers. The **RIP Direction** field controls the sending and receiving of RIP packets. When set to:

1. **Both** - the Prestige will broadcast its routing table periodically and incorporate the RIP information that it receives.
2. **In Only** - the Prestige will not send any RIP packets but will accept all RIP packets received.
3. **Out Only** - the Prestige will send out RIP packets but will not accept any RIP packets received.
4. **None** - the Prestige will not send any RIP packets and will ignore any RIP packets received.

The **Version** field controls the format and the broadcasting method of the RIP packets that the Prestige sends (it recognizes both formats when receiving). **RIP-1** is universally supported; but RIP-2 carries more information. RIP-1 is probably adequate for most networks, unless you have an unusual network topology.

Both **RIP-2B** and **RIP-2M** sends the routing data in RIP-2 format; the difference being that **RIP-2B** uses subnet broadcasting while **RIP-2M** uses multicasting.

#### 4.4.4 Multicast

Traditionally, IP packets are transmitted in one of either two ways - Unicast (1 sender - 1 recipient) or Broadcast (1 sender - everybody on the network). Multicast delivers IP packets to a group of hosts on the network - not everybody and not just 1.

IGMP (Internet Group Multicast Protocol) is a network-layer protocol used to establish membership in a Multicast group - it is not used to carry user data. IGMP version 2 (RFC 2236) is an improvement over version 1 (RFC 1112) but IGMP version 1 is still in wide use. If you would like to read more detailed information about interoperability between IGMP version 2 and version 1, please see sections 4 and 5 of RFC 2236. The class D IP address is used to identify host groups and can be in the range 224.0.0.0 to 239.255.255.255. The address 224.0.0.0 is not assigned to any group and is used by IP multicast computers. The address 224.0.0.1 is used for query messages and is assigned to the permanent group of all IP hosts (including gateways). All hosts must join the 224.0.0.1 group in order to participate in IGMP. The address 224.0.0.2 is assigned to the multicast routers group.

The Prestige supports both IGMP version 1 (**IGMP-v1**) and IGMP version 2 (**IGMP-v2**). At start up, the Prestige queries all directly connected networks to gather group membership. After that, the Prestige periodically updates this information. IP multicasting can be enabled/disabled on the Prestige LAN and/or WAN interfaces in the web configurator (**LAN**; **WAN**). Select **None** to disable IP multicasting on these interfaces.

## 4.5 Configuring LAN

Click **LAN** to open the following screen.

**LAN - Setup**

---

**DHCP**

DHCP Server ▾

Client IP Pool Starting Address

Size of Client IP Pool

Primary DNS Server

Secondary DNS Server

Remote DHCP Server

**TCP/IP**

IP Address

IP Subnet Mask

RIP Direction None ▾

RIP Version N/A ▾

Multicast None ▾

---

**Figure 4-2 LAN**

The following table describes the labels in this screen.

**Table 4-1 LAN**

LABEL	DESCRIPTION
DHCP	

Table 4-1 LAN

LABEL	DESCRIPTION
DHCP	<p>If set to <b>Server</b>, your Prestige can assign IP addresses, an IP default gateway and DNS servers to Windows 95, Windows NT and other systems that support the DHCP client.</p> <p>If set to <b>None</b>, the DHCP server will be disabled.</p> <p>If set to <b>Relay</b>, the Prestige acts as a surrogate DHCP server and relays DHCP requests and responses between the remote server and the clients. Enter the IP address of the actual, remote DHCP server in the Remote DHCP Server field in this case.</p> <p>When DHCP is used, the following items need to be set:</p>
Client IP Pool Starting Address	This field specifies the first of the contiguous addresses in the IP address pool.
Size of Client IP Pool	This field specifies the size or count of the IP address pool.
Primary DNS Server	Enter the IP addresses of the DNS servers. The DNS servers are passed to the DHCP clients along with the IP address and the subnet mask.
Secondary DNS Server	As above.
Remote DHCP Server	If <b>Relay</b> is selected in the <b>DHCP</b> field above then enter the IP address of the actual remote DHCP server here.
TCP/IP	
IP Address	Enter the IP address of your Prestige in dotted decimal notation, for example, 192.168.1.1 (factory default).
IP Subnet Mask	Type the subnet mask assigned to you by your ISP (if given).
RIP Direction	Select the RIP direction from <b>None</b> , <b>Both</b> , <b>In Only</b> and <b>Out Only</b> .
RIP Version	Select the RIP version from <b>RIP-1</b> , <b>RIP-2B</b> and <b>RIP-2M</b> .
Multicast	IGMP (Internet Group Multicast Protocol) is a session-layer protocol used to establish membership in a multicast group. The Prestige supports both IGMP version 1 ( <b>IGMP-v1</b> ) and <b>IGMP-v2</b> . Select <b>None</b> to disable it.
Apply	Click <b>Apply</b> to save your changes back to the Prestige.
Cancel	Click <b>Cancel</b> to reload the previous configuration for this screen.





# Chapter 5

## WAN Setup

*This chapter describes how to configure WAN settings.*

### 5.1 WAN Overview

A WAN (Wide Area Network) is an outside connection to another network or the Internet. See the *Wizard Setup* chapter for more information on the fields in the WAN screens.

### 5.2 PPPoE Encapsulation

The Prestige supports PPPoE (Point-to-Point Protocol over Ethernet). PPPoE is an IETF Draft standard (RFC 2516) specifying how a personal computer (PC) interacts with a broadband modem (DSL, cable, wireless, etc.) connection. The **PPPoE** option is for a dial-up connection using PPPoE.

For the service provider, PPPoE offers an access and authentication method that works with existing access control systems (for example Radius). PPPoE provides a login and authentication method that the existing Microsoft Dial-Up Networking software can activate, and therefore requires no new learning or procedures for Windows users.

One of the benefits of PPPoE is the ability to let you access one of multiple network services, a function known as dynamic service selection. This enables the service provider to easily create and offer new IP services for individuals.

Operationally, PPPoE saves significant effort for both you and the ISP or carrier, as it requires no specific configuration of the broadband modem at the customer site.

By implementing PPPoE directly on the Prestige (rather than individual computers), the computers on the LAN do not need PPPoE software installed, since the Prestige does that part of the task. Furthermore, with NAT, all of the LANs' computers will have access.

### 5.3 PPTP Encapsulation

Point-to-Point Tunneling Protocol (PPTP) is a network protocol that enables secure transfer of data from a remote client to a private server, creating a Virtual Private Network (VPN) using TCP/IP-based networks. PPTP supports on-demand, multi-protocol and virtual private networking over public networks, such as the Internet.

## 5.4 Traffic Shaping

Traffic Shaping is an agreement between the carrier and the subscriber to regulate the average rate and fluctuations of data transmission over an ATM network. This agreement helps eliminate congestion, which is important for transmission of real time data such as audio and video connections.

Peak Cell Rate (PCR) is the maximum rate at which the sender can send cells. This parameter may be lower (but not higher) than the maximum line speed. 1 ATM cell is 53 bytes (424 bits), so a maximum speed of 832Kbps gives a maximum PCR of 1962 cells/sec. This rate is not guaranteed because it is dependent on the line speed.

Sustained Cell Rate (SCR) is the mean cell rate of each bursty traffic source. It specifies the maximum average rate at which cells can be sent over the virtual connection. SCR may not be greater than the PCR.

Maximum Burst Size (MBS) is the maximum number of cells that can be sent at the PCR. After MBS is reached, cell rates fall below SCR until cell rate averages to the SCR again. At this time, more cells (up to the MBS) can be sent at the PCR again.

**If the PCR, SCR or MBS is set to the default of "0", the system will assign a maximum value that correlates to your upstream line rate.**

The following figure illustrates the relationship between PCR, SCR and MBS.

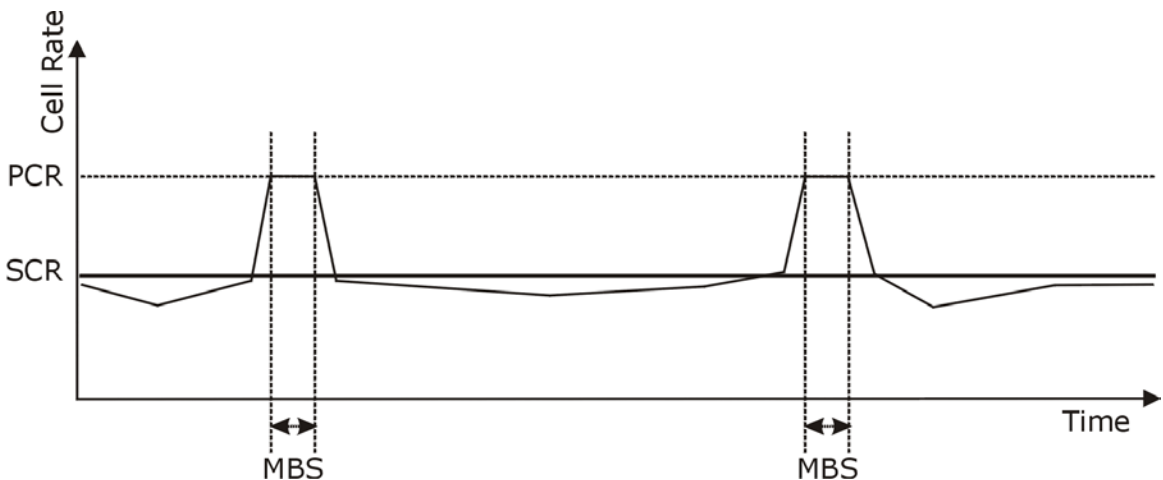

**Figure 5-1 Example of Traffic Shaping**

## 5.5 WAN Setup

To change your Prestige's WAN remote node settings, click **WAN** and then **WAN Setup**. The screen differs by the encapsulation.

**WAN - WAN Setup**

---

**Name**

**Mode**

**Encapsulation**

**Multiplex**

**Virtual Circuit ID**

  VPI

  VCI

**ATM QoS Type**

**Cell Rate**

  Peak Cell Rate  cell/sec

  Sustain Cell Rate  cell/sec

  Maximum Burst Size

**Login Information**

  Service Name

  User Name

  Password

**IP Address**

Obtain an IP Address Automatically

Static IP Address

  IP Address

**Connection**

Nailed-Up Connection

Connect on Demand

  Max Idle Timeout  sec

---

**Figure 5-2 WAN Setup**

The following table describes the labels in this screen.

**Table 5-1 WAN Setup**

LABEL	DESCRIPTION
Name	Enter the name of your Internet Service Provider, e.g., MyISP. This information is for identification purposes only.
Active	Select <b>Yes</b> to enable this profile.
Mode	Select <b>Routing</b> (default) from the drop-down list box if your ISP allows multiple computers to share an Internet account. Otherwise select <b>Bridge</b> .
Encapsulation	Select the method of encapsulation used by your ISP from the drop-down list box. Choices vary depending on the mode you select in the <b>Mode</b> field. If you select <b>Bridge</b> in the <b>Mode</b> field, select either <b>PPPoA</b> or <b>RFC 1483</b> . If you select <b>Routing</b> in the <b>Mode</b> field, select <b>PPPoA</b> , <b>RFC 1483</b> , <b>ENET ENCAP</b> or <b>PPPoE</b> .
Multiplex	Select the method of multiplexing used by your ISP from the drop-down list. Choices are <b>VC</b> or <b>LLC</b> .
Virtual Circuit ID	VPI (Virtual Path Identifier) and VCI (Virtual Channel Identifier) define a virtual circuit. Refer to the appendix for more information.
VPI	The valid range for the VPI is 0 to 255. Enter the VPI assigned to you.
VCI	The valid range for the VCI is 32 to 65535 (0 to 31 is reserved for local management of ATM traffic). Enter the VCI assigned to you.
ATM QoS Type	Select <b>CBR</b> (Continuous Bit Rate) to specify fixed (always-on) bandwidth for voice or data traffic. Select <b>UBR</b> (Unspecified Bit Rate) for applications that are non-time sensitive, such as e-mail. Select <b>VBR</b> (Variable Bit Rate) for bursty traffic and bandwidth sharing with other applications. <b>VBR</b> is not available on all models.
Cell Rate	Cell rate configuration often helps eliminate traffic congestion that slows transmission of real time data such as audio and video connections.
Peak Cell Rate	Divide the DSL line rate (bps) by 424 (the size of an ATM cell) to find the Peak Cell Rate (PCR). This is the maximum rate at which the sender can send cells. Type the PCR here.

Table 5-1 WAN Setup

LABEL	DESCRIPTION
Sustain Cell Rate	The Sustain Cell Rate (SCR) sets the average cell rate (long-term) that can be transmitted. Type the SCR, which must be less than the PCR.
Maximum Burst Size	Maximum Burst Size (MBS) refers to the maximum number of cells that can be sent at the peak rate. Type the MBS, which is less than 65535.
Login Information	(PPPoA and PPPoE encapsulation only)
Service Name	(PPPoE only) Type the name of your PPPoE service here.
User Name	Enter the user name exactly as your ISP assigned. If assigned a name in the form <a href="#">user@domain</a> where domain identifies a service name, then enter both components exactly as given.
Password	Enter the password associated with the user name above.
IP Address	<p>This option is available if you select <b>Routing</b> in the <b>Mode</b> field.</p> <p>A static IP address is a fixed IP. A dynamic IP address is not fixed; the ISP assigns you a different one each time you connect to the Internet.</p> <p>Select <b>Obtain an IP Address Automatically</b> if you have a dynamic IP address. This option is not available for remote node setup.</p> <p>Select <b>Static IP Address</b> and set the fields below.</p>
IP Address	<p>Enter the static IP address provided.</p> <p style="text-align: center;"><b>For remote node setup, enter the IP address in the same subnet as the remote node.</b></p>
Subnet Mask	<p>Enter a subnet mask in dotted decimal notation.</p> <p>Refer to the <i>Subnetting</i> appendix in the to calculate a subnet mask If you are implementing subnetting.</p> <p style="text-align: center;"><b>For remote node setup, enter the remote node's subnet mask.</b></p>

**Table 5-1 WAN Setup**

<b>LABEL</b>	<b>DESCRIPTION</b>
ENET ENCAP Gateway	You must specify a gateway IP address (supplied by your ISP).
Connection (PPPoA and PPPoE encapsulation only)	The schedule rule(s) in SMT menu 26 have priority over your <b>Connection</b> settings.
Nailed-Up Connection	Select <b>Nailed-Up Connection</b> when you want your connection up all the time. The Prestige will try to bring up the connection automatically if it is disconnected.
Connect on Demand	Select <b>Connect on Demand</b> when you don't want the connection up all the time and specify an idle time-out in the <b>Max Idle Timeout</b> field.
Max Idle Timeout	Specify an idle time-out in the <b>Max Idle Timeout</b> field when you select <b>Connect on Demand</b> . The default setting is 0, which means the Internet session will not timeout.
Back	Click <b>Back</b> to return to the previous screen.
Apply	Click <b>Apply</b> to save the changes.
Cancel	Click <b>Cancel</b> to begin configuring this screen afresh.

---

# Part III:

---

## NAT, Dynamic DNS and Time and Date

---

This part covers NAT (Network Address Translation), dynamic DNS (Domain Name Server) and Time and Date setup.





# Chapter 6

## Network Address Translation (NAT)

*This chapter discusses how to configure NAT on the Prestige.*

### 6.1 NAT Overview

NAT (Network Address Translation - NAT, RFC 1631) is the translation of the IP address of a host in a packet, for example, the source address of an outgoing packet, used within one network to a different IP address known within another network.

#### 6.1.1 NAT Definitions

Inside/outside denotes where a host is located relative to the Prestige, for example, the computers of your subscribers are the inside hosts, while the web servers on the Internet are the outside hosts.

Global/local denotes the IP address of a host in a packet as the packet traverses a router, for example, the local address refers to the IP address of a host when the packet is in the local network, while the global address refers to the IP address of the host when the same packet is traveling in the WAN side.

Note that inside/outside refers to the location of a host, while global/local refers to the IP address of a host used in a packet. Thus, an inside local address (ILA) is the IP address of an inside host in a packet when the packet is still in the local network, while an inside global address (IGA) is the IP address of the same inside host when the packet is on the WAN side. The following table summarizes this information.

**Table 6-1 NAT Definitions**

ITEM	DESCRIPTION
Inside	This refers to the host on the LAN.
Outside	This refers to the host on the WAN.
Local	This refers to the packet address (source or destination) as the packet travels on the LAN.
Global	This refers to the packet address (source or destination) as the packet travels on the WAN.

**NAT never changes the IP address (either local or global) of an outside host.**

#### 6.1.2 What NAT Does

In the simplest form, NAT changes the source IP address in a packet received from a subscriber (the inside local address) to another (the inside global address) before forwarding the packet to the WAN side. When the response comes back, NAT translates the destination address (the inside global address) back to the inside

local address before forwarding it to the original inside host. Note that the IP address (either local or global) of an outside host is never changed.

The global IP addresses for the inside hosts can be either static or dynamically assigned by the ISP. In addition, you can designate servers, for example, a web server and a telnet server, on your local network and make them accessible to the outside world. With no servers defined, your Prestige filters out all incoming inquiries, thus preventing intruders from probing your network. For more information on IP address translation, refer to *RFC 1631, The IP Network Address Translator (NAT)*.

### 6.1.3 How NAT Works

Each packet has two addresses – a source address and a destination address. For outgoing packets, the ILA (Inside Local Address) is the source address on the LAN, and the IGA (Inside Global Address) is the source address on the WAN. For incoming packets, the ILA is the destination address on the LAN, and the IGA is the destination address on the WAN. NAT maps private (local) IP addresses to globally unique ones required for communication with hosts on other networks. It replaces the original IP source address (and TCP or UDP source port numbers for Many-to-One and Many-to-Many Overload NAT mapping) in each packet and then forwards it to the Internet. The Prestige keeps track of the original addresses and port numbers so incoming reply packets can have their original values restored. The following figure illustrates this.

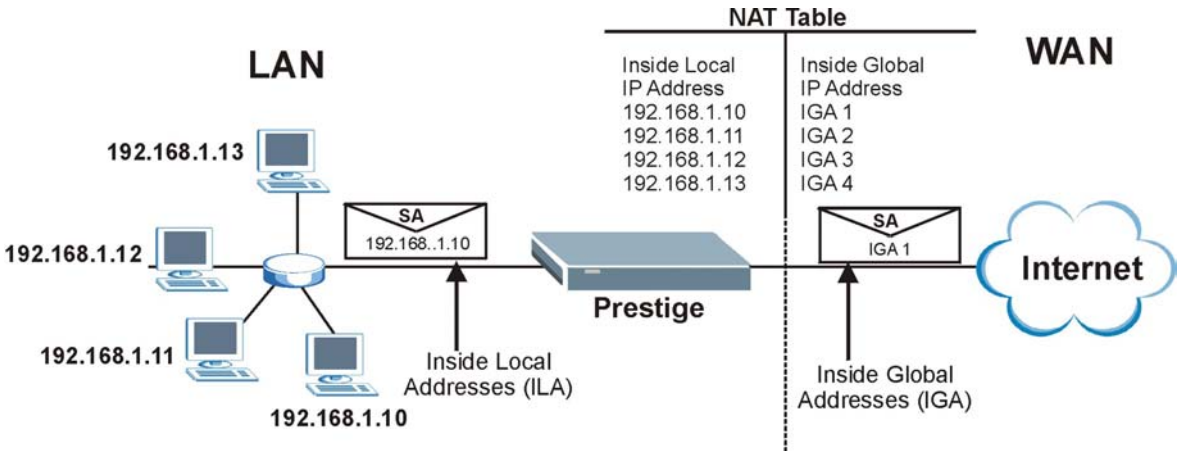

Figure 6-1 How NAT Works

### 6.1.4 NAT Application

The following figure illustrates a possible NAT application, where three inside LANs (logical LANs using IP Alias) behind the Prestige can communicate with three distinct WAN networks. More examples follow at the end of this chapter.

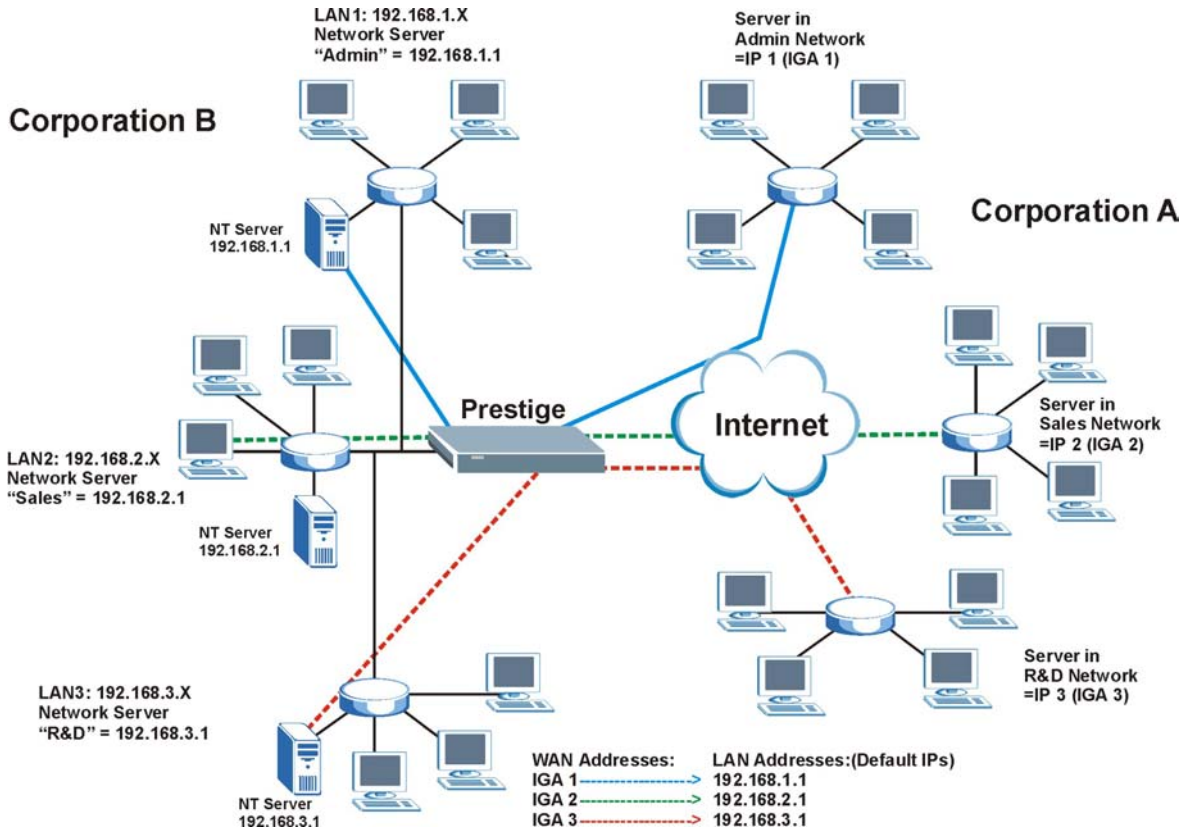

Figure 6-2 NAT Application With IP Alias

### 6.1.5 NAT Mapping Types

NAT supports five types of IP/port mapping. They are:

1. **One to One:** In One-to-One mode, the Prestige maps one local IP address to one global IP address.
2. **Many to One:** In Many-to-One mode, the Prestige maps multiple local IP addresses to one global IP address. This is equivalent to SUA (for instance, PAT, port address translation), ZyXEL's Single User Account feature that previous ZyXEL routers supported (the **SUA Only** option in today's routers).
3. **Many to Many Overload:** In Many-to-Many Overload mode, the Prestige maps the multiple local IP addresses to shared global IP addresses.
4. **Many-to-Many No Overload:** In Many-to-Many No Overload mode, the Prestige maps each local IP address to a unique global IP address.

5. **Server**: This type allows you to specify inside servers of different services behind the NAT to be accessible to the outside world.

**Port numbers do not change for One-to-One and Many-to-Many No Overload NAT mapping types.**

The following table summarizes these types.

**Table 6-2 NAT Mapping Types**

TYPE	IP MAPPING	SMT ABBREVIATION
One-to-One	ILA1 ↔ IGA1	1:1
Many-to-One (SUA/PAT)	ILA1 ↔ IGA1 ILA2 ↔ IGA1 ...	M:1
Many-to-Many Overload	ILA1 ↔ IGA1 ILA2 ↔ IGA2 ILA3 ↔ IGA1 ILA4 ↔ IGA2 ...	M:M Ov
Many-to-Many No Overload	ILA1 ↔ IGA1 ILA2 ↔ IGA2 ILA3 ↔ IGA3 ...	M:M No OV
Server	Server 1 IP ↔ IGA1 Server 2 IP ↔ IGA1 Server 3 IP ↔ IGA1	Server

## 6.2 SUA (Single User Account) Versus NAT

SUA (Single User Account) is a Zynos implementation of a subset of NAT that supports two types of mapping, **Many-to-One** and **Server**. The Prestige also supports **Full Feature** NAT to map multiple global IP addresses to multiple private LAN IP addresses of clients or servers using mapping types as outlined in *Table 6-2*.

1. **Choose SUA Only if you have just one public WAN IP address for your Prestige.**
2. **Choose Full Feature if you have multiple public WAN IP addresses for your Prestige.**

## 6.3 SUA Server

A SUA server set is a list of inside (behind NAT on the LAN) servers, for example, web or FTP, that you can make visible to the outside world even though SUA makes your whole inside network appear as a single computer to the outside world.

You may enter a single port number or a range of port numbers to be forwarded, and the local IP address of the desired server. The port number identifies a service; for example, web service is on port 80 and FTP on port 21. In some cases, such as for unknown services or where one server can support more than one service (for example both FTP and web service), it might be better to specify a range of port numbers. You can allocate a server IP address that corresponds to a port or a range of ports.

Many residential broadband ISP accounts do not allow you to run any server processes (such as a Web or FTP server) from your location. Your ISP may periodically check for servers and may suspend your account if it discovers any active services at your location. If you are unsure, refer to your ISP.

### Default Server IP Address

In addition to the servers for specified services, NAT supports a default server IP address. A default server receives packets from ports that are not specified in this screen.

**If you do not assign an IP address in Server Set 1 (default server), the Prestige discards all packets received for ports that are not specified here or in the remote management setup.**

### 6.3.1 Port Forwarding: Services and Port Numbers

A NAT server set is a list of inside (behind NAT on the LAN) servers, for example, web or FTP, that you can make accessible to the outside world even though NAT makes your whole inside network appear as a single machine to the outside world.

Use the **SUA Server** page to forward incoming service requests to the server(s) on your local network. You may enter a single port number or a range of port numbers to be forwarded, and the local IP address of the desired server. The port number identifies a service; for example, web service is on port 80 and FTP on port 21. In some cases, such as for unknown services or where one server can support more than one service (for example both FTP and web service), it might be better to specify a range of port numbers.

In addition to the servers for specified services, NAT supports a default server. A service request that does not have a server explicitly designated for it is forwarded to the default server. If the default is not defined, the service request is simply discarded.

**Many residential broadband ISP accounts do not allow you to run any server processes (such as a Web or FTP server) from your location. Your ISP may periodically check for servers and may suspend your account if it discovers any active services at your location. If you are unsure, refer to your ISP.**

The most often used port numbers are shown in the following table. Please refer to RFC 1700 for further information about port numbers.

**Table 6-3 Services and Port Numbers**

SERVICES	PORT NUMBER
ECHO	7
FTP (File Transfer Protocol)	21
SMTP (Simple Mail Transfer Protocol)	25
DNS (Domain Name System)	53
Finger	79
HTTP (Hyper Text Transfer protocol or WWW, Web)	80
POP3 (Post Office Protocol)	110
NNTP (Network News Transport Protocol)	119
SNMP (Simple Network Management Protocol)	161
SNMP trap	162
PPTP (Point-to-Point Tunneling Protocol)	1723

### 6.3.2 Configuring Servers Behind SUA (Example)

Let's say you want to assign ports 22-25 to one server, port 80 to another and assign a default server IP address of 192.168.1.35 as shown in the next figure.

Private Network IP address assigned by user

The NAT network appears as a single host on the Internet

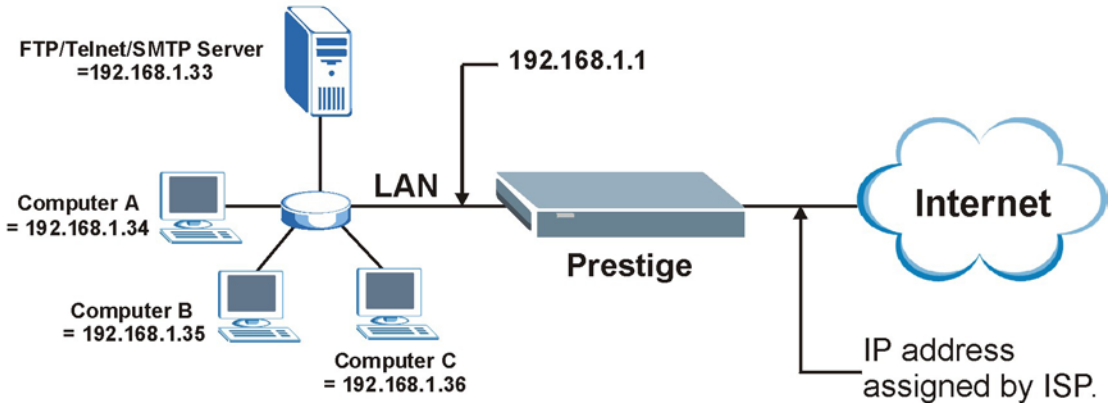

Figure 6-3 Multiple Servers Behind NAT Example

## 6.4 Selecting the NAT Mode

Click NAT to open the following screen.

***NAT - Mode***

---

Network Address Translation

None  
 SUA Only [Edit Details](#)  
 Full Feature [Edit Details](#)

---

Figure 6-4 NAT Mode

The following table describes the labels in this screen.

**Table 6-4 NAT Mode**

<b>LABEL</b>	<b>DESCRIPTION</b>
None	Select this radio button to disable NAT.
SUA Only	Select this radio button if you have just one public WAN IP address for your Prestige. The Prestige uses Address Mapping Set 1 in the <b>NAT - Edit SUA/NAT Server Set</b> screen.
Edit Details	Click this link to go to the <b>NAT - Edit SUA/NAT Server Set</b> screen.
Full Feature	Select this radio button if you have multiple public WAN IP addresses for your Prestige.
Edit Details	Click this link to go to the <b>NAT - Address Mapping Rules</b> screen.
Apply	Click <b>Apply</b> to save your configuration.

## 6.5 Configuring SUA Server

**If you do not assign an IP address in Server Set 1 (default server), the Prestige discards all packets received for ports that are not specified here or in the remote management setup.**

Click **NAT**, Select **SUA Only** and click **Edit Details** to open the following screen.



*NAT - Edit SUA/NAT Server Set*

	Start Port No.	End Port No.	IP Address
1	All ports	All ports	0.0.0.0
2	<input type="text"/>	<input type="text"/>	0.0.0.0
3	<input type="text"/>	<input type="text"/>	0.0.0.0
4	<input type="text"/>	<input type="text"/>	0.0.0.0
5	<input type="text"/>	<input type="text"/>	0.0.0.0
6	<input type="text"/>	<input type="text"/>	0.0.0.0
7	<input type="text"/>	<input type="text"/>	0.0.0.0
8	<input type="text"/>	<input type="text"/>	0.0.0.0
9	<input type="text"/>	<input type="text"/>	0.0.0.0
10	<input type="text"/>	<input type="text"/>	0.0.0.0
11	<input type="text"/>	<input type="text"/>	0.0.0.0
12	<input type="text"/>	<input type="text"/>	0.0.0.0

Save Cancel

**Figure 6-5 Edit SUA/NAT Server Set**

The following table describes the labels in this screen.

**Table 6-5 Edit SUA/NAT Server Set**

LABEL	DESCRIPTION
Start Port No.	Enter a port number in this field. To forward only one port, enter the port number again in the <b>End Port No.</b> field. To forward a series of ports, enter the start port number here and the end port number in the <b>End Port No.</b> field.

**Table 6-5 Edit SUA/NAT Server Set**

LABEL	DESCRIPTION
End Port No.	Enter a port number in this field. To forward only one port, enter the port number again in the <b>Start Port No.</b> field above and then enter it again in this field. To forward a series of ports, enter the last port number in a series that begins with the port number in the <b>Start Port No.</b> field above.
IP Address	Enter your server IP address in this field.
Save	Click <b>Save</b> to save your changes back to the Prestige.
Cancel	Click <b>Cancel</b> to return to the previous configuration.

## 6.6 Configuring Address Mapping

Ordering your rules is important because the Prestige applies the rules in the order that you specify. When a rule matches the current packet, the Prestige takes the corresponding action and the remaining rules are ignored. If there are any empty rules before your new configured rule, your configured rule will be pushed up by that number of empty rules. For example, if you have already configured rules 1 to 6 in your current set and now you configure rule number 9. In the set summary screen, the new rule will be rule 7, not 9. Now if you delete rule 4, rules 5 to 7 will be pushed up by 1 rule, so old rules 5, 6 and 7 become new rules 4, 5 and 6.

To change your Prestige's address mapping settings, click **NAT**, select **Full Feature** and click **Edit Details** to open the following screen.

**NAT - Address Mapping Rules**

	Local Start IP	Local End IP	Global Start IP	Global End IP	Type
<a href="#">Rule 1</a>	...	...	...	...	-
<a href="#">Rule 2</a>	...	...	...	...	-
<a href="#">Rule 3</a>	...	...	...	...	-
<a href="#">Rule 4</a>	...	...	...	...	-
<a href="#">Rule 5</a>	...	...	...	...	-
<a href="#">Rule 6</a>	...	...	...	...	-
<a href="#">Rule 7</a>	...	...	...	...	-
<a href="#">Rule 8</a>	...	...	...	...	-
<a href="#">Rule 9</a>	...	...	...	...	-
<a href="#">Rule 10</a>	...	...	...	...	-

Back

**Figure 6-6 Address Mapping Rules**

The following table describes the labels in this screen.

**Table 6-6 Address Mapping Rules**

LABEL	DESCRIPTION
Local Start IP	This is the starting Inside Local IP Address (ILA). Local IP addresses are <b>N/A</b> for <b>Server</b> port mapping.
Local End IP	This is the end Inside Local IP Address (ILA). If your rule is for all local IP addresses, then enter 0.0.0.0 as the <b>Local Start IP</b> address and 255.255.255.255 as the <b>Local End IP</b> address. This field is <b>N/A</b> for <b>One-to-one</b> and <b>Server</b> mapping types.
Global Start IP	This is the starting Inside Global IP Address (IGA). Enter 0.0.0.0 here if you have a dynamic IP address from your ISP. You can only do this for <b>Many-to-One</b> and <b>Server</b> mapping types.
Global End IP	This is the ending Inside Global IP Address (IGA). This field is <b>N/A</b> for <b>One-to-one</b> , <b>Many-to-One</b> and <b>Server</b> mapping types.

**Table 6-6 Address Mapping Rules**

LABEL	DESCRIPTION
Type	<p><b>1-1:</b> One-to-one mode maps one local IP address to one global IP address. Note that port numbers do not change for the One-to-one NAT mapping type.</p> <p><b>M-1:</b> Many-to-One mode maps multiple local IP addresses to one global IP address. This is equivalent to SUA (i.e., PAT, port address translation), ZyXEL's Single User Account feature that previous ZyXEL routers supported only.</p> <p><b>M-M Ov</b> (Overload): Many-to-Many Overload mode maps multiple local IP addresses to shared global IP addresses.</p> <p><b>MM No</b> (No Overload): Many-to-Many No Overload mode maps each local IP address to unique global IP addresses.</p> <p><b>Server:</b> This type allows you to specify inside servers of different services behind the NAT to be accessible to the outside world.</p>
Back	Click <b>Back</b> to return to the <b>NAT Mode</b> screen.

## 6.7 Editing an Address Mapping Rule

To edit an address mapping rule, click the rule's link in the **NAT Address Mapping Rules** screen to display the screen shown next.

***NAT - Edit Address Mapping Rule 1***

---

Type

Local Start IP

Local End IP

Global Start IP

Global End IP

Server Mapping Set  [Edit Details](#)

---

**Figure 6-7 Address Mapping Rule Edit**

The following table describes the labels in this screen.

**Table 6-7 Address Mapping Rule Edit**

LABEL	DESCRIPTION
Type	<p>Choose the port mapping type from one of the following.</p> <ol style="list-style-type: none"> <li>1. <b>One-to-One</b>: One-to-One mode maps one local IP address to one global IP address. Note that port numbers do not change for One-to-one NAT mapping type.</li> <li>2. <b>Many-to-One</b>: Many-to-One mode maps multiple local IP addresses to one global IP address. This is equivalent to SUA (i.e., PAT, port address translation), ZyXEL's Single User Account feature that previous ZyXEL routers supported only.</li> <li>3. <b>Many-to-Many Overload</b>: Many-to-Many Overload mode maps multiple local IP addresses to shared global IP addresses.</li> <li>4. <b>Many-to-Many No Overload</b>: Many-to-Many No Overload mode maps each local IP address to unique global IP addresses.</li> <li>5. <b>Server</b>: This type allows you to specify inside servers of different services behind the NAT to be accessible to the outside world.</li> </ol>
Local Start IP	This is the starting local IP address (ILA). Local IP addresses are <b>N/A</b> for <b>Server</b> port mapping.
Local End IP	<p>This is the end local IP address (ILA). If your rule is for all local IP addresses, then enter 0.0.0.0 as the <b>Local Start IP</b> address and 255.255.255.255 as the <b>Local End IP</b> address.</p> <p>This field is <b>N/A</b> for <b>One-to-One</b> and <b>Server</b> mapping types.</p>
Global Start IP	This is the starting global IP address (IGA). Enter 0.0.0.0 here if you have a dynamic IP address from your ISP.
Global End IP	This is the ending global IP address (IGA). This field is <b>N/A</b> for <b>One-to-One</b> , <b>Many-to-One</b> and <b>Server</b> mapping types.
Server Mapping Set	<p>Only available when <b>Type</b> is set to <b>Server</b>.</p> <p>Select a number from the drop-down menu to choose a server set from the <b>NAT - Address Mapping Rules</b> screen.</p>
Edit Details	Click this link to go to the <b>NAT - Edit SUA/NAT Server Set</b> screen to edit a server set that you have selected in the <b>Server Mapping Set</b> field.
Apply	Click <b>Apply</b> to save your changes back to the Prestige.
Cancel	Click <b>Cancel</b> to return to the previously saved settings.
Delete	Click <b>Delete</b> to exit this screen without saving



# Chapter 7

## Dynamic DNS Setup

*This chapter discusses how to configure your Prestige to use Dynamic DNS.*

### 7.1 Dynamic DNS

Dynamic DNS allows you to update your current dynamic IP address with one or many dynamic DNS services so that anyone can contact you (in NetMeeting, CU-SeeMe, etc.). You can also access your FTP server or Web site on your own computer using a domain name (for instance myhost.dhs.org, where myhost is a name of your choice) that will never change instead of using an IP address that changes each time you reconnect. Your friends or relatives will always be able to call you even if they don't know your IP address.

First of all, you need to have registered a dynamic DNS account with [www.dyndns.org](http://www.dyndns.org). This is for people with a dynamic IP from their ISP or DHCP server that would still like to have a domain name. The Dynamic DNS service provider will give you a password or key.

#### 7.1.1 DYNDNS Wildcard

Enabling the wildcard feature for your host causes \*.yourhost.dyndns.org to be aliased to the same IP address as yourhost.dyndns.org. This feature is useful if you want to be able to use, for example, [www.yourhost.dyndns.org](http://www.yourhost.dyndns.org) and still reach your hostname.

**If you have a private WAN IP address, then you cannot use Dynamic DNS.**

### 7.2 Configuring Dynamic DNS

To change your Prestige's DDNS, click **Dynamic DNS**. The screen appears as shown.

**Dynamic DNS**

Active

Service Provider: WWW.DynDNS.ORG

Host Name:

E-mail Address:

User:

Password:

Enable Wildcard

Apply Cancel

**Figure 7-1 DDNS**

The following table describes the labels in this screen.

**Table 7-1 DDNS**

LABEL	DESCRIPTION
Active	Select this check box to use dynamic DNS.
Service Provider	Select the name of your Dynamic DNS service provider.
Host Name	Type the domain name assigned to your Prestige by your Dynamic DNS provider.
E-mail Address	Type your e-mail address.
User	Type your user name.
Password	Type the password assigned to you.
Enable Wildcard	Select this check box to enable DYNDNS Wildcard.
Apply	Click <b>Apply</b> to save your changes back to the Prestige.
Cancel	Click <b>Cancel</b> to return to the previously saved settings.



# Chapter 8

## Time and Date Setup

*Use this screen to configure the Prestige's time and date settings.*

### 8.1 Configuring Time and Date

To change your Prestige's time and date, click **Time And Date**. The screen appears as shown. Use this screen to configure the Prestige's time based on your local time zone.

*Time and Date*

---

**Time Server**

Use Protocol when Bootup

IP Address or URL

Time and Date

Daylight Savings

Start Date  month  day

End Date  month  day

Synchronize system clock with Time Server now.  
(This may take up to 60 seconds.)

**Date**

Current Date  -  -

New Date (yyyy-mm-dd)  -  -

**Time**

Current Time  :  :

New Time  :  :

---

**Figure 8-1 Time and Date**

The following table describes the labels in this screen.

**Table 8-1 Time and Date**

LABEL	DESCRIPTION
Time Server	
Use Protocol when Bootup	<p>Select the time service protocol that your time server sends when you turn on the Prestige. Not all time servers support all protocols, so you may have to check with your ISP/network administrator or use trial and error to find a protocol that works.</p> <p>The main difference between them is the format.  <b>Daytime (RFC 867)</b> format is day/month/year/time zone of the server.  <b>Time (RFC 868)</b> format displays a 4-byte integer giving the total number of seconds since 1970/1/1 at 0:0:0.            The default, <b>NTP (RFC 1305)</b>, is similar to Time (RFC 868).            Select <b>None</b> to enter the time and date manually.</p>
IP Address or URL	<p>Enter the IP address or URL of your time server. Check with your ISP/network administrator if you are unsure of this information.</p>
Time and Date	<p>Choose the time zone of your location. This will set the time difference between your time zone and Greenwich Mean Time (GMT).</p>
Daylight Savings	<p>Select this option if you use daylight savings time. Daylight saving is a period from late spring to early fall when many countries set their clocks ahead of normal local time by one hour to give more daytime light in the evening.</p>
Start Date	<p>Enter the month and day that your daylight-savings time starts on if you selected <b>Daylight Savings</b>.</p>
End Date	<p>Enter the month and day that your daylight-savings time ends on if you selected <b>Daylight Savings</b>.</p>
Synchronize system clock with Time Server now.	<p>Click this button to have your Prestige use the time server (that you configured above) to set its internal system clock.</p> <p>Please wait for up to 60 seconds while the Prestige locates the time server. If the Prestige cannot find the time server, please check the time server protocol and its IP address. If the IP address was entered correctly, try pinging it for example to test the connection.</p>
Date	
Current Date	<p>This field displays the date of your Prestige. Each time you reload this page, the Prestige synchronizes the time with the time server.</p>

**Table 8-1 Time and Date**

<b>LABEL</b>	<b>DESCRIPTION</b>
New Date (yyyy-mm-dd)	This field displays the last updated date from the time server. When you select <b>None</b> in the <b>Use Protocol when Bootup</b> field, enter the new date in this field and then click <b>Apply</b> .
Time	
Current Time	This field displays the time of your Prestige. Each time you reload this page, the Prestige synchronizes the time with the time server.
New Time	This field displays the last updated time from the time server. When you select <b>None</b> in the <b>Use Protocol when Bootup</b> field, enter the new time in this field and then click <b>Apply</b> .
Apply	Click <b>Apply</b> to save your changes back to the Prestige.
Cancel	Click <b>Cancel</b> to return to the previously saved settings.

---

# Part IV:

---

## Remote Management and UPnP

---

This part contains information on how to configure the Prestige for remote management and setting up Universal Plug and Play (UPnP).

# Chapter 9

## Remote Management Configuration

*This chapter provides information on configuring remote management. Remote management is not available on all models*

### 9.1 Remote Management Overview

Remote management allows you to determine which services/protocols can access which Prestige interface (if any) from which computers.

You may manage your Prestige from a remote location via:

- Internet (WAN only)
- ALL (LAN and WAN)
- LAN only
- Neither (Disable)

To disable remote management of a service, select **Disable** in the corresponding **Server Access** field.

#### 9.1.1 Remote Management Limitations

Remote management over LAN or WAN will not work when:

1. A filter in SMT menu 3.1 (LAN) or in menu 11.5 (WAN) is applied to block a Telnet, FTP or Web service.
2. You have disabled that service in one of the remote management screens.
3. The IP address in the **Secured Client IP** field does not match the client IP address. If it does not match, the Prestige will disconnect the session immediately.
4. There is an SMT console session running.
5. There is already another remote management session of the same type (web, FTP or Telnet) running. You may only have one remote management session of the same type running at one time.
6. There is a web remote management session running with a Telnet session. A web session will be disconnected if you begin a Telnet session; it will not begin if there already is a Telnet session.

## 9.1.2 Remote Management and NAT

When NAT is enabled:

- Use the Prestige's WAN IP address when configuring from the WAN.
- Use the Prestige's LAN IP address when configuring from the LAN.

## 9.1.3 System Timeout

There is a system timeout of five minutes (three hundred seconds) for either the console port or telnet/web/FTP connections. Your Prestige automatically logs you out if you do nothing in this timeout period, except when it is continuously updating the status in menu 24.1 or when `sys studio` has been changed on the command line.

## 9.2 Telnet

You can configure your Prestige for remote Telnet access as shown next.

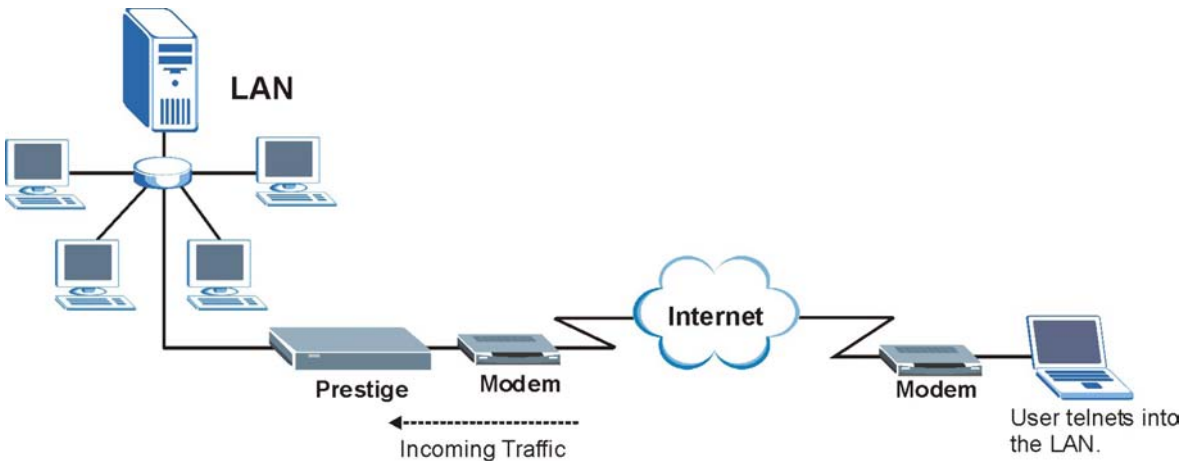

Figure 9-1 Telnet Configuration on a TCP/IP Network

## 9.3 FTP

You can upload and download Prestige firmware and configuration files using FTP. To use this feature, your computer must have an FTP client.

## 9.4 Web

You can use the Prestige's embedded web configurator for configuration and file management. See the online help for details.

## 9.5 Configuring Remote Management

Click **Remote Management** to open the following screen.

Server Type	Access Status	Port	Secured Client IP
Telnet	All	23	0.0.0.0
FTP	All	21	0.0.0.0
Web	All	80	0.0.0.0

**Figure 9-2 Remote Management**

The following table describes the labels in this screen.

**Table 9-1 Remote Management**

LABEL	DESCRIPTION
Server Type	Each of these labels denotes a service that you may use to remotely manage the Prestige.
Access Status	Select the access interface. Choices are <b>All</b> , <b>LAN Only</b> , <b>WAN Only</b> and <b>Disable</b> .
Port	This field shows the port number for the remote management service. You may change the port number for a service in this field, but you must use the same port number to use that service for remote management.

**Table 9-1 Remote Management**

<b>LABEL</b>	<b>DESCRIPTION</b>
Secured Client IP	The default 0.0.0.0 allows any client to use this service to remotely manage the Prestige. Type an IP address to restrict access to a client with a matching IP address.
Apply	Click <b>Apply</b> to save your settings back to the Prestige.
Cancel	Click <b>Cancel</b> to begin configuring this screen afresh.



# Chapter 10

## Universal Plug-and-Play (UPnP)

*This chapter introduces the UPnP feature in the web configurator.*

### 10.1 Universal Plug and Play Overview

Universal Plug and Play (UPnP) is a distributed, open networking standard that uses TCP/IP for simple peer-to-peer network connectivity between devices. A UPnP device can dynamically join a network, obtain an IP address, convey its capabilities and learn about other devices on the network. In turn, a device can leave a network smoothly and automatically when it is no longer in use.

#### 10.1.1 How do I know if I'm using UPnP?

UPnP hardware is identified as an icon in the Network Connections folder (Windows XP). Each UPnP compatible device installed on your network will appear as a separate icon. Selecting the icon of a UPnP device will allow you to access the information and properties of that device.

#### 10.1.2 NAT Traversal

UPnP NAT traversal automates the process of allowing an application to operate through NAT. UPnP network devices can automatically configure network addressing, announce their presence in the network to other UPnP devices and enable exchange of simple product and service descriptions. NAT traversal allows the following:

- Dynamic port mapping
- Learning public IP addresses
- Assigning lease times to mappings

Windows Messenger is an example of an application that supports NAT traversal and UPnP.

See the *Network Address Translation (NAT)* chapter for further information about NAT.

#### 10.1.3 Cautions with UPnP

The automated nature of NAT traversal applications in establishing their own services may present network security issues. Network information and configuration may also be obtained and modified by users in some network environments.

All UPnP-enabled devices may communicate freely with each other without additional configuration. Disable UPnP if this is not your intention.

## 10.2 UPnP and ZyXEL

ZyXEL has achieved UPnP certification from the Universal Plug and Play Forum Creates UPnP™ Implementers Corp. (UIC). ZyXEL's UPnP implementation supports IGD 1.0 (Internet Gateway Device). At the time of writing ZyXEL's UPnP implementation supports Windows Messenger 4.6 and 4.7 while Windows Messenger 5.0 and Xbox are still being tested.

UPnP broadcasts are only allowed on the LAN.

See later sections for examples of installing UPnP in Windows XP and Windows Me as well as an example of using UPnP in Windows.

### 10.2.1 Configuring UPnP

From the **Site Map** in the main menu, click **UPnP** under **Advanced Setup** to display the screen shown next.

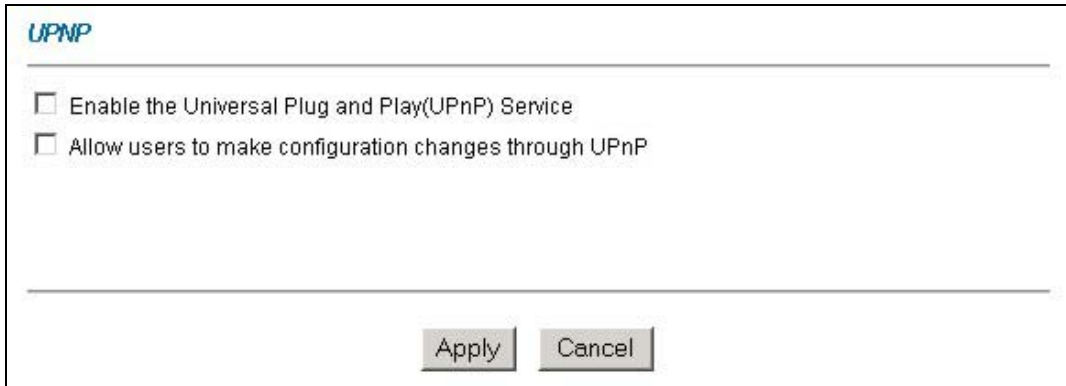

**Figure 10-1 Configuring UPnP**

The following table describes the labels in this screen.

**Table 10-1 Configuring UPnP**

LABEL	DESCRIPTION
Enable the Universal Plug and Play (UPnP) Service	Select this checkbox to activate UPnP. Be aware that anyone could use a UPnP application to open the web configurator's login screen without entering the Prestige's IP address (although you must still enter the password to access the web configurator).

**Table 10-1 Configuring UPnP**

LABEL	DESCRIPTION
Allow users to make configuration changes through UPnP	Select this check box to allow UPnP-enabled applications to automatically configure the Prestige so that they can communicate through the Prestige, for example by using NAT traversal. UPnP applications automatically reserve a NAT forwarding port in order to communicate with another UPnP enabled device; this eliminates the need to manually configure port forwarding for the UPnP enabled application.
Apply	Click <b>Apply</b> to save the setting to the Prestige.
Cancel	Click <b>Cancel</b> to return to the previously saved settings.

## 10.3 Installing UPnP in Windows Example

This section shows how to install UPnP in Windows Me and Windows XP.

### 10.3.1 Installing UPnP in Windows Me

Follow the steps below to install the UPnP in Windows Me.

- Step 1.** Click **Start** and **Control Panel**. Double-click **Add/Remove Programs**.
- Step 2.** Click on the **Windows Setup** tab and select **Communication** in the **Components** selection box. Click **Details**.

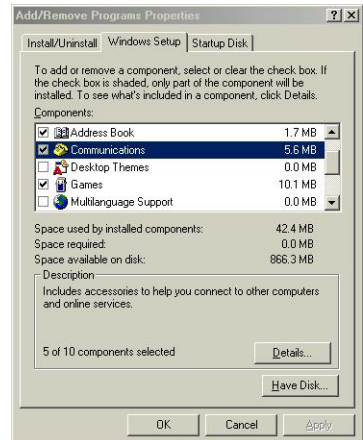

- Step 3.** In the **Communications** window, select the **Universal Plug and Play** check box in the **Components** selection box.
- Step 4.** Click **OK** to go back to the **Add/Remove Programs Properties** window and click **Next**.
- Step 5.** Restart the computer when prompted.

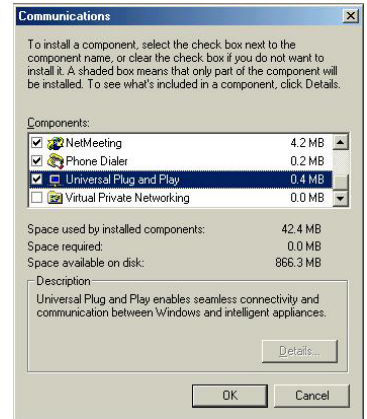

### 10.3.2 Installing UPnP in Windows XP

Follow the steps below to install the UPnP in Windows XP.

- Step 1.** Click **Start** and **Control Panel**.
- Step 2.** Double-click **Network Connections**.
- Step 3.** In the **Network Connections** window, click **Advanced** in the main menu and select **Optional Networking Components** ....  
The **Windows Optional Networking Components Wizard** window displays.
- Step 4.** Select **Networking Service** in the **Components** selection box and click **Details**.

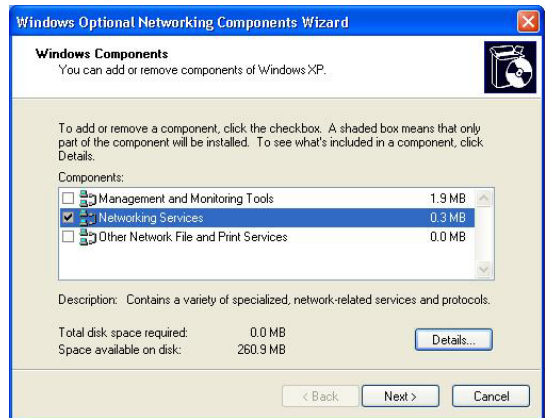
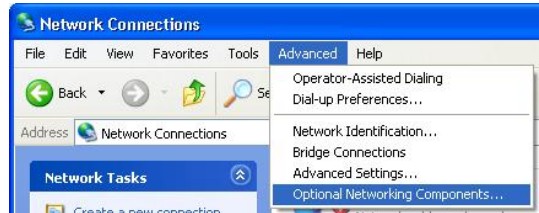

- Step 5.** In the **Networking Services** window, select the **Universal Plug and Play** check box.
- Step 6.** Click **OK** to go back to the **Windows Optional Networking Component Wizard** window and click **Next**.

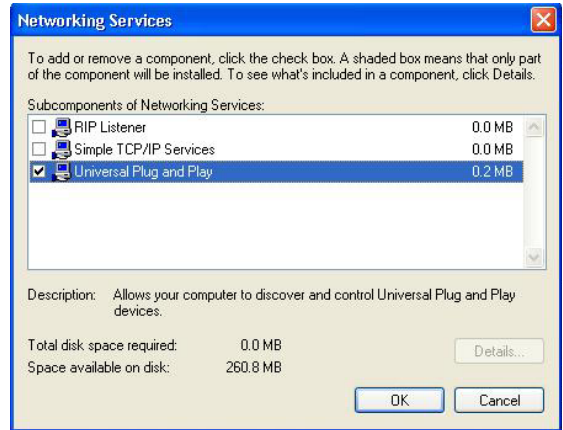

## 10.4 Using UPnP in Windows XP Example

This section shows you how to use the UPnP feature in Windows XP. You must already have UPnP installed in Windows XP and UPnP activated on the Prestige.

Make sure the computer is connected to a LAN port of the Prestige. Turn on your computer and the Prestige.

### 10.4.1 Auto-discover Your UPnP-enabled Network Device

- Step 1.** Click **start** and **Control Panel**. Double-click **Network Connections**. An icon displays under Internet Gateway.
- Step 2.** Right-click the icon and select **Properties**.



**Step 3.** In the **Internet Connection Properties** window, click **Settings** to see the port mappings there were automatically created.



**Step 4.** You may edit or delete the port mappings or click **Add** to manually add port mappings.

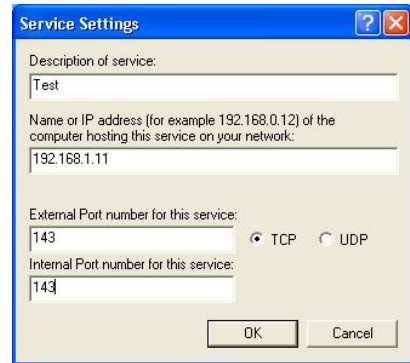
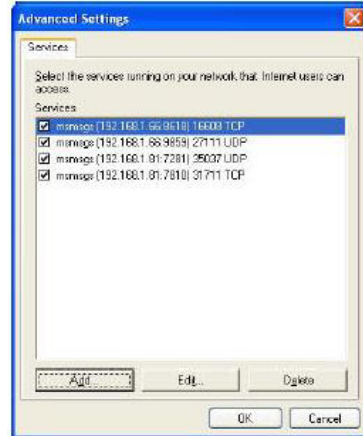

**When the UPnP-enabled device is disconnected from your computer, all port mappings will be deleted automatically.**

**Step 5.** Select **Show icon in notification area when connected** option and click **OK**. An icon displays in the system tray

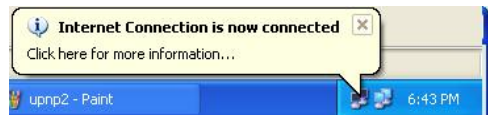

- Step 6.** Double-click on the icon to display your current Internet connection status.



## 10.4.2 Web Configurator Easy Access

With UPnP, you can access the web-based configurator on the Prestige without finding out the IP address of the Prestige first. This comes helpful if you do not know the IP address of the Prestige.

Follow the steps below to access the web configurator.

- Step 1.** Click **Start** and then **Control Panel**.
- Step 2.** Double-click **Network Connections**.
- Step 3.** Select **My Network Places** under **Other Places**.

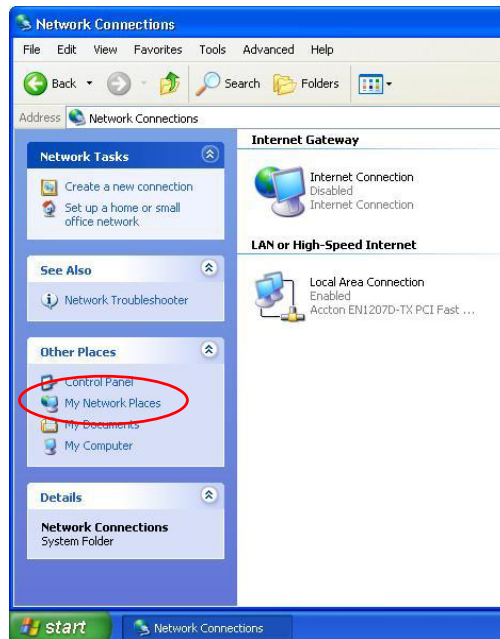

**Step 4.** An icon with the description for each UPnP-enabled device displays under **Local Network**.

**Step 5.** Right-click on the icon for your Prestige and select **Invoke**. The web configurator login screen displays.

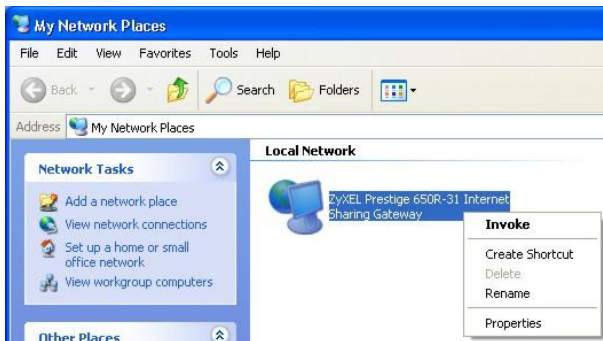

**Step 6.** Right-click on the icon for your Prestige and select **Properties**. A properties window displays with basic information about the Prestige.





---

# Part V:

---

## Maintenance

---

This part covers the maintenance screens.



# Chapter 11

## Maintenance

*This chapter displays system information such as ZyNOS firmware, port IP addresses and port traffic statistics.*

### 11.1 Maintenance Overview

Use the maintenance screens to view system information, upload new firmware, manage configuration and restart your Prestige.

### 11.2 System Status Screen

Click **System Status** to open the following screen, where you can use to monitor your Prestige. Note that these fields are READ-ONLY and are meant to be used for diagnostic purposes.

**System Status**

---

**System Status**

System Name : p623r-t1  
ZyNOS FW Version: V3.40(OO.1)b1 | 11/3/2003  
DSL FW Version: TrendChip, Version 0.2.15. ASIC 1.1 AnnexA  
Standard: Multi-Mode

**WAN Information**

IP Address: 0.0.0.0  
IP Subnet Mask: 0.0.0.0  
Default Gateway: 0.0.0.0  
VPI/VCI: 0/ 33

**LAN Information**

MAC Address: 00:a0:c5:5b:ce:2e  
IP Address: 192.168.1.1  
IP Subnet Mask: 255.255.255.0  
DHCP: Server  
DHCP Start IP: 192.168.1.33  
DHCP Pool Size: 32

[Show Statistics](#)

**Figure 11-1 System Status**

The following table describes the labels in this screen.

**Table 11-1 System Status**

LABEL	DESCRIPTION
System Status	
System Name	This is the name of your Prestige. It is for identification purposes.
ZyNOS F/W Version	This is the ZyNOS firmware version and the date created. ZyNOS is ZyXEL's proprietary Network Operating System design.
DSL FW Version	This is the DSL firmware version associated with your Prestige.
Standard	This is the standard that your Prestige is using.
WAN Information	
IP Address	This is the WAN port IP address.
IP Subnet Mask	This is the WAN port IP subnet mask.
Default Gateway	This is the IP address of the default gateway, if applicable.
VPI/VCI	This is the Virtual Path Identifier and Virtual Channel Identifier that you entered in the first Wizard screen.
LAN Information	
MAC Address	This is the MAC (Media Access Control) or Ethernet address unique to your Prestige.
IP Address	This is the LAN port IP address.
IP Subnet Mask	This is the LAN port IP subnet mask.
DHCP	This is the WAN port DHCP role - <b>Server, Relay</b> (not all Prestige models) or <b>None</b> .
DHCP Start IP	This is the first of the contiguous addresses in the IP address pool.
DHCP Pool Size	This is the number of IP addresses in the IP address pool.

**Table 11-1 System Status**

LABEL	DESCRIPTION
Show Statistics	Click <b>Show Statistics</b> to see router performance statistics such as number of packets sent and number of packets received for each port.

### 11.2.1 System Statistics

Click **Show Statistics** in the **System Status** screen to open the following screen. Read-only information here includes port status and packet specific statistics. Also provided are "system up time" and "poll interval(s)". The **Poll Interval(s)** field is configurable.

**System up Time: 0:06:02**  
CPU Load: **9.65%**

**WAN Port Statistics:**  
Link Status: **Down**  
Upstream Speed: **0 kbps**  
Downstream Speed: **0 kbps**

Node-Link	Status	TxPkts	RxPkts	Errors	Tx B/s	Rx B/s	Up Time
1-PPPoE	Idle	0	0	0	0	0	0:00:00

LAN Port Statistics:

Interface	Status	TxPkts	RxPkts	Collisions
Ethernet	Down	0	0	0
USB	UP	958	888	0

**Poll Interval(s) :**

**Figure 11-2 System Status: Show Statistics**

The following table describes the labels in this screen.

**Table 11-2 System Status: Show Statistics**

LABEL	DESCRIPTION
System up Time	This is the elapsed time the system has been up.
CPU Load	This field specifies the percentage of CPU utilization.
WAN Port Statistics	This is the WAN port.
Link Status	This is the status of your WAN link.
Upstream Speed	This is the upstream speed of your Prestige.
Downstream Speed	This is the downstream speed of your Prestige.
Node-Link	This field displays the remote node index number and link type. Link types are PPPoA, ENET, RFC 1483 and PPPoE.
Status	For the WAN port, this displays the port speed and duplex setting if you're using Ethernet encapsulation and <b>down</b> (line is down), <b>idle</b> (line (ppp) idle), <b>dial</b> (starting to trigger a call) and <b>drop</b> (dropping a call) if you're using PPPoE encapsulation. For a LAN port, this shows the port speed and duplex setting.
LAN Port Statistics	This is the LAN port.
Interface	This field displays the type of port.
TxPkts	This field displays the number of packets transmitted on this port.
RxPkts	This field displays the number of packets received on this port.
Errors	This field displays the number of error packets on this port.
Tx B/s	This field displays the number of bytes transmitted in the last second.
Rx B/s	This field displays the number of bytes received in the last second.
Up Time	This field displays the elapsed time this port has been up.
Collisions	This is the number of collisions on this port.
Poll Interval(s)	Type the time interval for the browser to refresh system statistics.

**Table 11-2 System Status: Show Statistics**

LABEL	DESCRIPTION
Set Interval	Click this button to apply the new poll interval you entered in the <b>Poll Interval</b> field above.
Stop	Click this button to halt the refreshing of the system statistics.

## 11.3 DHCP Table Screen

DHCP (Dynamic Host Configuration Protocol, RFC 2131 and RFC 2132) allows individual clients to obtain TCP/IP configuration at start-up from a server. You can configure the Prestige as a DHCP server or disable it. When configured as a server, the Prestige provides the TCP/IP configuration for the clients. If set to **None**, DHCP service will be disabled and you must have another DHCP server on your LAN, or else the computer must be manually configured.

Click **MAINTENANCE**, and then the **DHCP Table** tab. Read-only information here relates to your DHCP status. The DHCP table shows current DHCP client information (including **IP Address**, **Host Name** and **MAC Address**) of all network clients using the DHCP server.

*DHCP Table*

Host Name	IP Address	MAC Address
TWer-4	192.168.1.33	00-02-DD-32-91-6A
oemcomputer	192.168.1.35	00-A0-C5-41-A7-96

**Figure 11-3 DHCP Table**

The following table describes the labels in this screen.

**Table 11-3 DHCP Table**

LABEL	DESCRIPTION
Host Name	This is the name of the host computer.
IP Address	This field displays the IP address relative to the <b>Host Name</b> field.



**Table 11-3 DHCP Table**

LABEL	DESCRIPTION
MAC Address	<p>This field displays the MAC (Media Access Control) address of the computer with the displayed host name.</p> <p>Every Ethernet device has a unique MAC address. The MAC address is assigned at the factory and consists of six pairs of hexadecimal characters, for example, 00:A0:C5:00:00:02.</p>

## 11.4 Diagnostic Screens

These read-only screens display information to help you identify problems with the Prestige.

Click **Diagnostic** to display the following screen.

**Figure 11-4 Diagnostic**

### 11.4.1 Diagnostic General Screen

Click **Diagnostic** and then **General** to open the screen shown next.

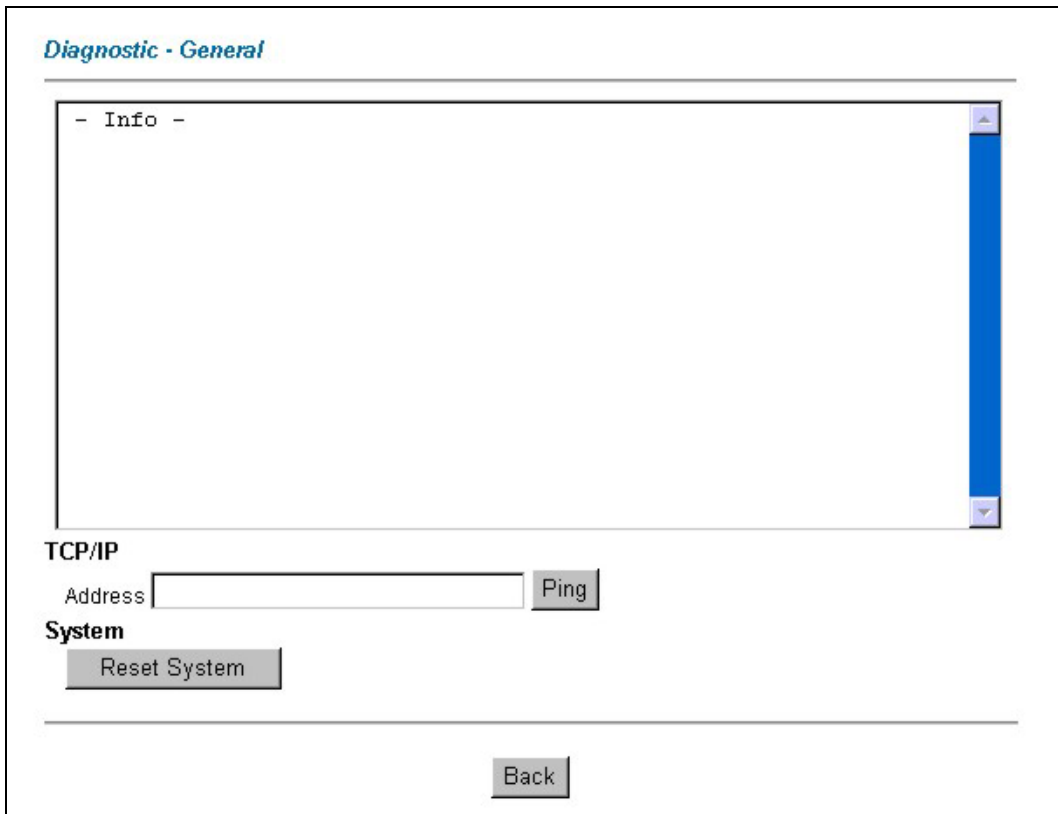

**Figure 11-5 Diagnostic General**

The following table describes the labels in this screen.

**Table 11-4 Diagnostic General**

LABEL	DESCRIPTION
TCP/IP Address	Type the IP address of a computer that you want to ping in order to test a connection.
Ping	Click this button to ping the IP address that you entered.
Reset System	Click this button to reboot the Prestige. A warning dialog box is then displayed asking you if you're sure you want to reboot the system. Click <b>OK</b> to proceed.

**Table 11-4 Diagnostic General**

LABEL	DESCRIPTION
Back	Click this button to go back to the main <b>Diagnostic</b> screen.

## 11.4.2 Diagnostic DSL Line Screen

Click **Diagnostic** and then **DSL Line** to open the screen shown next.

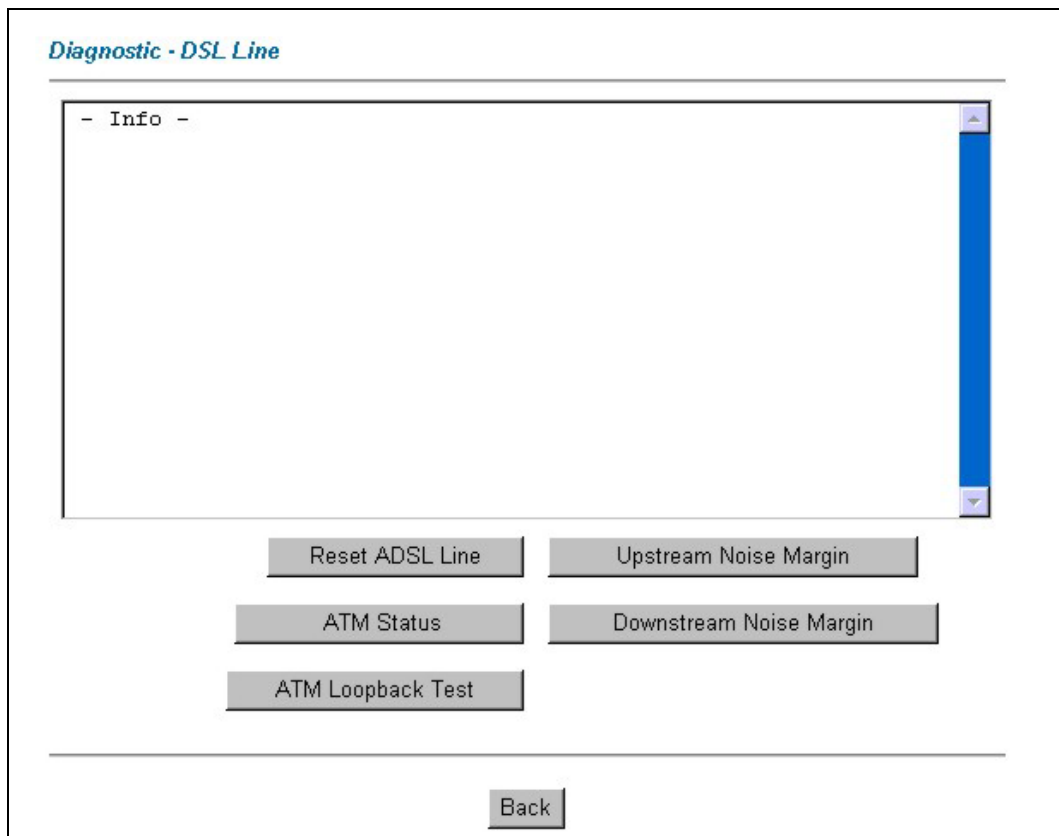
**Figure 11-6 Diagnostic DSL Line**

The following table describes the labels in this screen.

**Table 11-5 Diagnostic DSL Line**

LABEL	DESCRIPTION
Reset ADSL Line	Click this button to reinitialize the ADSL line. The large text box above then displays the progress and results of this operation, for example:  "Start to reset ADSL Loading ADSL modem F/W... Reset ADSL Line Successfully!"
ATM Status	Click this button to view ATM status.
ATM Loopback Test	Click this button to start the ATM loopback test. Make sure you have configured at least one PVC with proper VPIs/VCIs before you begin this test. The Prestige sends an OAM F5 packet to the DSLAM/ATM switch and then returns it (loops it back) to the Prestige. The ATM loopback test is useful for troubleshooting problems with the DSLAM and ATM network.
Upstream Noise Margin	Click this button to display the upstream noise margin.
Downstream Noise Margin	Click this button to display the downstream noise margin.
Back	Click this button to go back to the main <b>Diagnostic</b> screen.

## 11.5 Firmware Screen

Find firmware at [www.zyxel.com](http://www.zyxel.com) in a file that (usually) uses the system model name with a "\*.bin" extension, e.g., "Prestige.bin". The upload process uses HTTP (Hypertext Transfer Protocol) and may take up to two minutes. After a successful upload, the system will reboot. See the *Firmware and Configuration File Maintenance* chapter in the parts that document the SMT for upgrading firmware using FTP/TFTP commands.

**Only use firmware for your Prestige's specific model. Refer to the label on the bottom of your Prestige.**

Click **Firmware** to open the following screen. Follow the instructions in this screen to upload firmware to your Prestige.

**FIRMWARE**

---

**Firmware Upgrade**

To upgrade the internal router firmware, browse to the location of the binary (.BIN) upgrade file and click **UPLOAD**.

File Path:

**CONFIGURATION FILE**

---

**Click Reset to clear all user-defined configurations and return to the factory defaults.**

---

**Figure 11-7 Firmware Upgrade**

The following table describes the labels in this screen.

**Table 11-6 Firmware Upgrade**

LABEL	DESCRIPTION
File Path	Type in the location of the file you want to upload in this field or click <b>Browse ...</b> to find it.
Browse...	Click <b>Browse...</b> to find the .bin file you want to upload. Remember that you must decompress compressed (.zip) files before you can upload them.
Upload	Click <b>Upload</b> to begin the upload process. This process may take up to two minutes.
Reset	Click this button to clear all user-entered configuration information and return the Prestige to its factory defaults. Refer to the <i>Resetting the Prestige</i> section.

**Do not turn off the Prestige while firmware upload is in progress!**

After you see the **Firmware Upload in Process** screen, wait two minutes before logging into the Prestige again.

The Prestige automatically restarts in this time causing a temporary network disconnect. In some operating systems, you may see the following icon on your desktop.

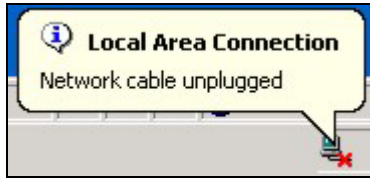

**Figure 11-8 Network Temporarily Disconnected**

After two minutes, log in again and check your new firmware version in the **System Status** screen.

If the upload was not successful, the following screen will appear. Click **Back** to go back to the **Firmware** screen.



**Figure 11-9 Error Message**

---

# Part VI:

---

---

## SMT General Configuration

---

This part covers System Management Terminal configuration for general setup, Ethernet setup, Internet access, remote nodes, remote node TCP/IP, static routing and NAT.

**See the web configurator parts of this guide for background information on features configurable by web configurator and SMT.**





# Chapter 12

## Introducing the SMT

*This chapter explains how to access and navigate the System Management Terminal and gives an overview of its menus.*

### 12.1 SMT Introduction

The Prestige's SMT (System Management Terminal) is a menu-driven interface that you can access from a terminal emulator through the console port or over a telnet connection.

#### 12.1.1 Procedure for SMT Configuration via Telnet

The following procedure details how to telnet into your Prestige.

- Step 1.** In Windows, click **Start** (usually in the bottom left corner), **Run** and then type "telnet 192.168.1.1" (the default IP address) and click **OK**.
- Step 2.** For your first login, enter the default password "1234". As you type the password, the screen displays an asterisk "\*" for each character you type.

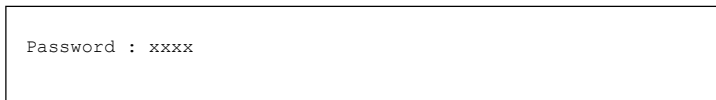

**Figure 12-1 Login Screen**

- Step 3.** After entering the password you will see the main menu.

Please note that if there is no activity for longer than five minutes (default timeout period) after you log in, your Prestige will automatically log you out. You will then have to telnet into the Prestige again.

#### 12.1.2 Prestige SMT Menu Overview

The following figure gives you an overview of the various SMT menu screens of your Prestige.

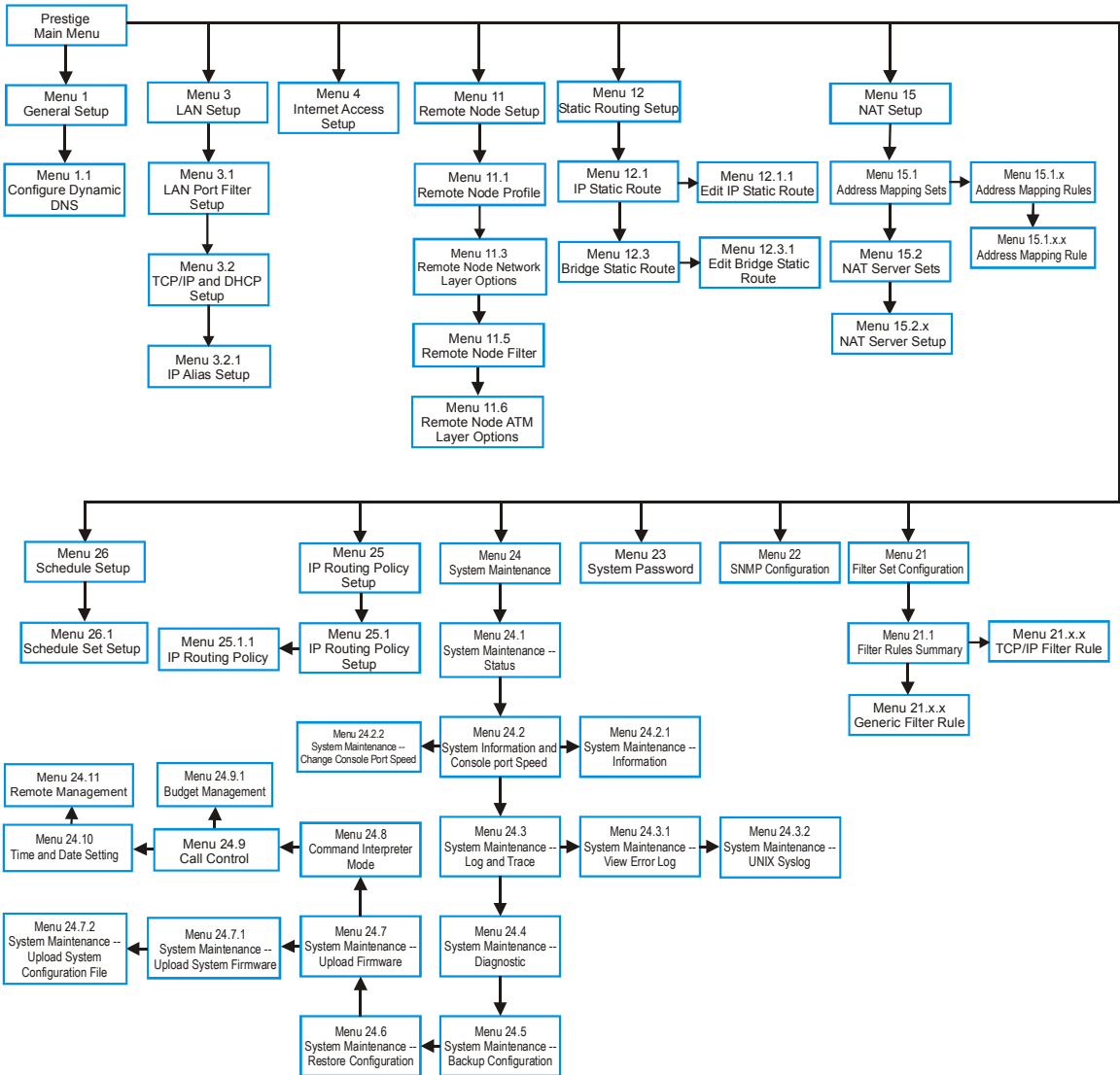

Figure 12-2 Prestige 623R-T SMT Menu Overview

## 12.2 Navigating the SMT Interface

The SMT (System Management Terminal) is the interface that you use to configure your Prestige.

Several operations that you should be familiar with before you attempt to modify the configuration are listed in the table below.

**Table 12-1 Main Menu Commands**

OPERATION	KEYSTROKE	DESCRIPTION
Move down to another menu	[ENTER]	To move forward to a submenu, type in the number of the desired submenu and press [ENTER].
Move up to a previous menu	[ESC]	Press [ESC] to move back to the previous menu.
Move to a "hidden" menu	Press [SPACE BAR] to change <b>No</b> to <b>Yes</b> then press [ENTER].	Fields beginning with "Edit" lead to hidden menus and have a default setting of <b>No</b> . Press [SPACE BAR] once to change <b>No</b> to <b>Yes</b> , then press [ENTER] to go to the "hidden" menu.
Move the cursor	[ENTER] or [UP]/[DOWN] arrow keys.	Within a menu, press [ENTER] to move to the next field. You can also use the [UP]/[DOWN] arrow keys to move to the previous and the next field, respectively.
Entering information	Type in or press [SPACE BAR], then press [ENTER].	You need to fill in two types of fields. The first requires you to type in the appropriate information. The second allows you to cycle through the available choices by pressing [SPACE BAR].
Required fields	<? > or <b>ChangeMe</b>	All fields with the symbol <? > must be filled in order to be able to save the new configuration.  All fields with <b>ChangeMe</b> must not be left blank in order to be able to save the new configuration.
N/A fields	<N/A>	Some of the fields in the SMT will show a <N/A>. This symbol refers to an option that is Not Applicable.
Save your configuration	[ENTER]	Save your configuration by pressing [ENTER] at the message "Press ENTER to confirm or ESC to cancel". Saving the data on the screen will take you, in most cases to the previous menu.
Exit the SMT	Type 99, then press [ENTER].	Type 99 at the main menu prompt and press [ENTER] to exit the SMT interface.

After you enter the password, the SMT displays the main menu, as shown next.

```

Copyright (c) 1994 - 2003 ZyXEL Communications Corp.

Prestige 623R-T1 Main Menu

Getting Started
1. General Setup
3. LAN Setup
4. Internet Access Setup

Advanced Applications
11. Remote Node Setup
12. Static Routing Setup
15. NAT Setup

Advanced Management
21. Filter Set Configuration
22. SNMP Configuration
23. System Password
24. System Maintenance
25. IP Routing Policy Setup
26. Schedule Setup

99. Exit

Enter Menu Selection Number:

```

**Figure 12-3 SMT Main Menu**

## 12.2.1 System Management Terminal Interface Summary

**Table 12-2 Main Menu Summary**

#	MENU TITLE	DESCRIPTION
1	General Setup	Use this menu to set up your general information.
3	LAN Setup	Use this menu to set up your LAN connection.
4	Internet Access Setup	A quick and easy way to set up an Internet connection.
11	Remote Node Setup	Use this menu to set up the Remote Node for LAN-to-LAN connection, including Internet connection.
12	Static Routing Setup	Use this menu to set up static routes.
15	NAT Setup	Use this menu to specify inside servers when NAT is enabled.
21	Filter Set Configuration	Use this menu to set up filters to provide security, etc.
22	SNMP Configuration	Use this menu to set up SNMP related parameters.
23	System Password	Use this menu to change your password.
24	System Maintenance	This menu provides system status, diagnostics, software upload, etc.
25	IP Routing Policy Setup	Use this menu to configure your IP routing policy.
26	Schedule Setup	Use this menu to schedule outgoing calls.
99	Exit	Use this to exit from SMT and return to a blank screen.

## 12.3 Changing the System Password

Change the Prestige default password by following the steps shown next.

- Step 1.** Enter 23 in the main menu to display **Menu 23 - System Security** as shown next.
- Step 2.** Type your existing system password in the **Old Password** field, for example “1234”, and press [ENTER].

```
Menu 23 - System Password

Old Password= ?
New Password= ?
Retype to confirm= ?

Enter here to CONFIRM or ESC to CANCEL:
```

**Figure 12-4 Menu 23 System Password**

- Step 3.** Type your new system password in the **New Password** field (up to 30 characters), and press [ENTER].
- Step 4.** Re-type your new system password in the **Retype to confirm** field for confirmation and press [ENTER].

Note that as you type a password, the screen displays an “\*” for each character you type.



# Chapter 13

## General Setup

*Menu 1 - General Setup contains administrative and system-related information.*

### 13.1 General Setup

**Menu 1 — General Setup** contains administrative and system-related information (shown next). The **System Name** field is for identification purposes. However, because some ISPs check this name you should enter your computer's "Computer Name".

- In Windows 95/98 click **Start, Settings, Control Panel, Network**. Click the **Identification** tab, note the entry for the **Computer name** field and enter it as the Prestige **System Name**.
- In Windows 2000 click **Start, Settings, Control Panel** and then double-click **System**. Click the **Network Identification** tab and then the **Properties** button. Note the entry for the **Computer name** field and enter it as the Prestige **System Name**.
- In Windows XP, click **Start, My Computer, View system information** and then click the **Computer Name** tab. Note the entry in the **Full computer name** field and enter it as the Prestige **System Name**.

The **Domain Name** entry is what is propagated to the DHCP clients on the LAN. If you leave this blank, the domain name obtained by DHCP from the ISP is used. While you must enter the host name (System Name) on each individual computer, the domain name can be assigned from the Prestige via DHCP.

### 13.2 Configuring Menu 1

Enter 1 in the Main Menu to open **Menu 1 — General Setup** (shown next).

```

Menu 1 - General Setup

System Name= p623r-t1
Location=
Contact Person's Name=
Domain Name=
Edit Dynamic DNS= No

Route IP= Yes
Bridge= No

Press ENTER to Confirm or ESC to Cancel:
    
```

**Figure 13-1 Menu 1 General Setup**

Fill in the required fields. Refer to the table shown next for more information about these fields.

**Table 13-1 Menu 1 General Setup**

FIELD	DESCRIPTION	EXAMPLE
System Name	Enter a descriptive name for identification purposes. This name can be up to 30 alphanumeric characters long. Spaces are not allowed, but dashes "-" and underscores "_" are accepted.	P623R-T1
Location (optional)	Enter the geographic location (up to 31 characters) of your Prestige.	MyHouse
Contact Person's Name (optional)	Enter the name (up to 30 characters) of the person in charge of this Prestige.	JohnDoe
Domain Name	Enter the domain name (if you know it) here. If you leave this field blank, the ISP may assign a domain name via DHCP. You can go to menu 24.8 and type "sys domainname" to see the current domain name used by your gateway.  If you want to clear this field just press the [SPACE BAR]. The domain name entered by you is given priority over the ISP assigned domain name.	zyxel.com.tw
Edit Dynamic DNS	Press the [SPACE BAR] to select <b>Yes</b> or <b>No</b> (default). Select <b>Yes</b> to configure <b>Menu 1.1 — Configure Dynamic DNS</b> (discussed next).	<b>No</b>
Route IP	Set this field to <b>Yes</b> to enable or <b>No</b> to disable IP routing. You must enable IP routing for Internet access.	<b>Yes</b>
Bridge	Turn on/off bridging for protocols not supported (for example, SNA) or not turned on in the previous <b>Route IP</b> field. Select <b>Yes</b> to turn bridging on; select <b>No</b> to turn bridging off.	<b>No</b>



**Table 13-1 Menu 1 General Setup**

FIELD	DESCRIPTION	EXAMPLE
When you have completed this menu, press [ENTER] at the prompt "Press ENTER to Confirm..." to save your configuration, or press [ESC] at any time to cancel.		

### 13.2.1 Configuring Dynamic DNS

**If you have a private WAN IP address, then you cannot use Dynamic DNS.**

To configure Dynamic DNS, go to **Menu 1 — General Setup** and select **Yes** in the **Edit Dynamic DNS** field. Press [ENTER] to display **Menu 1.1— Configure Dynamic DNS** as shown next.

```

Menu 1.1 - Configure Dynamic DNS

Service Provider= WWW.DynDNS.ORG
Active= No
Host=
EMAIL=
USER=
Password= *****
Enable Wildcard= No

Press ENTER to Confirm or ESC to Cancel:

```

**Figure 13-2 Menu 1.1 Configure Dynamic DNS**

Follow the instructions in the next table to configure Dynamic DNS parameters.

**Table 13-2 Menu 1.1 Configure Dynamic DNS**

FIELD	DESCRIPTION	EXAMPLE
Service Provider	This is the name of your Dynamic DNS service provider.	WWW.DynDNS.ORG (default)
Active	Press [SPACE BAR] to select <b>Yes</b> and then press [ENTER] to make dynamic DNS active.	<b>Yes</b>
Host	Enter the domain name assigned to your Prestige by your Dynamic DNS provider.	me.dyndns.org
EMAIL	Enter your e-mail address.	mail@mailserver
USER	Enter your user name.	

**Table 13-2 Menu 1.1 Configure Dynamic DNS**

<b>FIELD</b>	<b>DESCRIPTION</b>	<b>EXAMPLE</b>
Password	Enter the password assigned to you.	
Enable Wildcard	Your Prestige supports DYNDNS Wildcard. Press [SPACE BAR] and then [ENTER] to select <b>Yes</b> or <b>No</b> . This field is <b>N/A</b> when you choose DDNS client as your service provider.	<b>No</b>
When you have completed this menu, press [ENTER] at the prompt "Press ENTER to Confirm..." to save your configuration, or press [ESC] at any time to cancel.		

# Chapter 14

## LAN Setup

*This chapter covers how to configure your wired Local Area Network (LAN) settings.*

### 14.1 LAN Setup

This section describes how to configure the Ethernet using **Menu 3 — LAN Setup**. From the main menu, enter 3 to display menu 3.

```
Menu 3 - LAN Setup

1. LAN Port Filter Setup
2. TCP/IP and DHCP Setup

Enter Menu Selection Number:
```

**Figure 14-1 Menu 3 Ethernet Setup**

#### 14.1.1 LAN Port Filter Setup

This menu allows you to specify filter set(s) that you wish to apply to the Ethernet traffic. You seldom need to filter Ethernet traffic; however, the filter sets may be useful to block certain packets, reduce traffic and prevent security breaches.

```
Menu 3.1 - LAN Port Filter Setup

Input Filter Sets:
  protocol filters=
  device filters=
Output Filter Sets:
  protocol filters=
  device filters=

Press ENTER to Confirm or ESC to Cancel:
```

**Figure 14-2 Menu 3.1 LAN Port Filter Setup**

If you need to define filters, please read the *Filter Set Configuration* chapter first, then return to this menu to define the filter sets.

## 14.2 Protocol Dependent Ethernet Setup

Depending on the protocols for your applications, you need to configure the respective Ethernet Setup, as outlined below.

- For TCP/IP Ethernet setup refer to the *Internet Access Application* chapter.
- For bridging Ethernet setup refer to the *Bridging Setup* chapter.

## 14.3 TCP/IP Ethernet Setup and DHCP

Use menu 3.2 to configure your Prestige for TCP/IP.

To edit menu 3.2, enter 3 from the main menu to display **Menu 3 — Ethernet Setup**. When menu 3 appears, press 2 and press [ENTER] to display **Menu 3.2 — TCP/IP and DHCP Ethernet Setup**, as shown next:

The screenshot shows the configuration menu for Menu 3.2 - TCP/IP and DHCP Ethernet Setup. The fields are as follows:

```

Menu 3.2 - TCP/IP and DHCP Ethernet Setup

DHCP Setup:
  DHCP= Server
  Client IP Pool Starting Address= 192.168.1.33
  Size of Client IP Pool= 32
  Primary DNS Server= 0.0.0.0
  Secondary DNS Server= 0.0.0.0
  Remote DHCP Server= N/A

TCP/IP Setup:
  IP Address= 192.68.1.1
  IP Subnet Mask= 255.255.255.0
  RIP Direction= Both
    Version= RIP-1
  Multicast= None
  IP Policies=
  Edit IP Alias= No

Press ENTER to Confirm or ESC to Cancel:

Press Space Bar to Toggle.
    
```

Callouts on the right side of the image point to the following fields:

- First address in the IP pool (points to Client IP Pool Starting Address)
- Size of the IP Pool (points to Size of Client IP Pool)
- IP addresses of the DNS servers (points to Primary and Secondary DNS Server)
- This is the IP address of the Prestige (points to IP Address)

**Figure 14-3 Menu 3.2 TCP/IP and DHCP Ethernet Setup**

Follow the instructions in the following table on how to configure the DHCP fields.

**Table 14-1 DHCP Ethernet Setup Menu Fields**

FIELD	DESCRIPTION	EXAMPLE
DHCP Setup		

**Table 14-1 DHCP Ethernet Setup Menu Fields**

FIELD	DESCRIPTION	EXAMPLE
DHCP	<p>If set to <b>Server</b>, your Prestige can assign IP addresses, an IP default gateway and DNS servers to Windows 95, Windows NT and other systems that support the DHCP client.</p> <p>If set to <b>None</b>, the DHCP server will be disabled.</p> <p>If set to <b>Relay</b>, the Prestige acts as a surrogate DHCP server and relays DHCP requests and responses between the remote server and the clients. Enter the IP address of the actual, remote DHCP server in the Remote DHCP Server in this case.</p> <p>When DHCP is used, the following items need to be set:</p>	<b>Server</b> (default)
Client IP Pool Starting Address	This field specifies the first of the contiguous addresses in the IP address pool.	192.168.1.33
Size of Client IP Pool	This field specifies the size or count of the IP address pool.	32
Primary DNS Server Secondary DNS Server	Enter the IP addresses of the DNS servers. The DNS servers are passed to the DHCP clients along with the IP address and the subnet mask.	
Remote DHCP Server	If <b>Relay</b> is selected in the <b>DHCP</b> field above then enter the IP address of the actual remote DHCP server here.	

Follow the instructions in the following table to configure TCP/IP parameters for the Ethernet port.

**Table 14-2 TCP/IP Ethernet Setup Menu Fields**

FIELD	DESCRIPTION	EXAMPLE
TCP/IP Setup		
IP Address	Enter the (LAN) IP address of your Prestige in dotted decimal notation	192.168.1.1
IP Subnet Mask	Your Prestige will automatically calculate the subnet mask based on the IP address that you assign. Unless you are implementing subnetting, use the subnet mask computed by the Prestige.	255.255.255.0
RIP Direction	Press [SPACE BAR] to select the RIP direction. Choices are <b>Both</b> , <b>In Only</b> , <b>Out Only</b> or <b>None</b> .	<b>Both</b> (default)
Version	Press [SPACE BAR] to select the RIP version. Choices are <b>RIP-1</b> , <b>RIP-2B</b> or <b>RIP-2M</b> .	<b>RIP-1</b> (default)

**Table 14-2 TCP/IP Ethernet Setup Menu Fields**

<b>FIELD</b>	<b>DESCRIPTION</b>	<b>EXAMPLE</b>
Multicast	IGMP (Internet Group Multicast Protocol) is a network-layer protocol used to establish membership in a Multicast group. The Prestige supports both IGMP version 1 ( <b>IGMP-v1</b> ) and version 2 ( <b>IGMP-v2</b> ). Press the [SPACE BAR] to enable IP Multicasting or select <b>None</b> to disable it.	<b>None</b> (default)
IP Policies	Create policies using SMT menu 25 (see the <i>IP Policy Routing chapter</i> ) and apply them on the Prestige LAN interface here. You can apply up to four IP Policy sets (from twelve) by entering their numbers separated by commas.	2,4,7,9
Edit IP Alias	The Prestige supports three logical LAN interfaces via its single physical Ethernet interface with the Prestige itself as the gateway for each LAN network. Press [SPACE BAR] to change <b>No</b> to <b>Yes</b> and press [ENTER] to for menu 3.2.1	<b>No</b> (default)

# Chapter 15

## Internet Access

*This chapter shows you how to configure the LAN and WAN of your Prestige for Internet access.*

### 15.1 Internet Access Overview

Refer to the chapters on the web configurator's wizard, LAN and WAN screens for more background information on fields in the SMT screens covered in this chapter.

### 15.2 IP Policies

Traditionally, routing is based on the destination address *only* and the router takes the shortest path to forward a packet. IP Policy Routing (IPPR) provides a mechanism to override the default routing behavior and alter the packet forwarding based on the policy defined by the network administrator. Policy-based routing is applied to incoming packets on a per interface basis, prior to the normal routing. Create policies using SMT menu 25 (see *IP Policy Routing*) and apply them on the Prestige LAN and/or WAN interfaces using menus 3.2 (LAN) and 11.3 (WAN).

### 15.3 IP Alias

IP Alias allows you to partition a physical network into different logical networks over the same Ethernet interface. The Prestige supports three logical LAN interfaces via its single physical Ethernet interface with the Prestige itself as the gateway for each LAN network.

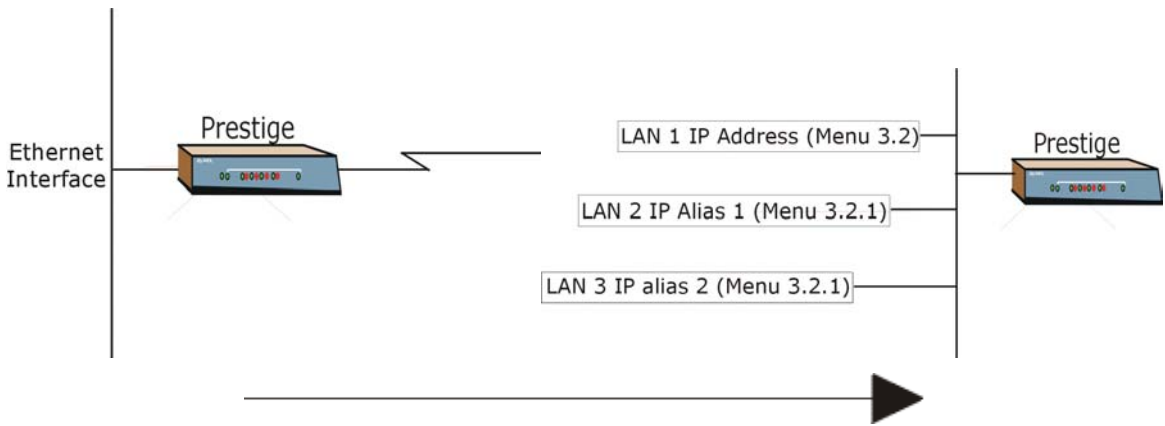

**Figure 15-1 Physical Network**

**Figure 15-2 Partitioned Logical Networks**

Use menu 3.2.1 to configure IP Alias on your Prestige.

## 15.4 IP Alias Setup

Use menu 3.2 to configure the first network. Move the cursor to **Edit IP Alias** field and press [SPACEBAR] to choose **Yes** and press [ENTER] to configure the second and third network.



```
Menu 3.2 - TCP/IP and DHCP Setup

DHCP Setup:
  DHCP= Server
  Client IP Pool Starting Address= 192.168.1.33
  Size of Client IP Pool= 32
  Primary DNS Server= 0.0.0.0
  Secondary DNS Server= 0.0.0.0
  Remote DHCP Server= N/A
TCP/IP Setup:
  IP Address= 192.168.1.1
  IP Subnet Mask= 255.255.255.0
  RIP Direction= None
  Version= N/A
  Multicast= None
  IP Policies=
  Edit IP Alias= Yes

Press ENTER to confirm or ESC to Cancel:

Press Space Bar to Toggle.
```

**Figure 15-3 Menu 3.2 TCP/IP and DHCP Setup**

Pressing [ENTER] displays **Menu 3.2.1 — IP Alias Setup**, as shown next.

```
Menu 3.2.1 - IP Alias Setup

IP Alias 1= Yes
  IP Address= 192.168.1.1
  IP Subnet Mask= 255.255.255.0
  RIP Direction= None
  Version= RIP-1
  Incoming protocol filters=
  Outgoing protocol filters=
IP Alias 2= No
  IP Address= N/A
  IP Subnet Mask= N/A
  RIP Direction= N/A
  Version= N/A
  Incoming protocol filters= N/A
  Outgoing protocol filters= N/A

Enter here to CONFIRM or ESC to CANCEL:
```

**Figure 15-4 Menu 3.2.1 IP Alias Setup**

Follow the instructions in the following table to configure IP Alias parameters.

**Table 15-1 Menu 3.2.1 IP Alias Setup**

FIELD	DESCRIPTION	EXAMPLE
IP Alias	Choose <b>Yes</b> to configure the LAN network for the Prestige.	<b>Yes</b>
IP Address	Enter the IP address of your Prestige in dotted decimal notation	192.168.1.1
IP Subnet Mask	Your Prestige will automatically calculate the subnet mask based on the IP address that you assign. Unless you are implementing subnetting, use the subnet mask computed by the Prestige	255.255.255.0
RIP Direction	Press [SPACE BAR] to select the RIP direction. Choices are <b>None</b> , <b>Both</b> , <b>In Only</b> or <b>Out Only</b> .	<b>None</b>
Version	Press [SPACE BAR] to select the RIP version. Choices are <b>RIP-1</b> , <b>RIP-2B</b> or <b>RIP-2M</b> .	<b>RIP-1</b>
Incoming Protocol Filters	Enter the filter set(s) you wish to apply to the incoming traffic between this node and the Prestige.	
Outgoing Protocol Filters	Enter the filter set(s) you wish to apply to the outgoing traffic between this node and the Prestige.	
When you have completed this menu, press [ENTER] at the prompt "Press ENTER to Confirm..." to save your configuration, or press [ESC] at any time to cancel.		

## 15.5 Route IP Setup

The first step is to enable the IP routing in **Menu 1 — General Setup**.

To edit menu 1, type in 1 in the main menu and press [ENTER]. Set the **Route IP** field to **Yes** by pressing [SPACE BAR].

```

Menu 1 - General Setup

System Name= P623R-T1
Location= location
Contact Person's Name=
Domain Name=
Edit Dynamic DNS= No

Route IP= Yes
Bridge= No

Press ENTER to Confirm or ESC to Cancel:

```

**Figure 15-5 Menu 1 General Setup**

## 15.6 Internet Access Configuration

Menu 4 allows you to enter the Internet Access information in one screen. Menu 4 is actually a simplified setup for one of the remote nodes that you can access in menu 11. Before you configure your Prestige for Internet access, you need to collect your Internet account information.

Use the *Internet Access Checklist* table in the *Read Me First* to record your Internet account information. Note that if you are using PPPoA or PPPoE encapsulation, then the only ISP information you need is a login name and password. You only need to know the Ethernet Encapsulation Gateway IP address if you are using ENET ENCAP encapsulation.

From the main menu, type 4 to display **Menu 4 - Internet Access Setup**, as shown next.

```

Menu 4 - Internet Access Setup

ISP's Name= MyISP
Encapsulation= ENET ENCAP
Multiplexing= LLC-based
VPI #= 1
VCI #= 32
ATM QoS Type= CBR
  Peak Cell Rate (PCR)= 0
  Sustain Cell Rate (SCR)= 0
  Maximum Burst Size (MBS)= 0
My Login= N/A
My Password= N/A
ENET ENCAP Gateway= 0.0.0.0
IP Address Assignment= Static
  IP Address= 0.0.0.0
Network Address Translation= SUA Only
  Address Mapping Set= N/A

Press ENTER to Confirm or ESC to Cancel:

```

**Figure 15-6 Menu 4 Internet Access Setup**

The following table contains instructions on how to configure your Prestige for Internet access.

**Table 15-2 Menu 4 Internet Access Setup**

FIELD	DESCRIPTION	EXAMPLE
ISP's Name	Enter the name of your Internet Service Provider. This information is for identification purposes only.	MyISP
Encapsulation	Press [SPACE BAR] to select the method of encapsulation used by your ISP. Choices are <b>PPPoE</b> , <b>PPPoA</b> , <b>RFC 1483</b> or <b>ENET ENCAP</b> .	ENET ENCAP

**Table 15-2 Menu 4 Internet Access Setup**

<b>FIELD</b>	<b>DESCRIPTION</b>	<b>EXAMPLE</b>
Multiplexing	Press [SPACE BAR] to select the method of multiplexing used by your ISP. Choices are <b>VC-based</b> or <b>LLC-based</b> .	LLC-based
VPI #	Enter the Virtual Path Identifier (VPI) assigned to you.	8
VCI #	Enter the Virtual Channel Identifier (VCI) assigned to you.	35
ATM QoS Type	Press [SPACE BAR] and select <b>CBR</b> (Continuous Bit Rate) to specify fixed (always-on) bandwidth. Select <b>UBR</b> (Unspecified Bit Rate) for applications that are non-time sensitive, such as e-mail. Select <b>VBR</b> (Variable Bit Rate) for bursty traffic and bandwidth sharing with other applications.	UBR
Peak Cell Rate (PCR)	This is the maximum rate at which the sender can send cells. Type the PCR.	0
Sustain Cell Rate (SCR)	Sustained Cell Rate is the mean cell rate of a bursty, on-off traffic source that can be sent at the peak rate, and a parameter for burst-type traffic. Type the SCR; it must be less than the PCR.	0
Maximum Burst Size (MBS)	Refers to the maximum number of cells that can be sent at the peak rate. Type the MBS. The MBS must be less than 65535.	0
My Login	Configure the <b>My Login</b> and <b>My Password</b> fields for PPPoA and PPPoE encapsulation only. Enter the login name that your ISP gives you. If you are using PPPoE encapsulation, then this field must be of the form <a href="#">user@domain</a> where domain identifies your PPPoE service name.	N/A
My Password	Enter the password associated with the login name above.	N/A
ENET ENCAP Gateway	Enter the gateway IP address supplied by your ISP when you are using <b>ENET ENCAP</b> encapsulation.	N/A
Idle Timeout	This value specifies the number of idle seconds that elapse before the Prestige automatically disconnects the PPPoE session.	0
IP Address Assignment	Press [SPACE BAR] to select <b>Static</b> or <b>Dynamic</b> address assignment.	Dynamic
IP Address	Enter the IP address supplied by your ISP if applicable.	N/A

**Table 15-2 Menu 4 Internet Access Setup**

FIELD	DESCRIPTION	EXAMPLE
Network Address Translation	Press [SPACE BAR] to select <b>None</b> , <b>SUA Only</b> or <b>Full Feature</b> . Please see the <i>NAT Chapter</i> for more details on the SUA (Single User Account) feature.	<b>SUA Only</b>
Address Mapping Set	When <b>Full Feature</b> is selected in the <b>NAT</b> field, configure address mapping sets in menu 15.1. Type the numbers of mapping sets (1-8) to use with NAT. See the <i>NAT</i> chapter for details.  When <b>SUA Only</b> is selected in the <b>NAT</b> field, the SMT uses NAT server set 1 in menu 15.1 (see the <i>NAT</i> chapter for details).	<b>N/A</b>
When you have completed this menu, press [ENTER] at the prompt "Press ENTER to confirm or ESC to cancel" to save your configuration or press [ESC] to cancel and go back to the previous screen.		

If all your settings are correct your Prestige should connect automatically to the Internet. If the connection fails, note the error message that you receive on the screen and take the appropriate troubleshooting steps.



# Chapter 16

## Remote Node Configuration

*This chapter covers remote node configuration.*

### 16.1 Remote Node Setup Overview

This section describes the protocol-independent parameters for a remote node. A remote node is required for placing calls to a remote gateway. A remote node represents both the remote gateway and the network behind it across a WAN connection. When you use menu 4 to set up Internet access, you are configuring one of the remote nodes.

You first choose a remote node in **Menu 11- Remote Node Setup**. You can then edit that node's profile in menu 11.1, as well as configure specific settings in three submenus: edit IP and bridge options in menu 11.3; edit ATM options in menu 11.6; and edit filter sets in menu 11.5.

### 16.2 Remote Node Setup

This section describes the protocol-independent parameters for a remote node.

#### 16.2.1 Remote Node Profile

To configure a remote node, follow these steps:

- Step 1.** From the main menu, enter 11 to display **Menu 11 - Remote Node Setup**.
- Step 2.** When menu 11 appears, as shown in the following figure, type the number of the remote node that you want to configure.

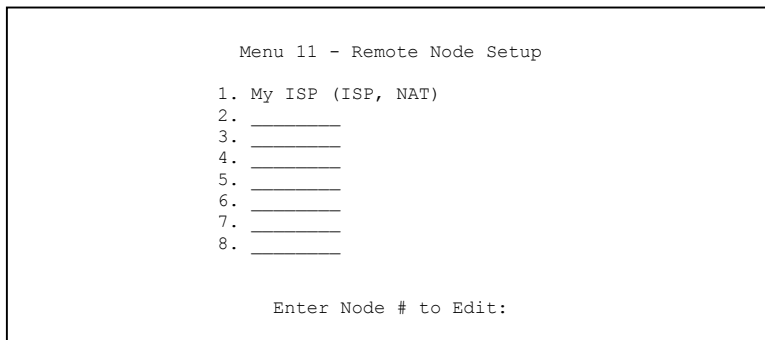

**Figure 16-1 Menu 11 Remote Node Setup**

## 16.2.2 Encapsulation and Multiplexing Scenarios

For Internet access you should use the encapsulation and multiplexing methods used by your ISP. Consult your ISP for information on encapsulation and multiplexing methods for LAN-to-LAN applications, for example between a branch office and corporate headquarters. There must be prior agreement on encapsulation and multiplexing methods because they cannot be automatically determined. What method(s) you use also depends on how many VCs you have and how many different network protocols you need. The extra overhead that ENET ENCAP encapsulation entails makes it a poor choice in a LAN-to-LAN application. Here are some examples of more suitable combinations in such an application.

Scenario 1. One VC, Multiple Protocols

**PPPoA** (RFC-2364) encapsulation with **VC-based** multiplexing is the best combination because no extra protocol identifying headers are needed. The **PPP** protocol already contains this information.

Scenario 2. One VC, One Protocol (IP)

Selecting **RFC-1483** encapsulation with **VC-based** multiplexing requires the least amount of overhead (0 octets). However, if there is a potential need for multiple protocol support in the future, it may be safer to select **PPPoA** encapsulation instead of **RFC-1483**, so you do not need to reconfigure either computer later.

Scenario 3. Multiple VCs

If you have an equal number (or more) of VCs than the number of protocols, then select **RFC-1483** encapsulation and **VC-based** multiplexing.



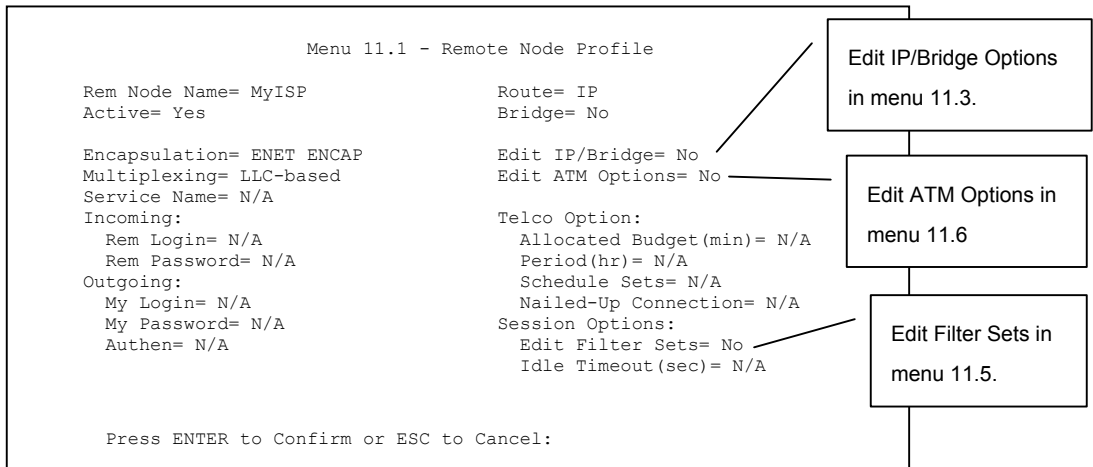

**Figure 16-2 Menu 11.1 Remote Node Profile**

In **Menu 11.1 – Remote Node Profile**, fill in the fields as described in the following table.

**Table 16-1 Menu 11.1 Remote Node Profile**

FIELD	DESCRIPTION	EXAMPLE
Rem Node Name	Type a unique, descriptive name of up to eight characters for this node.	MyISP
Active	Press [SPACE BAR] and then [ENTER] to select <b>Yes</b> to activate or <b>No</b> to deactivate this node. Inactive nodes are displayed with a minus sign “-“ in SMT menu 11.	<b>Yes</b>
Encapsulation	<b>PPPoA</b> refers to RFC-2364 (PPP Encapsulation over ATM Adaptation Layer 5). If RFC-1483 (Multiprotocol Encapsulation over ATM Adaptation Layer 5) of <b>ENET ENCAP</b> are selected, then the <b>Rem Login</b> , <b>Rem Password</b> , <b>My Login</b> , <b>My Password</b> and <b>Authen</b> fields are not applicable ( <b>N/A</b> ).	<b>ENET ENCAP</b>
Multiplexing	Press [SPACE BAR] and then [ENTER] to select the method of multiplexing that your ISP uses, either <b>VC-based</b> or <b>LLC-based</b> .	<b>LLC-based</b>
Service Name	When using <b>PPPoE</b> encapsulation, type the name of your PPPoE service here.	N/A
Incoming:		

**Table 16-1 Menu 11.1 Remote Node Profile**

<b>FIELD</b>	<b>DESCRIPTION</b>	<b>EXAMPLE</b>
Rem Login	Type the login name that this remote node will use to call your Prestige. The login name and the <b>Rem Password</b> will be used to authenticate this node.	
Rem Password	Type the password used when this remote node calls your Prestige.	
Outgoing:		
My Login	Type the login name assigned by your ISP when the Prestige calls this remote node.	
My Password	Type the password assigned by your ISP when the Prestige calls this remote node.	
Authen	This field sets the authentication protocol used for outgoing calls. Options for this field are:  <b>CHAP/PAP</b> – Your Prestige will accept either <b>CHAP</b> or <b>PAP</b> when requested by this remote node.  <b>CHAP</b> – accept <b>CHAP</b> (Challenge Handshake Authentication Protocol) only.  <b>PAP</b> – accept <b>PAP</b> (Password Authentication Protocol) only.	
Route	This field determines the protocol used in routing. Options are <b>IP</b> and <b>None</b> .	<b>IP</b>
Bridge	When bridging is enabled, your Prestige will forward any packet that it does not route to this remote node; otherwise, the packets are discarded. Select <b>Yes</b> to enable and <b>No</b> to disable.	<b>No</b>
Edit IP/Bridge	Press [SPACE BAR] to select <b>Yes</b> and press [ENTER] to display <b>Menu 11.3 – Remote Node Network Layer Options</b> .	<b>No</b>
Edit ATM Options	Press [SPACE BAR] to select <b>Yes</b> and press [ENTER] to display <b>Menu 11.6 – Remote Node ATM Layer Options</b> .	<b>No</b>
Telco Option		
Allocated Budget (min)	This sets a ceiling for outgoing call time for this remote node. The default for this field is 0 meaning no budget control.	
Period (hr)	This field is the time period that the budget should be reset. For example, if we are allowed to call this remote node for a maximum of 10 minutes every hour, then the <b>Allocated Budget</b> is (10 minutes) and the <b>Period (hr)</b> is 1 (hour).	

**Table 16-1 Menu 11.1 Remote Node Profile**

FIELD	DESCRIPTION	EXAMPLE
Schedule Sets	This field is only applicable for <b>PPPoE</b> and <b>PPPoA</b> encapsulation. You can apply up to four schedule sets here. For more details please refer to the <i>Call Scheduling</i> chapter.	
Nailed up Connection	This field is only applicable for <b>PPPoE</b> and <b>PPPoA</b> encapsulation. This field specifies if you want to make the connection to this remote node a nailed-up connection.	
Session Options		
Edit Filter Sets	Use [SPACE BAR] to choose <b>Yes</b> and press [ENTER] to open menu 11.5 to edit the filter sets. See the <i>Remote Node Filter</i> section for more details.	<b>No</b> (default)
Idle Timeout (sec)	Type the number of seconds (0-9999) that can elapse when the Prestige is idle (there is no traffic going to the remote node), before the Prestige automatically disconnects the remote node. 0 means that the session will not timeout.	
When you have completed this menu, press [ENTER] at the prompt "Press ENTER to confirm or ESC to cancel" to save your configuration or press [ESC] to cancel and go back to the previous screen.		

### 16.2.3 Outgoing Authentication Protocol

For obvious reasons, you should employ the strongest authentication protocol possible. However, some vendors' implementation includes specific authentication protocol in the user profile. It will disconnect if the negotiated protocol is different from that in the user profile, even when the negotiated protocol is stronger than specified. If the peer disconnects right after a successful authentication, make sure that you specify the correct authentication protocol when connecting to such an implementation.

## 16.3 Metric

The metric represents the "cost of transmission". A router determines the best route for transmission by choosing a path with the lowest "cost". RIP routing uses hop count as the measurement of cost, with a minimum of "1" for directly connected networks. The number must be between "1" and "15"; a number greater than "15" means the link is down. The smaller the number, the lower the "cost".

The metric sets the priority for the Prestige's routes to the Internet. If any two of the default routes have the same metric, the Prestige uses the following pre-defined priorities:

1. Normal route: designated by the ISP
2. Traffic-redirect route

**IP Policy Routing overrides the default routing behavior and takes priority over all of the routes mentioned above (see the *IP Policy Routing* chapter).**

For example, if the normal route has a metric of "1" and the traffic-redirect route has a metric of "2", then the normal route acts as the primary default route. If the normal route fails to connect to the Internet, the Prestige tries the traffic-redirect route next.

## 16.4 Remote Node Network Layer Options

For the TCP/IP parameters, perform the following steps to edit **Menu 11.3 – Remote Node Network Layer Options** as shown next.

- Step 1.** In menu 11.1, make sure **IP** is among the protocols in the **Route** field.
- Step 2.** Move the cursor to the **Edit IP/Bridge** field, press [SPACE BAR] to select **Yes**, then press [ENTER] to display **Menu 11.3 – Remote Node Network Layer Options**.

```

Menu 11.3 - Remote Node Network Layer Options

IP Options:                               Bridge Options:
IP Address Assignment= Dynamic           Ethernet Addr Timeout (min)= N/A
Rem IP Addr= 0.0.0.0
Rem Subnet Mask= 0.0.0.0
My WAN Addr= 0.0.0.0
NAT= Full Feature
    Address Mapping Set= 2
Metric= 2
Private= No
RIP Direction= None
    Version= RIP-1
Multicast= None
IP Policies= 3,4,5,6

Press ENTER to Confirm or ESC to Cancel:
    
```

**Figure 16-3 Menu 11.3 Remote Node Network Layer Options**

The next table explains fields in **Menu 11.3 – Remote Node Network Layer Options**.

**Table 16-2 Menu 11.3 Remote Node Network Layer Options**

FIELD	DESCRIPTION	EXAMPLE
IP Address Assignment	Press [SPACE BAR] and then [ENTER] to select <b>Dynamic</b> if the remote node is using a dynamically assigned IP address or <b>Static</b> if it is using a static (fixed) IP address. You will only be able to configure this in the ISP node (also the one you configure in menu 4). All other nodes are set to <b>Static</b> .	<b>Dynamic</b>
Rem IP Addr	This is the IP address you entered in the previous menu.	
Rem Subnet Mask	Type the subnet mask assigned to the remote node.	
My WAN Addr	Some implementations, especially UNIX derivatives, require separate IP network numbers for the WAN and LAN links and each end to have a unique address within the WAN network number. In that case, type the IP address assigned to the WAN port of your Prestige.  <div style="border: 1px solid black; background-color: #e0e0e0; padding: 5px; text-align: center; margin: 10px auto; width: fit-content;"> <b>Refers to local Prestige address, not the remote router address.</b> </div>	

**Table 16-2 Menu 11.3 Remote Node Network Layer Options**

<b>FIELD</b>	<b>DESCRIPTION</b>	<b>EXAMPLE</b>
NAT	<p>Press [SPACE BAR] and then [ENTER] to select <b>Full Feature</b> if you have multiple public WAN IP addresses for your Prestige.</p> <p>Select <b>SUA Only</b> if you have just one public WAN IP address for your Prestige. The SMT uses Address Mapping Set 255 (menu 15.1 - see section 19.3.1).</p> <p>Select <b>None</b> to disable NAT.</p>	<b>SUA Only</b>
Address Mapping Set	<p>When <b>Full Feature</b> is selected in the <b>NAT</b> field, configure address mapping sets in menu 15.1. Select one of the NAT server sets (2-10) in menu 15.2 (see the <i>NAT</i> chapter for details) and type that number here.</p> <p>When <b>SUA Only</b> is selected in the <b>NAT</b> field, the SMT uses NAT server set 1 in menu 15.2 (see the <i>NAT</i> chapter for details).</p>	2
Metric	The metric represents the “cost” of transmission for routing purposes. IP routing uses hop count as the cost measurement, with a minimum of 1 for directly connected networks. Type a number that approximates the cost for this link. The number need not be precise, but it must be between 1 and 15. In practice, 2 or 3 is usually a good number.	2
Private	This determines if the Prestige will include the route to this remote node in its RIP broadcasts. If set to <b>Yes</b> , this route is kept private and not included in RIP broadcast. If <b>No</b> , the route to this remote node will be propagated to other hosts through RIP broadcasts.	<b>No</b>
RIP Direction	Press [SPACE BAR] and then [ENTER] to select the RIP Direction. Options are <b>Both</b> , <b>In Only</b> , <b>Out Only</b> or <b>None</b> .	<b>None</b>
Version	Press [SPACE BAR] and then [ENTER] to select the RIP version. Options are <b>RIP-1</b> , <b>RIP-2B</b> or <b>RIP-2M</b> .	<b>RIP-1</b>
Multicast	<b>IGMP-v1</b> sets IGMP to version 1, <b>IGMP-v2</b> sets IGMP to version 2 and <b>None</b> disables IGMP.	<b>None</b>
IP Policies	You can apply up to four IP Policy sets (from 12) by typing in their numbers separated by commas. Configure the filter sets in menu 25 first (see the <i>IP Policy Routing</i> chapter) and then apply them here.	3, 4, 5, 6
When you have completed this menu, press [ENTER] at the prompt “Press ENTER to confirm or ESC to cancel” to save your configuration or press [ESC] to cancel and go back to the previous screen.		

## 16.4.1 My WAN Addr Sample IP Addresses

The following figure uses sample IP addresses to help you understand the field of **My Wan Addr** in menu 11.3. Refer to the previous *LAN and WAN IP Addresses* figure in the web configurator chapter on LAN setup for a brief review of what a WAN IP is. **My WAN Addr** indicates the local Prestige WAN IP (172.16.0.1 in the following figure) while **Rem IP Addr** indicates the peer WAN IP (172.16.0.2 in the following figure).

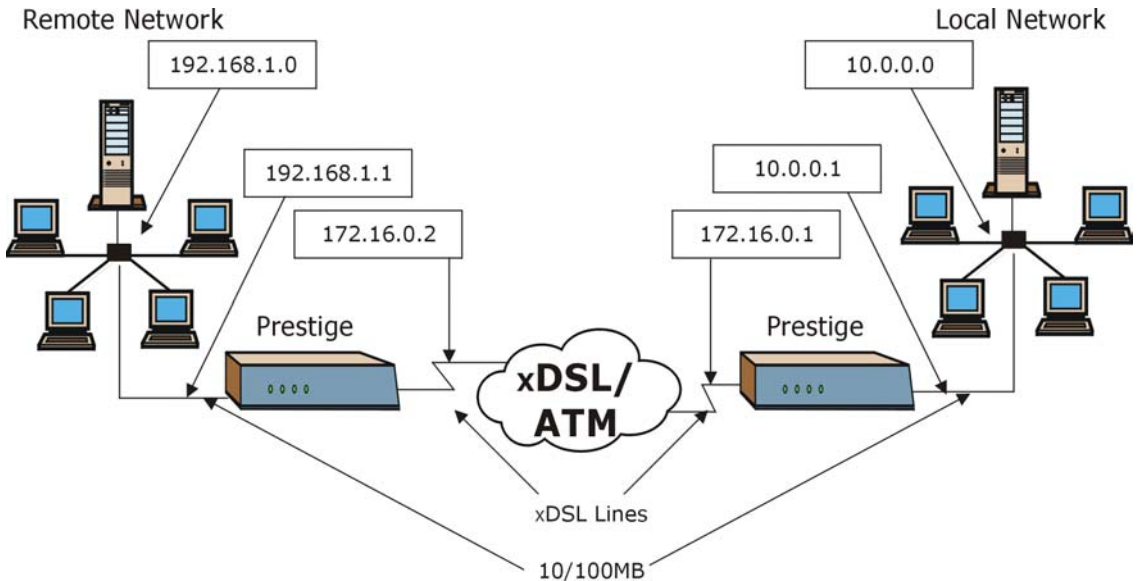

Figure 16-4 Sample IP Addresses for a TCP/IP LAN-to-LAN Connection

## 16.5 Remote Node Filter

Move the cursor to the **Edit Filter Sets** field in menu 11.1, then press [SPACE BAR] to select **Yes**. Press [ENTER] to display **Menu 11.5 – Remote Node Filter**.

Use **Menu 11.5 – Remote Node Filter** to specify the filter set(s) to apply to the incoming and outgoing traffic between this remote node and the Prestige and also to prevent certain packets from triggering calls. You can specify up to 4 filter sets separated by comma, for example, 1, 5, 9, 12, in each filter field.

Note that spaces are accepted in this field. The Prestige has a prepackaged filter set, NetBIOS\_WAN, that blocks NetBIOS packets (call protocol filter = 1). Include this in the call filter sets if you want to prevent NetBIOS packets from triggering calls to a remote node.

```
Menu 11.5 - Remote Node Filter

Input Filter Sets:
  protocol filters= 11, 12
  device filters=
Output Filter Sets:
  protocol filters=
  device filters=

Enter here to CONFIRM or ESC to CANCEL:
```

**Figure 16-5 Menu 11.5 Remote Node Filter (RFC 1483 or ENET Encapsulation)**

```
Menu 11.5 - Remote Node Filter

Input Filter Sets:
  protocol filters= 11, 12
  device filters=
Output Filter Sets:
  protocol filters=
  device filters=
Call Filter Sets:
  Protocol filters=
  Device filters=

Enter here to CONFIRM or ESC to CANCEL:
```

**Figure 16-6 Menu 11.5 Remote Node Filter (PPPoA or PPPoE Encapsulation)**

### 16.5.1 Web Configurator Internet Security Filter Rules

In the web configurator, open the **Security** screen as shown next. Select the predefined filter rules and click **Apply**.



**Internet Security**

Your device provides the following filter rules

<input type="checkbox"/> Telnet	Telnet traffic is blocked from the WAN to the LAN
<input type="checkbox"/> FTP	FTP traffic is blocked from the WAN to the LAN
<input type="checkbox"/> TFTP	TFTP traffic is blocked from the WAN to the LAN
<input type="checkbox"/> Web	Web traffic is blocked from the WAN to the LAN
<input type="checkbox"/> SNMP	SNMP traffic is blocked from the WAN
<input type="checkbox"/> Ping	Ping traffic is blocked from the WAN

**Figure 16-7 Internet Security**

Once you apply the filter rules in the web configurator, filter sets 11 and 12 are automatically applied in the **protocol filters** field under **Input Filter Sets** in SMT menu 11.5.

**SMT input protocol filter set numbers that were previously applied are erased after you apply the Internet Security filter rules in the web configurator. To reapply them or apply new filter sets, you need to enter the filter set numbers again along with filter sets 11 and 12. For example, to apply filter sets 1 and 2, you enter “1, 2, 11, 12”.**

## 16.5.2 Web Configurator Filter Sets

When you apply filter rules using the web configurator, filter sets 11 and 12 are automatically generated in SMT menu 21.

```

Menu 21 - Filter Set Configuration

Filter          Filter
Set #          Set #
-----          -----
1      NetBIOS_WAN      7      _____
2      NetBIOS_LAN     8      _____
3      TELNET_WAN      9      _____
4      PPPoE           10     _____
5      FTP_WAN         11     WebSet1
6      _____     12     WebSet2

Enter Filter Set Number to Configure= 0
Edit Comments= N/A
Press ENTER to Confirm or ESC to Cancel:
    
```

**Figure 16-8 Menu 21- Filer Set Configuration**

The following figures display the filter rules in filter sets 11 and 12.

```

Menu 21.11 - Filter Rules Summary

# A Type          Filter Rules          M m n
-----          -----          - - -
1 Y IP   Pr=17, SA=0.0.0.0, DA=0.0.0.0, DP=161      N D N
2 Y IP   Pr=17, SA=0.0.0.0, DA=0.0.0.0, DP=162      N D F
3 N
4 N
5 N
6 N

Enter Filter Rule Number (1-6) to Configure:
    
```

**Figure 16-9 Menu 21.11- WebSet 11**

```

Menu 21.12 - Filter Rules Summary

# A Type          Filter Rules          M m n
-----          -----          - - -
1 Y IP   Pr=6, SA=0.0.0.0, DA=0.0.0.0, DP=23      N D N
2 Y IP   Pr=6, SA=0.0.0.0, DA=0.0.0.0, DP=21      N D N
3 Y IP   Pr=17, SA=0.0.0.0, DA=0.0.0.0, DP=69      N D N
4 Y IP   Pr=6, SA=0.0.0.0, DA=0.0.0.0, DP=80      N D N
5 Y IP   Pr=1, SA=0.0.0.0, DA=0.0.0.0, DP=0        N D N
6 N

Enter Filter Rule Number (1-6) to Configure
    
```

**Figure 16-10 Menu 21.12- WebSet 12**

**Do not edit filter sets 11 and 12. They are used exclusively by the web configurator. Any rules you configured in sets 11 and 12 will be erased and replaced when you apply the web configurator-generated filter rules.**

## 16.6 Editing ATM Layer Options

Follow the steps shown next to edit **Menu 11.6 – Remote Node ATM Layer Options**.

In menu 11.1, move the cursor to the **Edit ATM Options** field and then press [SPACE BAR] to select **Yes**. Press [ENTER] to display **Menu 11.6 – Remote Node ATM Layer Options**.

There are two versions of menu 11.6 for the Prestige, depending on whether you chose **VC-based/LLC-based** multiplexing and **PPP** encapsulation in menu 11.1.

### 16.6.1 VC-based Multiplexing (non-PPP Encapsulation)

For **VC-based** multiplexing, by prior agreement, a protocol is assigned a specific virtual circuit, for example, VC1 will carry IP. Separate VPI and VCI numbers must be specified for each protocol.

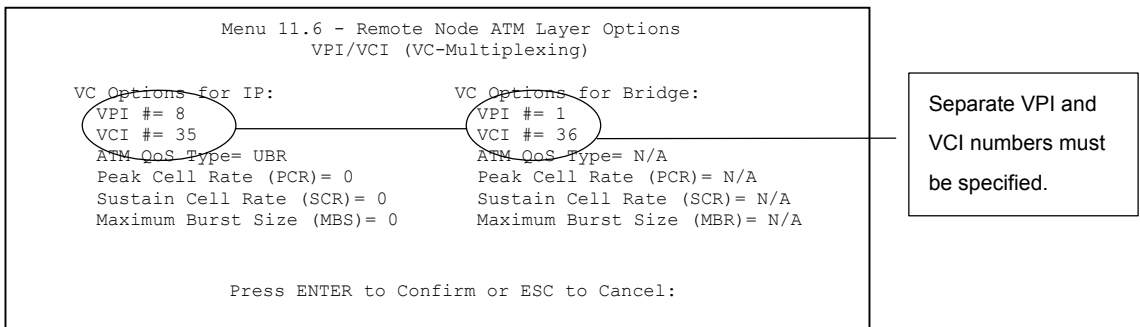

**Figure 16-11 Menu 11.6 for VC-based Multiplexing**

### 16.6.2 LLC-based Multiplexing or PPP Encapsulation

For **LLC-based** multiplexing or **PPP** encapsulation, one VC carries multiple protocols with protocol identifying information being contained in each packet header.

```
Menu 11.6 - Remote Node ATM Layer Options
VPI/VCI (LLC-Multiplexing or PPP-Encapsulation)

VPI # = 8
VCI # = 35
ATM QoS Type = UBR
Peak Cell Rate (PCR) = 0
Sustain Cell Rate (SCR) = 0
Maximum Burst Size (MBS) = 0

ENTER here to CONFIRM or ESC to CANCEL:
.
```

Only one set of VPI and VCI numbers needs to be specified.

**Figure 16-12 Menu 11.6 for LLC-based Multiplexing or PPP Encapsulation**

In this case, only one set of VPI and VCI numbers need be specified for all protocols. The valid range for the VPI is 0 to 255 and for the VCI is 32 to 65535 (1 to 31 is reserved for local management of ATM traffic).

# Chapter 17

## Static Route Setup

*This chapter shows how to setup IP static routes.*

### 17.1 IP Static Route Overview

Static routes tell the Prestige routing information that it cannot learn automatically through other means. This can arise in cases where RIP is disabled on the LAN or a remote network is beyond the one that is directly connected to a remote node.

Each remote node specifies only the network to which the gateway is directly connected and the Prestige has no knowledge of the networks beyond. For instance, the Prestige knows about network N2 in the following figure through remote node Router 1. However, the Prestige is unable to route a packet to network N3 because it does not know that there is a route through remote node Router 1 (via Router 2). The static routes allow you to tell the Prestige about the networks beyond the remote nodes.

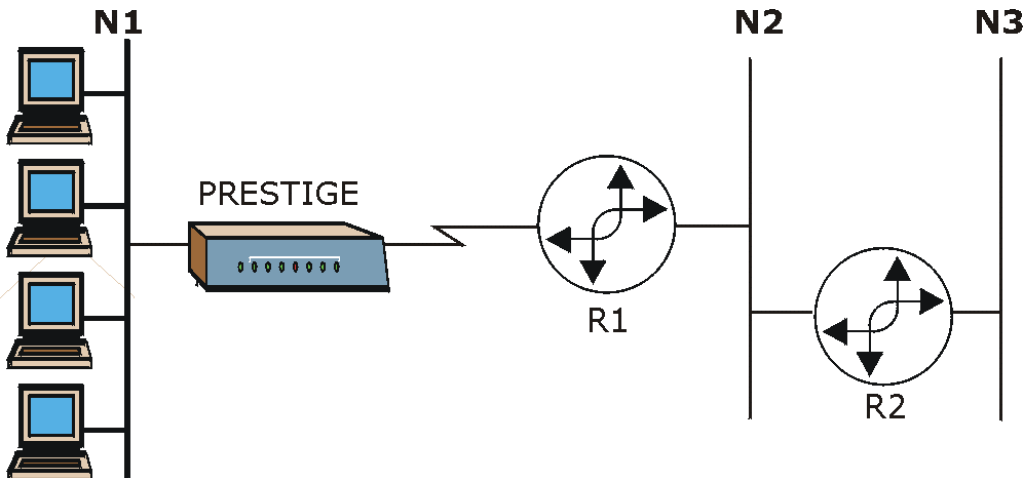

**Figure 17-1 Sample Static Routing Topology**

## 17.2 Configuring an IP static route

**Step 1.** To configure an IP static route, use **Menu 12 – Static Route Setup** (shown next).

```
Menu 12 - Static Route Setup

    1. IP Static Route
    3. Bridge Static Route

Please enter selection:
```

**Figure 17-2 Menu 12 Static Route Setup**

**Step 2.** From menu 12, select 1 to open **Menu 12.1 — IP Static Route Setup** (shown next).

```
Menu 12.1 - IP Static Route Setup

1. _____
2. _____
3. _____
4. _____
5. _____
6. _____
7. _____
8. _____
9. _____
10. _____
11. _____
12. _____
13. _____
14. _____
15. _____
16. _____

Enter selection number:
```

**Figure 17-3 Menu 12.1 IP Static Route Setup**

**Step 3.** Now, type the route number of a static route you want to configure.

```

Menu 12.1.1 - Edit IP Static Route

Route #: 1
Route Name= ?
Active= No
Destination IP Address= ?
IP Subnet Mask= ?
Gateway IP Address= ?
Metric= 2
Private= No

Press ENTER to Confirm or ESC to Cancel:

```

**Figure 17-4 Menu12.1.1 Edit IP Static Route**

The following table describes the fields for **Menu 12.1.1 – Edit IP Static Route Setup**.

**Table 17-1 Menu12.1.1 Edit IP Static Route**

FIELD	DESCRIPTION
Route #	This is the index number of the static route that you chose in menu 12.1.
Route Name	Type a descriptive name for this route. This is for identification purpose only.
Active	This field allows you to activate/deactivate this static route.
Destination IP Address	This parameter specifies the IP network address of the final destination. Routing is always based on network number. If you need to specify a route to a single host, use a subnet mask of 255.255.255.255 in the subnet mask field to force the network number to be identical to the host ID.
IP Subnet Mask	Type the subnet mask for this destination. Follow the discussion on <i>IP Subnet Mask</i> in this manual.
Gateway IP Address	Type the IP address of the gateway. The gateway is an immediate neighbor of your Prestige that will forward the packet to the destination. On the LAN, the gateway must be a router on the same segment as your Prestige; over WAN, the gateway must be the IP address of one of the remote nodes.
Metric	Metric represents the “cost” of transmission for routing purposes. IP routing uses hop count as the measurement of cost, with a minimum of 1 for directly connected networks. Type a number that approximates the cost for this link. The number need not be precise, but it must be between 1 and 15. In practice, 2 or 3 is usually a good number.

**Table 17-1 Menu12.1.1 Edit IP Static Route**

FIELD	DESCRIPTION
Private	This parameter determines if the Prestige will include the route to this remote node in its RIP broadcasts. If set to <b>Yes</b> , this route is kept private and is not included in RIP broadcasts. If <b>No</b> , the route to this remote node will be propagated to other hosts through RIP broadcasts.
When you have completed this menu, press [ENTER] at the prompt "Press ENTER to confirm or ESC to cancel" to save your configuration or press [ESC] to cancel and go back to the previous screen.	



# Chapter 18

## Bridging Setup

*This chapter shows you how to configure the bridging parameters of your Prestige.*

### 18.1 Bridging Overview

Bridging bases the forwarding decision on the MAC (Media Access Control), or hardware address, while routing does it on the network layer (IP) address. Bridging allows the Prestige to transport packets of network layer protocols that it does not route, for example, SNA, from one network to another. The caveat is that, compared to routing, bridging generates more traffic for the same network layer protocol, and it also demands more CPU cycles and memory.

For efficiency reasons, do *not* turn on bridging unless you need to support protocols other than IP on your network. For IP, enable the routing if you need it; do not bridge what the Prestige can route.

### 18.2 Bridge Ethernet Setup

Basically, all non-local packets are bridged to the WAN. Your Prestige does not support IPX.

#### 18.2.1 Remote Node Bridging Setup

Follow the procedure in another section to configure the protocol-independent parameters in **Menu 11.1 – Remote Node Profile**. For bridging-related parameters, you need to configure **Menu 11.3 – Remote Node Network Layer Options**.

To setup **Menu 11.3 – Remote Node Network Layer Options** shown in the next figure, follow these steps:

**Step 1.** In menu 11.1, make sure the **Bridge** field is set to **Yes**.

```
Menu 11.1 - Remote Node Profile

Rem Node Name= ?           Route= IP
Active= Yes                Bridge= Yes

Encapsulation= ENET ENCAP Edit IP/Bridge= Yes
Multiplexing= VC-based    Edit ATM Options= No
Service Name= N/A

Incoming:                  Telco Option:
  Rem Login= N/A          Allocated Budget(min)= N/A
  Rem Password= N/A      Period(hr)= N/A
                          Schedule Sets= N/A
                          Nailed-Up Connection= N/A
Outgoing:                  Session Options:
  My Login= N/A          Edit Filter Sets= No
  My Password= N/A      Idle Timeout(sec)= N/A
  Authen= N/A

Press ENTER to Confirm or ESC to Cancel:
```

**Figure 18-1 Menu 11.1 Remote Node Profile**

- Step 2.** Move the cursor to the **Edit IP/Bridge** field, then press [SPACE BAR] to set the value to **Yes** and press [ENTER] to edit **Menu 11.3 – Remote Node Network Layer Options**.

```
Menu 11.3 - Remote Node Network Layer Options

IP Options:                Bridge Options:
IP Address Assignment= Static Ethernet Addr Timeout (min)= 0
Rem IP Addr: 0.0.0.0
  Rem Subnet Mask= 0.0.0.0
  My WAN Addr= 0.0.0.0
  NAT= Full Feature
    Address Mapping Set=2
  Metric= 2
  Private= No
  RIP Direction= Both
    Version= RIP-2B
  Multicast= IGMP-v2
  IP Policies=

Press ENTER to Confirm or ESC to Cancel:
```

**Figure 18-2 Menu 11.3 Remote Node Network Layer Options**

**Table 18-1 Menu 11.3 Remote Node Network Layer Options : Bridge Fields**

FIELD	DESCRIPTION
Bridge (menu 11.1)	Make sure this field is set to <b>Yes</b> .
Edit IP/Bridge (menu 11.1)	Press [SPACE BAR] to select <b>Yes</b> and press [ENTER] to display menu 11.3.
Ethernet Addr Timeout (min.) (menu 11.3)	Type the time (in minutes) for the Prestige to retain the Ethernet Address information in its internal tables while the line is down. If this information is retained, your Prestige will not have to recompile the tables when the line comes back up.
When you have completed this menu, press [ENTER] at the prompt "Press ENTER to confirm or ESC to cancel" to save your configuration or press [ESC] to cancel and go back to the previous screen.	

## 18.2.2 Bridge Static Route Setup

Similar to network layer static routes, a bridging static route tells the Prestige the route to a node before a connection is established. You configure bridge static routes in menu 12.3.1 (go to menu 12, choose option 3, then choose a static route to edit) as shown next.

```

Menu 12.3.1 - Edit Bridge Static Route

Route #: 1
Route Name=
Active= No
Ether Address= ?
IP Address=
Gateway Node= 1

Press ENTER to Confirm or ESC to Cancel:

```

**Figure 18-3 Menu 12.3.1 Edit Bridge Static Route**

The following table describes the **Edit Bridge Static Route** menu.

**Table 18-2 Menu 12.3.1 Edit Bridge Static Route**

FIELD	DESCRIPTION
Route #	This is the route index number you typed in <b>Menu 12.3 – Bridge Static Route Setup</b> .
Route Name	Type a name for the bridge static route for identification purposes.

**Table 18-2 Menu 12.3.1 Edit Bridge Static Route**

<b>FIELD</b>	<b>DESCRIPTION</b>
Active	Indicates whether the static route is active ( <b>Yes</b> ) or not ( <b>No</b> ).
Ether Address	Type the MAC address of the destination computer that you want to bridge the packets to.
IP Address	If available, type the IP address of the destination computer that you want to bridge the packets to.
Gateway Node	Press [SPACE BAR] and then [ENTER] to select the number of the remote node (one to eight) that is the gateway of this static route.
When you have completed this menu, press [ENTER] at the prompt "Press ENTER to confirm or ESC to cancel" to save your configuration or press [ESC] to cancel and go back to the previous screen.	

# Chapter 19

## Network Address Translation (NAT)

*This chapter discusses how to configure NAT on the Prestige.*

### 19.1 NAT Overview

#### 19.1.1 SUA (Single User Account) Versus NAT

SUA (Single User Account) is a ZyNOS implementation of a subset of NAT that supports two types of mapping, **Many-to-One** and **Server**. See *section 19.3.1* for a detailed description of the NAT set for SUA. The Prestige also supports **Full Feature** NAT to map multiple global IP addresses to multiple private LAN IP addresses of clients or servers using mapping types as outlined in the web configurator part of this guide.

1. **Choose SUA Only if you have just one public WAN IP address for your Prestige.**
2. **Choose Full Feature if you have multiple public WAN IP addresses for your Prestige.**

### 19.2 Applying NAT

You apply NAT via menus 4 or 11.3 as displayed next. The next figure shows you how to apply NAT for Internet access in menu 4. Enter 4 from the main menu to go to **Menu 4 - Internet Access Setup**.

```
Menu 4 - Internet Access Setup

ISP's Name= MyISP
Encapsulation= PPPoE
Multiplexing= LLC-based
VPI #= 1
VCI #= 32
ATM QoS Type= CBR
  Peak Cell Rate (PCR)= 0
  Sustain Cell Rate (SCR)= 0
  Maximum Burst Size (MBS)= 0
My Login= 1234
My Password= *****
Idle Timeout (sec)= 0
IP Address Assignment= Dynamic
  IP Address= N/A
Network Address Translation= SUA Only
  Address Mapping Set= N/A

Press ENTER to Confirm or ESC to Cancel:Press Space Bar to Toggle.
```

**Figure 19-1 Menu 4 Applying NAT for Internet Access**

The following figure shows how you apply NAT to the remote node in menu 11.1.

- Step 1.** Enter 11 from the main menu.
- Step 2.** When menu 11 appears, as shown in the following figure, type the number of the remote node that you want to configure.
- Step 3.** Move the cursor to the **Edit IP/Bridge** field, press [SPACE BAR] to select **Yes** and then press [ENTER] to bring up **Menu 11.3 - Remote Node Network Layer Options**.

```

Menu 11.3 - Remote Node Network Layer Options

IP Options:                               Bridge Options:
IP Address Assignment = Dynamic           Ethernet Addr Timeout(min)= N/A
Rem IP Addr = 0.0.0.0
Rem Subnet Mask= 0.0.0.0
My WAN Addr= N/A
NAT= SUA Only
  Address Mapping Set= N/A
Metric= 2
Private= No
RIP Direction= None
  Version= RIP-1
Multicast= None
IP Policies=

Enter here to CONFIRM or ESC to CANCEL:
    
```

**Figure 19-2 Menu 11.3 Applying NAT to the Remote Node**

The following table describes the options for Network Address Translation.

**Table 19-1 Applying NAT in Menus 4 & 11.3**

FIELD	DESCRIPTION	EXAMPLE
NAT	Press [SPACE BAR] and then [ENTER] to select <b>Full Feature</b> if you have multiple public WAN IP addresses for your Prestige. The SMT uses the address mapping set that you configure and enter in the <b>Address Mapping Set</b> field (menu 15.1 - see section 19.3.1).	<b>Full Feature</b>
	Select <b>None</b> to disable NAT.	<b>None</b>
	When you select <b>SUA Only</b> , the SMT uses Address Mapping Set 255 (menu 15.1 - see section 19.3.1). Choose <b>SUA Only</b> if you have just one public WAN IP address for your Prestige.	<b>SUA Only</b>

### 19.3 NAT Setup

Use the address mapping sets menus and submenus to create the mapping table used to assign global addresses to computers on the LAN. **Set 255** is used for SUA. When you select **Full Feature** in menu 4 or 11.3, the SMT will use **Set 1**. When you select **SUA Only**, the SMT will use the pre-configured **Set 255** (read only).

The server set is a list of LAN servers mapped to external ports. To use this set, a server rule must be set up inside the NAT address mapping set. Please see the section on port forwarding in the chapter on NAT web configurator screens for further information on these menus. To configure NAT, enter 15 from the main menu to bring up the following screen.

```
Menu 15 - NAT Setup

1.  Address Mapping Sets
2.  NAT Server Sets

Enter Menu Selection Number:
```

**Figure 19-3 Menu 15 NAT Setup**

### 19.3.1 Address Mapping Sets

Enter 1 to bring up **Menu 15.1 — Address Mapping Sets**.

```
Menu 15.1 - Address Mapping Sets

1.  ACL Default Set
2.
3.
4.
5.
6.
7.
8.
255. SUA (read only)

Enter Menu Selection Number:
Enter Menu Selection Number:
```

**Figure 19-4 Menu 15.1 Address Mapping Sets**

#### SUA Address Mapping Set

Enter 255 to display the next screen (see also *section 19.1.1*). The fields in this menu cannot be changed.



```

Menu 15.1.255 - Address Mapping Rules

Set Name= SUA

Idx  Local Start IP  Local End IP  Global Start IP  Global End IP  Type
-----
1.   0.0.0.0         255.255.255.255  0.0.0.0         0.0.0.0         M-1
2.                                     0.0.0.0         Server+
3.
4.
5.
6.
7.
8.
9.
10.

Press ENTER to Confirm or ESC to Cancel:

```

**Figure 19-5 Menu 15.1.255 SUA Address Mapping Rules**

The following table explains the fields in this menu.

**Menu 15.1.255 is read-only.**

**Table 19-2 SUA Address Mapping Rules**

FIELD	DESCRIPTION	EXAMPLE
Set Name	This is the name of the set you selected in menu 15.1 or enter the name of a new set you want to create.	SUA
Idx	This is the index or rule number.	1
Local Start IP	<b>Local Start IP</b> is the starting local IP address (ILA).	0.0.0.0
Local End IP	<b>Local End IP</b> is the ending local IP address (ILA). If the rule is for all local IPs, then the Start IP is 0.0.0.0 and the End IP is 255.255.255.255.	255.255.255.255
Global Start IP	This is the starting global IP address (IGA). If you have a dynamic IP, enter 0.0.0.0 as the <b>Global Start IP</b> .	0.0.0.0
Global End IP	This is the ending global IP address (IGA).	
Type	These are the mapping types. <b>Server</b> allows us to specify multiple servers of different types behind NAT to this machine. See later for some examples.	Server

**Table 19-2 SUA Address Mapping Rules**

FIELD	DESCRIPTION	EXAMPLE
When you have completed this menu, press [ENTER] at the prompt "Press ENTER to confirm or ESC to cancel" to save your configuration or press [ESC] to cancel and go back to the previous screen.		

**User-Defined Address Mapping Sets**

Now let's look at option 1 in menu 15.1. Enter 2 to bring up this menu. We'll just look at the differences from the previous menu. Note the extra **Action** and **Select Rule** fields mean you can configure rules in this screen. Note also that the [?] in the **Set Name** field means that this is a required field and you must enter a name for the set.

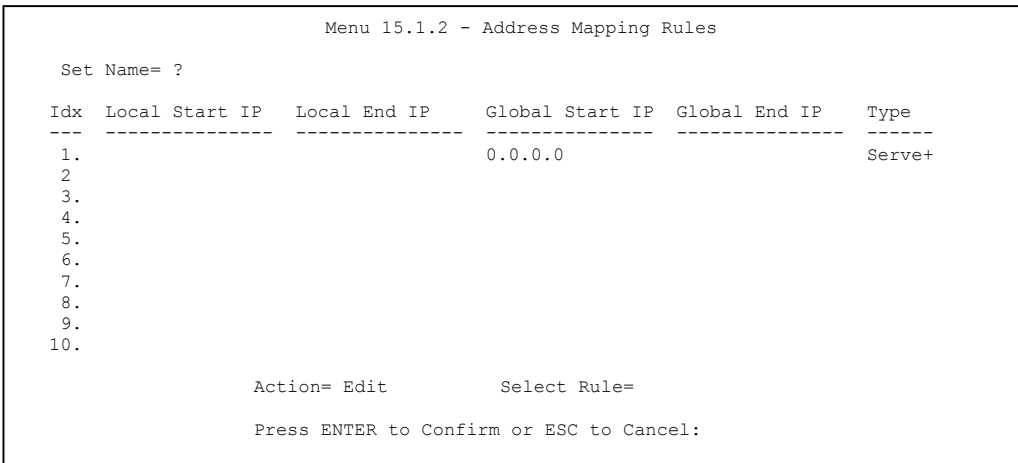

**Figure 19-6 Menu 15.1.2**

**If the Set Name field is left blank, the entire set will be deleted.**

**The Type, Local and Global Start/End IPs are configured in menu 15.1.1.1 (described later) and the values are displayed here.**

**Ordering Your Rules**

Ordering your rules is important because the Prestige applies the rules in the order that you specify. When a rule matches the current packet, the Prestige takes the corresponding action and the remaining rules are ignored. If there are any empty rules before your new configured rule, your configured rule will be pushed

up by that number of empty rules. For example, if you have already configured rules 1 to 6 in your current set and now you configure rule number 9. In the set summary screen, the new rule will be rule 7, not 9.

Now if you delete rule 4, rules 5 to 7 will be pushed up by 1 rule, so as old rule 5 becomes rule 4, old rule 6 becomes rule 5 and old rule 7 becomes rule 6.

**Table 19-3 Menu 15.1.2**

FIELD	DESCRIPTION	EXAMPLE
Set Name	Enter a name for this set of rules. This is a required field. If this field is left blank, the entire set will be deleted.	ACL Default Set
Action	The default is <b>Edit</b> . <b>Edit</b> means you want to edit a selected rule (see following field). <b>Insert Before</b> means to insert a rule before the rule selected. The rules after the selected rule will then be moved down by one rule. <b>Delete</b> means to delete the selected rule and then all the rules after the selected one will be advanced one rule. <b>None</b> disables the <b>Select Rule</b> item.	<b>Edit</b>
Select Rule	When you choose <b>Edit</b> , <b>Insert Before</b> or <b>Delete</b> in the previous field the cursor jumps to this field to allow you to select the rule to apply the action in question.	1

**You must press [ENTER] at the bottom of the screen to save the whole set. You must do this again if you make any changes to the set – including deleting a rule. No changes to the set take place until this action is taken.**

Selecting **Edit** in the **Action** field and then selecting a rule brings up the following menu, **Menu 15.1.1.1 - Address Mapping Rule** in which you can edit an individual rule and configure the **Type**, **Local** and **Global Start/End IPs**.

**An End IP address must be numerically greater than its corresponding IP Start address.**

```

Menu 15.1.1.1 Address Mapping Rule

Type= One-to-One

Local IP:
  Start=
  End = N/A

Global IP:
  Start= 0.0.0.0
  End = N/A

Server Mapping Set= N/A

Press ENTER to Confirm or ESC to Cancel:

Press Space Bar to Toggle.
    
```

**Figure 19-7 Menu 15.1.1.1 Editing/Configuring an Individual Rule in a Set**

The following table explains the fields in this menu.

**Table 19-4 Menu 15.1.1.1 Editing/Configuring an Individual Rule in a Set**

FIELD	DESCRIPTION	EXAMPLE
Type	Press [SPACE BAR] and then [ENTER] to select from a total of five types. These are the mapping types discussed in the chapter on NAT web configurator screens. <b>Server</b> allows you to specify multiple servers of different types behind NAT to this computer. See <i>section 19.5.3</i> for an example.	<b>One-to-One</b>
Local IP	Only local IP fields are <b>N/A</b> for server; Global IP fields <b>MUST</b> be set for <b>Server</b> .	
Start	This is the starting local IP address (ILA).	0.0.0.0
End	This is the ending local IP address (ILA). If the rule is for all local IPs, then put the Start IP as 0.0.0.0 and the End IP as 255.255.255.255. This field is <b>N/A</b> for One-to-One and Server types.	N/A
Global IP		
Start	This is the starting inside global IP address (IGA). If you have a dynamic IP, enter 0.0.0.0 as the <b>Global IP Start</b> . Note that <b>Global IP Start</b> can be set to 0.0.0.0 only if the types are <b>Many-to-One</b> or <b>Server</b> .	0.0.0.0
End	This is the ending inside global IP address (IGA). This field is <b>N/A</b> for <b>One-to-One</b> , <b>Many-to-One</b> and <b>Server</b> types.	N/A

**Table 19-4 Menu 15.1.1.1 Editing/Configuring an Individual Rule in a Set**

FIELD	DESCRIPTION	EXAMPLE
Server Mapping Set	Only available when <b>Type</b> is set to <b>Server</b> . Type a number from 1 to 10 to choose a server set from menu 15.2.	
When you have completed this menu, press [ENTER] at the prompt "Press ENTER to confirm or ESC to cancel" to save your configuration or press [ESC] to cancel and go back to the previous screen.		

## 19.4 Configuring a Server behind NAT

Follow these steps to configure a server behind NAT:

**Step 1.** Enter 15 in the main menu to go to **Menu 15 - NAT Setup**.

**Step 2.** Enter 2 to display **Menu 15.2 - NAT Server Sets** as shown next.

```

Menu 15.2 - NAT Server Sets

1. Server Set 1 (Used for SUA Only)
2. Server Set 2
3. Server Set 3
4. Server Set 4
5. Server Set 5
6. Server Set 6
7. Server Set 7
8. Server Set 8
9. Server Set 9
10. Server Set 10

Enter Set Number to Edit:

```

**Figure 19-8 Menu 15.2 NAT Server Setup**

**Step 3.** Enter 1 to go to **Menu 15.2.1 NAT Server Setup** as follows.

Menu 15.2.1 - NAT Server Setup			
Rule	Start Port No.	End Port No.	IP Address
1.	Default	Default	0.0.0.0
2.	21	25	192.168.1.33
3.	0	0	0.0.0.0
4.	0	0	0.0.0.0
5.	0	0	0.0.0.0
6.	0	0	0.0.0.0
7.	0	0	0.0.0.0
8.	0	0	0.0.0.0
9.	0	0	0.0.0.0
10.	0	0	0.0.0.0
11.	0	0	0.0.0.0
12.	0	0	0.0.0.0

Press ENTER to Confirm or ESC to Cancel:

**Figure 19-9 Menu 15.2.1 NAT Server Setup**

- Step 4.** Enter a port number in an unused **Start Port No** field. To forward only one port, enter it again in the **End Port No** field. To specify a range of ports, enter the last port to be forwarded in the **End Port No** field.
- Step 5.** Enter the inside IP address of the server in the **IP Address** field. In the following figure, you have a computer acting as an FTP, Telnet and SMTP server (ports 21, 23 and 25) at 192.168.1.33.
- Step 6.** Press [ENTER] at the “Press ENTER to confirm ...” prompt to save your configuration after you define all the servers or press [ESC] at any time to cancel.

## The NAT network appears as a single host on the Internet

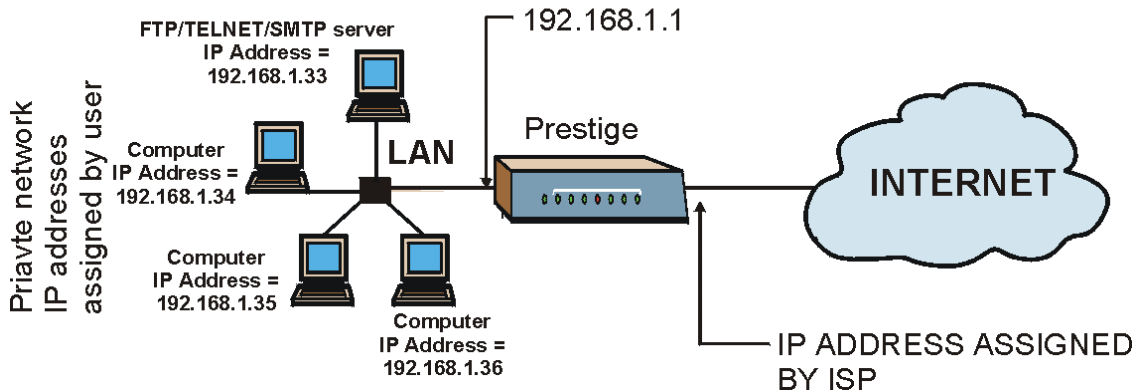

Figure 19-10 Multiple Servers Behind NAT Example

## 19.5 General NAT Examples

The following are some examples of NAT configuration.

### 19.5.1 Example 1: Internet Access Only

In the following Internet access example, you only need one rule where your ILAs (Inside Local addresses) all map to one dynamic IGA (Inside Global Address) assigned by your ISP.

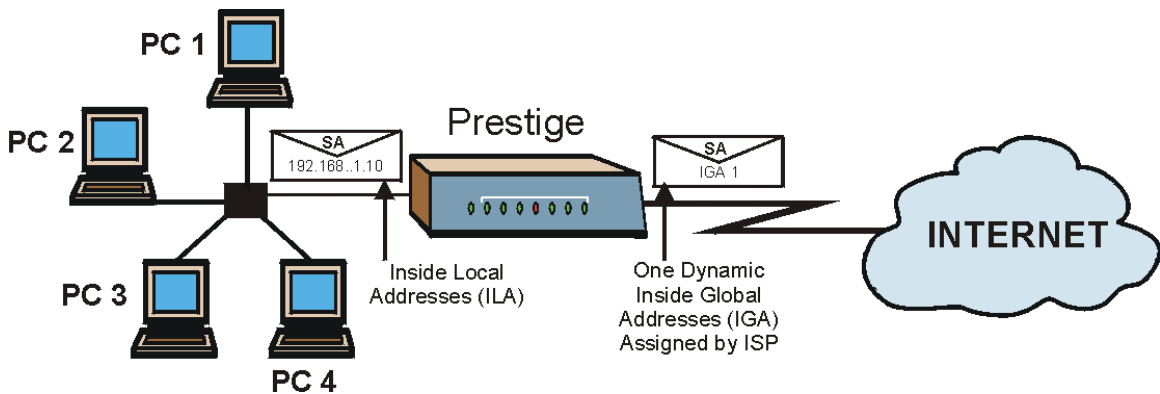

Figure 19-11 NAT Example 1

```

Menu 4 - Internet Access Setup

ISP's Name= MyISP
Encapsulation= RFC 1483
Multiplexing= LLC-based
VPI #= 8
VCI #= 35
ATM QoS Type= UBR
Peak Cell Rate (PCR)= 0
Sustain Cell Rate (SCR)= 0
Maximum Burst Size (MBS)= 0
My Login= N/A
My Password= N/A
ENET ENCAP Gateway= N/A
IP Address Assignment= Static
IP Address= 0.0.0.0
Network Address Translation= SUA Only
Address Mapping Set= N/A

Press ENTER to Confirm or ESC to Cancel:
    
```

Figure 19-12 Menu 4 Internet Access & NAT Example

From menu 4, choose the **SUA Only** option from the **Network Address Translation** field. This is the Many-to-One mapping discussed in *section 19.5*. The **SUA Only** read-only option from the **Network Address Translation** field in menus 4 and 11.3 is specifically pre-configured to handle this case.



## 19.5.2 Example 2: Internet Access with an Inside Server

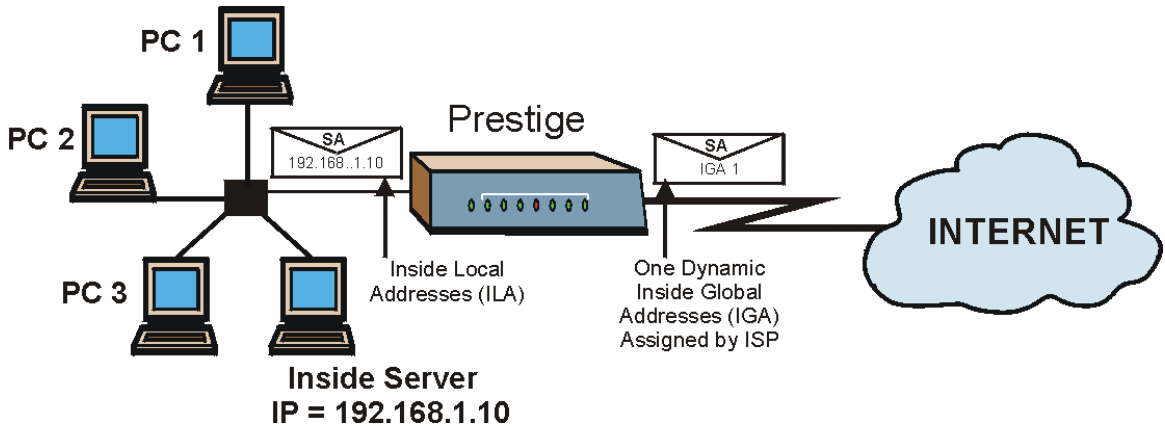

Figure 19-13 NAT Example 2

In this case, you do exactly as above (use the convenient pre-configured **SUA Only** set) and also go to menu 15.2 to specify the Inside Server behind the NAT as shown in the next figure.

Menu 15.2.1 - NAT Server Setup (Used for SUA Only)

Rule	Start Port No.	End Port No.	IP Address
1.	Default	Default	192.168.1.10
2.	0	0	0.0.0.0
3.	0	0	0.0.0.0
4.	0	0	0.0.0.0
5.	0	0	0.0.0.0
6.	0	0	0.0.0.0
7.	0	0	0.0.0.0
8.	0	0	0.0.0.0
9.	0	0	0.0.0.0
10.	0	0	0.0.0.0
11.	0	0	0.0.0.0
12.	0	0	0.0.0.0

Press ENTER to Confirm or ESC to Cancel:

Figure 19-14 Menu 15.2.1 Specifying an Inside Server

### 19.5.3 Example 3: Multiple Public IP Addresses With Inside Servers

In this example, there are 3 IGAs from our ISP. There are many departments but two have their own FTP server. All departments share the same router. The example will reserve one IGA for each department with an FTP server and all departments use the other IGA. Map the FTP servers to the first two IGAs and the other LAN traffic to the remaining IGA. Map the third IGA to an inside web server and mail server. Four rules need to be configured, two bi-directional and two uni-directional as follows.

- Rule 1.** Map the first IGA to the first inside FTP server for FTP traffic in both directions (**1 : 1** mapping, giving both local and global IP addresses).
- Rule 2.** Map the second IGA to our second inside FTP server for FTP traffic in both directions (**1 : 1** mapping, giving both local and global IP addresses).
- Rule 3.** Map the other outgoing LAN traffic to IGA3 (**Many : 1** mapping).
- Rule 4.** You also map your third IGA to the web server and mail server on the LAN. Type **Server** allows you to specify multiple servers, of different types, to other computers behind NAT on the LAN.

The example situation looks somewhat like this:

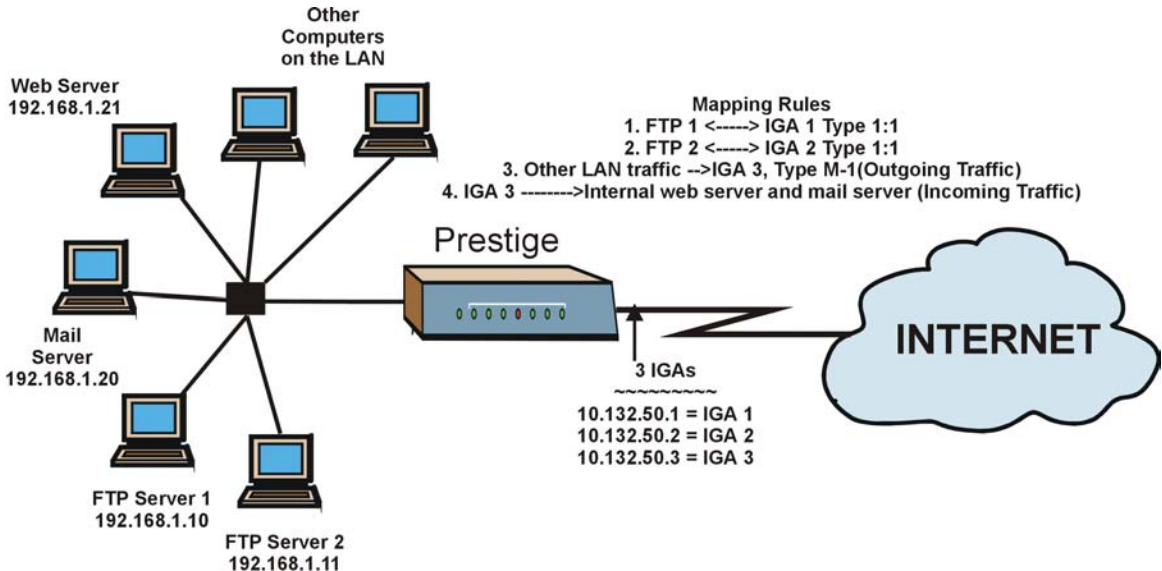

Figure 19-15 NAT Example 3

- Step 1.** In this case you need to configure Address Mapping Set 1 from **Menu 15.1 - Address Mapping Sets**. Therefore you must choose the **Full Feature** option from the **Network Address Translation** field (in menu 4 or menu 11.3) in *Figure 19-16*.
- Step 2.** Then enter 15 from the main menu.
- Step 3.** Enter 1 to configure the Address Mapping Sets.
- Step 4.** Enter 1 to begin configuring this new set. Enter a Set Name, choose the **Edit Action** and then enter 1 for the **Select Rule** field. Press [ENTER] to confirm.
- Step 5.** Select **Type** as **One-to-One** (direct mapping for packets going both ways), and enter the local **Start IP** as 192.168.1.10 (the IP address of FTP Server 1), the global **Start IP** as 10.132.50.1 (our first IGA). (See *Figure 19-17*).
- Step 6.** Repeat the previous step for rules 2 to 4 as outlined above.
- Step 7.** When finished, menu 15.1.1 should look like as shown in .

```
Menu 11.3 - Remote Node Network Layer Options

IP Options:                               Bridge Options:
IP Address Assignment= Static             Ethernet Addr Timeout (min)= 0
Rem IP Addr: 0.0.0.0
Rem Subnet Mask= 0.0.0.0
My WAN Addr= 0.0.0.0
NAT= Full Feature
  Address Mapping Set= 2
Metric= 2
Private= No
RIP Direction= Both
  Version= RIP-2B
Multicast= IGMP-v2
IP Policies=

Press ENTER to Confirm or ESC to Cancel:
```

**Figure 19-16 Example 3: Menu 11.3**

The following figures show how to configure the first rule

```

Menu 15.1.1.1 Address Mapping Rule

Type= One-to-One

Local IP:
  Start= 192.168.1.10
  End = N/A

Global IP:
  Start= 10.132.50.1
  End = N/A

Server Mapping Set= N/A

Press ENTER to Confirm or ESC to Cancel:

Press Space Bar to Toggle.
    
```

**Figure 19-17 Example 3: Menu 15.1.1.1**

```

Menu 15.1.1 - Address Mapping Rules

Set Name= Example3

Idx  Local Start IP  Local End IP  Global Start IP  Global End IP  Type
-----
1.  192.168.1.10      10.132.50.1   1-1
2.  192.168.1.11     10.132.50.2   1-1
3.  0.0.0.0           255.255.255.255 10.132.50.3   M-1
4.  10.132.50.3      Server
5.
6.
7.
8.
9.
10.

Action= Edit      Select Rule=

Press ENTER to Confirm or ESC to Cancel:
    
```

**Figure 19-18 Example 3: Final Menu 15.1.1**

Now configure the IGA3 to map to our web server and mail server on the LAN.

**Step 8.** Enter 15 from the main menu.

**Step 9.** Enter 2 in **Menu 15 - NAT Setup**.

**Step 10.** Enter 1 in **Menu 15.2 - NAT Server Sets** to see the following menu. Configure it as shown.

Menu 15.2.1 - NAT Server Setup

Rule	Start Port No.	End Port No.	IP Address
1.	Default	Default	0.0.0.0
2.	80	80	192.168.1.21
3.	25	25	192.168.1.20
4.	0	0	0.0.0.0
5.	0	0	0.0.0.0
6.	0	0	0.0.0.0
7.	0	0	0.0.0.0
8.	0	0	0.0.0.0
9.	0	0	0.0.0.0
10.	0	0	0.0.0.0
11.	0	0	0.0.0.0
12.	0	0	0.0.0.0

Press ENTER to Confirm or ESC to Cancel:

**Example 3: Menu 15.2.1**

### 19.5.4 Example 4: NAT Unfriendly Application Programs

Some applications do not support NAT Mapping using TCP or UDP port address translation. In this case it is better to use **Many-to-Many No Overload** mapping as port numbers do *not* change for **Many-to-Many No Overload** (and **One-to-One**) NAT mapping types. The following figure illustrates this.

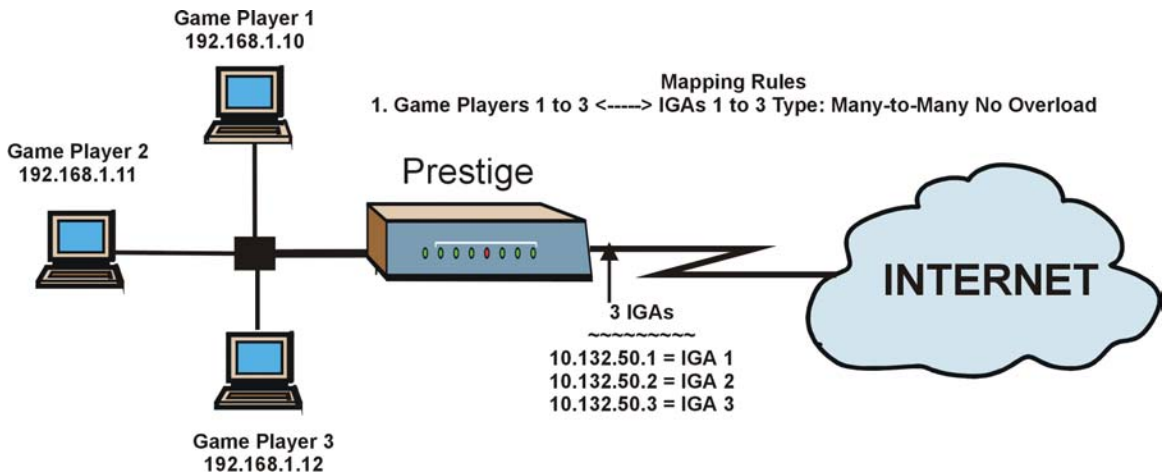

**Figure 19-19 NAT Example 4**

**Other applications such as some gaming programs are NAT unfriendly because they embed addressing information in the data stream. These applications won't work through NAT even when using One-to-One and Many-to-Many No Overload mapping types.**

Follow the steps outlined in example 3 to configure these two menus as follows.

```

Menu 15.1.1.1 Address Mapping Rule

Type= Many-to-Many No Overload

Local IP:
  Start= 192.168.1.10
  End = 192.168.1.12

Global IP:
  Start= 10.132.50.1
  End = 10.132.50.3

Server Mapping Set= N/A

Press ENTER to Confirm or ESC to Cancel:
    
```

**Figure 19-20 Example 4: Menu 15.1.1.1 Address Mapping Rule**

After you've configured your rule, you should be able to check the settings in menu 15.1.1 as shown next.

```

Menu 15.1.1 - Address Mapping Rules

Set Name= Example4

Idx  Local Start IP  Local End IP  Global Start IP  Global End IP  Type
----  -
1.   192.168.1.10    192.168.1.12  10.132.50.1     10.132.50.3   M:M NO OV
2.
3.
4.
5.
6.
7.
8.
9.
10.

Action= Edit          Select Rule=

Press ENTER to Confirm or ESC to Cancel:
    
```

**Figure 19-21 Example 4: Menu 15.1.1 Address Mapping Rules**

---

# Part VII:

---

## SMT Advanced Management

---

This part discusses filtering setup, SNMP, system information and diagnosis, firmware and configuration file maintenance, system maintenance, remote management, IP policy routing and call scheduling.

**See the web configurator parts of this guide for background information on features configurable by web configurator and SMT.**





# Chapter 20

## Filter Configuration

*This chapter shows you how to create and apply filters.*

### 20.1 About Filtering

Your Prestige uses filters to decide whether or not to allow passage of a data packet and/or to make a call. There are two types of filter applications: data filtering and call filtering. Filters are subdivided into device and protocol filters, which are discussed later.

Data filtering screens data to determine if the packet should be allowed to pass. Data filters are divided into incoming and outgoing filters, depending on the direction of the packet relative to a port. Data filtering can be applied on either the WAN side or the Ethernet side. Call filtering is used to determine if a packet should be allowed to trigger a call.

Outgoing packets must undergo data filtering before they encounter call filtering. Call filters are divided into two groups, the built-in call filters and user-defined call filters. Your Prestige has built-in call filters that prevent administrative, for example, RIP packets from triggering calls. These filters are always enabled and not accessible to you. Your Prestige applies the built-in filters first and then the user-defined call filters, if applicable, as shown next.

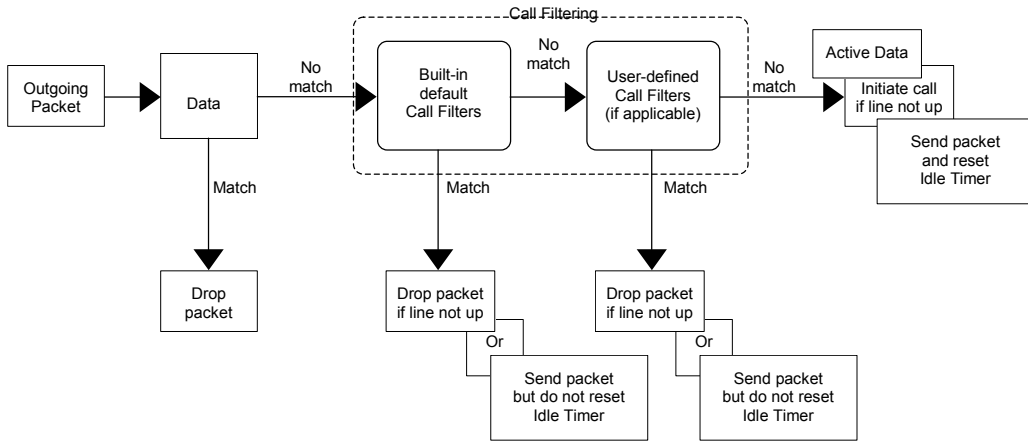

**Figure 20-1 Outgoing Packet Filtering Process**

Two sets of factory filter rules have been configured in menu 21 to prevent NetBIOS traffic from triggering calls. A summary of their filter rules is shown in the figures that follow.

The following figure illustrates the logic flow when executing a filter rule.

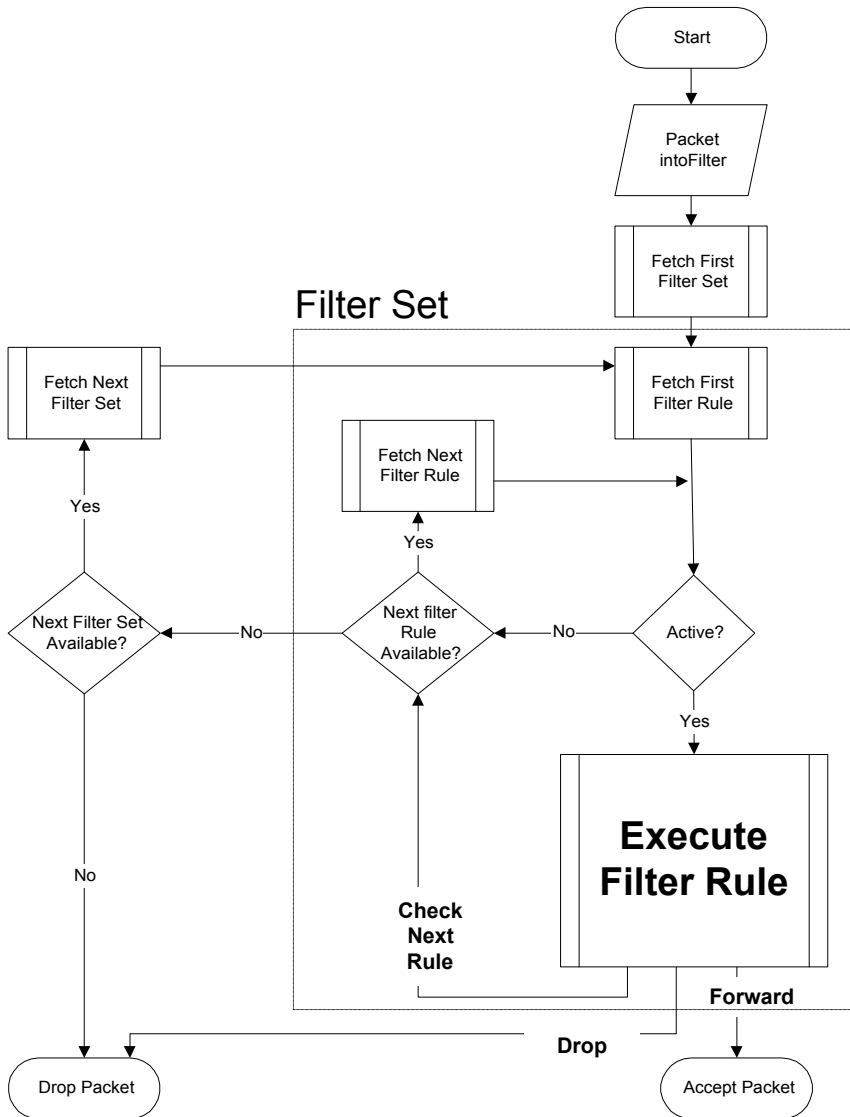

**Figure 20-2 Filter Rule Process**

You can apply up to four filter sets to a particular port to block various types of packets. Because each filter set can have up to six rules, you can have a maximum of 24 rules active for a single port.

For incoming packets, your Prestige applies data filters only. Packets are processed depending on whether a match is found. The following sections describe how to configure filter sets.

### The Filter Structure of the Prestige

A filter set consists of one or more filter rules. Usually, you would group related rules, for example, all the rules for NetBIOS, into a single set and give it a descriptive name. You can configure up to twelve filter sets with six rules in each set, for a total of 72 filter rules in the system.

## 20.2 Configuring a Filter Set

To configure a filter set, follow the steps shown next.

**Step 1.** Enter 21 in the main menu to display **Menu 21 – Filter Set Configuration**.

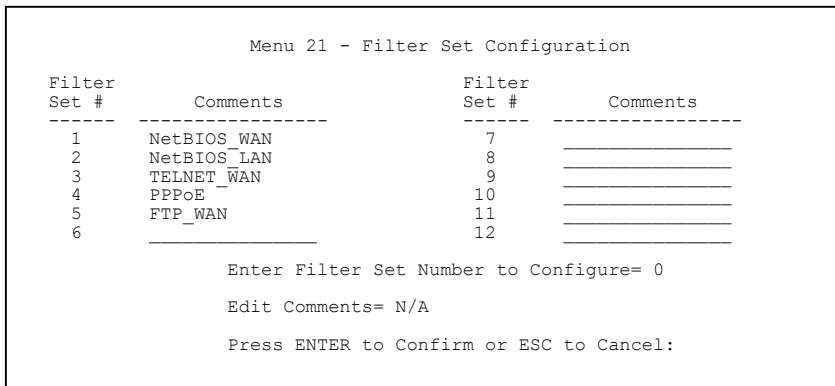

**Figure 20-3 Menu 21 Filter Set Configuration**

**Step 2.** Type the filter set to configure (no. 1 to 12) and press [ENTER].

**Step 3.** Type a descriptive name or comment in the **Edit Comments** field and press [ENTER].

**Step 4.** Press [ENTER] at the message “Press ENTER to confirm...” to display **Menu 21.1 – Filter Rules Summary** (that is, if you selected filter set 1 in menu 21).

```

Menu 21.1 - Filter Rules Summary

# A Type                Filter Rules                M m n
- - - - -              - - - - -              - - -
1 Y IP  Pr=6, SA=0.0.0.0, DA=0.0.0.0, DP=137      N D N
2 Y IP  Pr=6, SA=0.0.0.0, DA=0.0.0.0, DP=138      N D N
3 Y IP  Pr=6, SA=0.0.0.0, DA=0.0.0.0, DP=139      N D N
4 Y IP  Pr=17, SA=0.0.0.0, DA=0.0.0.0, DP=137     N D N
5 Y IP  Pr=17, SA=0.0.0.0, DA=0.0.0.0, DP=138     N D N
6 Y IP  Pr=17, SA=0.0.0.0, DA=0.0.0.0, DP=139     N D F

Enter Filter Rule Number (1-6) to Configure:

```

**Figure 20-4 NetBIOS\_WAN Filter Rules Summary**

```

Menu 21.2 - Filter Rules Summary

# A Type                Filter Rules                M m n
- - - - -              - - - - -              - - -
1 Y IP  Pr=17, SA=0.0.0.0, SP=137, DA=0.0.0.0, DP=53  N D F
2 N
3 N
4 N
5 N
6 N

Enter Filter Rule Number (1-6) to Configure:

```

**Figure 20-5 NetBIOS\_LAN Filter Rules Summary**

```

Menu 21.3 - Filter Rules Summary

# A Type                Filter Rules                M m n
- - - - -              - - - - -              - - -
1 Y IP  Pr=6, SA=0.0.0.0, DA=0.0.0.0, DP=23        N D F
2 N
3 N
4 N
5 N
6 N

Enter Filter Rule Number (1-6) to Configure:

```

**Figure 20-6 TELNET\_WAN Filter Rules Summary**

```

Menu 21.4 - Filter Rules Summary

# A Type                Filter Rules                M m n
- - - - -
1 Y Gen  Off=12, Len=2, Mask=ffff, Value=8863      N F N
2 Y Gen  Off=12, Len=2, Mask=ffff, Value=8864      N F D
3 N
4 N
5 N
6 N

Enter Filter Rule Number (1-6) to Configure:
    
```

**Figure 20-7 PPPoE Filter Rules Summary**

```

Menu 21.5 - Filter Rules Summary

# A Type                Filter Rules                M m n
- - - - -
1 Y IP   Pr=6, SA=0.0.0.0, DA=0.0.0.0, DP=21      N D F
2 N
3 N
4 N
5 N
6 N

Enter Filter Rule Number (1-6) to Configure:
    
```

**Figure 20-8 FTP\_WAN Filter Rules Summary**

## 20.2.1 Filter Rules Summary Menus

The following tables briefly describe the abbreviations used in menu 21.x.

**Table 20-1 Abbreviations Used in the Filter Rules Summary Menu**

FIELD	DESCRIPTION
#	The filter rule number: 1 to 6.
A	Active: "Y" means the rule is active. "N" means the rule is inactive.
Type	The type of filter rule: "GEN" for Generic, "IP" for TCP/IP.
Filter Rules	These parameters are displayed here.

**Table 20-1 Abbreviations Used in the Filter Rules Summary Menu**

FIELD	DESCRIPTION
M	More. “Y” means there are more rules to check which form a rule chain with the present rule. An action cannot be taken until the rule chain is complete.  “N” means there are no more rules to check. You can specify an action to be taken for instance, forward the packet, drop the packet or check the next rule. For the latter, the next rule is independent of the rule just checked.
m	Action Matched. “F” means to forward the packet immediately and skip checking the remaining rules. “D” means to drop the packet. “N” means to check the next rule.
n	Action Not Matched. “F” means to forward the packet immediately and skip checking the remaining rules. “D” means to drop the packet. “N” means to check the next rule.

The protocol dependent filter rules abbreviation are listed as follows:

**Table 20-2 Rule Abbreviations Used**

FILTER TYPE	DESCRIPTION
IP	
Pr	Protocol
SA	Source Address
SP	Source Port Number
DA	Destination Address
DP	Destination Port Number
GEN	
Off	Offset
Len	Length

## 20.3 Configuring a Filter Rule

To configure a filter rule, type its number in **Menu 21.x – Filter Rules Summary** and press [ENTER] to open menu 21.x.1 for the rule.

There are two types of filter rules: **TCP/IP** and **Generic**. Depending on the type of rule, the parameters for each type will be different. Use [SPACE BAR] to select the type of rule that you want to create in the **Filter Type** field and press [ENTER] to open the respective menu.

To speed up filtering, all rules in a filter set must be of the same class, for instance, protocol filters or generic filters. The class of a filter set is determined by the first rule that you create. When applying the filter sets to a port, separate menu fields are provided for protocol and device filter sets. If you include a protocol filter set in a device filters field or vice versa, the Prestige will warn you and will not allow you to save.

### 20.3.1 TCP/IP Filter Rule

This section shows you how to configure a TCP/IP filter rule. TCP/IP rules allow you to base the rule on the fields in the IP and the upper layer protocol, for example, UDP and TCP headers.

To configure TCP/IP rules, select TCP/IP Filter Rule from the **Filter Type** field and press [ENTER] to open **Menu 21.x.1 – TCP/IP Filter Rule**, as shown next.

```
Menu 21.6.1 - TCP/IP Filter Rule

Filter #: 6,1
Filter Type= TCP/IP Filter Rule
Active= No
IP Protocol= 0      IP Source Route= No
Destination: IP Addr=
              IP Mask=
              Port #=
              Port # Comp= None
Source:       IP Addr=
              IP Mask=
              Port #=
              Port # Comp= None
TCP Estab= N/A
More= No      Log= None
Action Matched= Check Next Rule
Action Not Matched= Check Next Rule

Press ENTER to Confirm or ESC to Cancel:
Press Space Bar to Toggle.
```

**Figure 20-9 Menu 21.x.1 TCP/IP Filter Rule**

The following table describes how to configure your TCP/IP filter rule.



**Table 20-3 Menu 21.x.1 TCP/IP Filter Rule**

<b>FIELD</b>	<b>DESCRIPTION</b>	<b>EXAMPLE</b>
Filter #	This is the filter set, filter rule coordinates, for instance, 2, 3 refers to the second filter set and the third filter rule of that set.	6,1
Filter Type	Use [SPACE BAR] and then [ENTER] to choose a rule. Parameters displayed for each type will be different. Choices are <b>TCP/IP Filter Rule</b> or <b>Generic Filter Rule</b> .	<b>TCP/IP Filter Rule</b>
Active	Select <b>Yes</b> to activate or <b>No</b> to deactivate the filter rule.	<b>No</b> (default)
IP Protocol	This is the upper layer protocol, for example, TCP is 6, UDP is 17 and ICMP is 1. The value must be between 0 and 255. A value of 0 matches ANY protocol.	0 to 255
IP Source Route	IP Source Route is an optional header that dictates the route an IP packet takes from its source to its destination. If <b>Yes</b> , the rule applies to any packet with an IP source route. The majority of IP packets do not have source route.	<b>No</b> (default)
Destination: IP Addr	Type the destination IP address of the packet you want to filter. This field is ignored if it is 0.0.0.0.	IP address
IP Mask	Type the IP mask to apply to the Destination: IP Addr field.	IP mask
Port #	Type the destination port of the packets you want to filter. The field range is 0 to 65535. A 0 field is ignored.	0 to 65535
Port # Comp	Select the comparison to apply to the destination port in the packet against the value given in <b>Destination: Port #</b> . Choices are <b>None</b> , <b>Less</b> , <b>Greater</b> , <b>Equal</b> or <b>Not Equal</b> .	<b>None</b>
Source: IP Addr	Type the source IP Address of the packet you want to filter. A 0.0.0.0 field is ignored.	IP address
IP Mask	Type the IP mask to apply to the <b>Source: IP Addr</b> field.	IP mask
Port #	Type the source port of the packets you want to filter. The range of this field is 0 to 65535. A 0 field is ignored.	0 to 65535
Port # Comp	Select the comparison to apply to the source port in the packet against the value given in <b>Source: Port #</b> field. Choices are <b>None</b> , <b>Less</b> , <b>Greater</b> , <b>Equal</b> or <b>Not Equal</b> .	<b>None</b>

**Table 20-3 Menu 21.x.1 TCP/IP Filter Rule**

<b>FIELD</b>	<b>DESCRIPTION</b>	<b>EXAMPLE</b>
TCP Estab	This applies only when the IP Protocol field is 6, TCP. If <b>Yes</b> , the rule matches packets that want to establish TCP connection(s) (SYN=1 and ACK=0); else it is ignored.	<b>No</b> (default)
More	If <b>Yes</b> , a matching packet is passed to the next filter rule before an action is taken or else the packet is disposed of according to the action fields.  If <b>More</b> is <b>Yes</b> , then <b>Action Matched</b> and <b>Action Not Matched</b> will be N/A.	<b>No</b> (default)
Log	Select the logging option from the following:  <b>None</b> – No packets will be logged.  <b>Action Matched</b> – Only packets that match the rule parameters will be logged.  <b>Action Not Matched</b> – Only packets that do not match the rule parameters will be logged.  <b>Both</b> – All packets will be logged.	<b>None</b>
Action Matched	Select the action for a matching packet. Choices are <b>Check Next Rule, Forward</b> or <b>Drop</b> .	<b>Check Next Rule</b> (default)
Action Not Matched	Select the action for a packet not matching the rule. Choices are <b>Check Next Rule, Forward</b> or <b>Drop</b> .	<b>Check Next Rule</b> (default)
When you have completed this menu, press [ENTER] at the prompt "Press ENTER to confirm or ESC to cancel" to save your configuration or press [ESC] to cancel and go back to the previous screen.		

The following figure illustrates the logic flow of an IP filter.

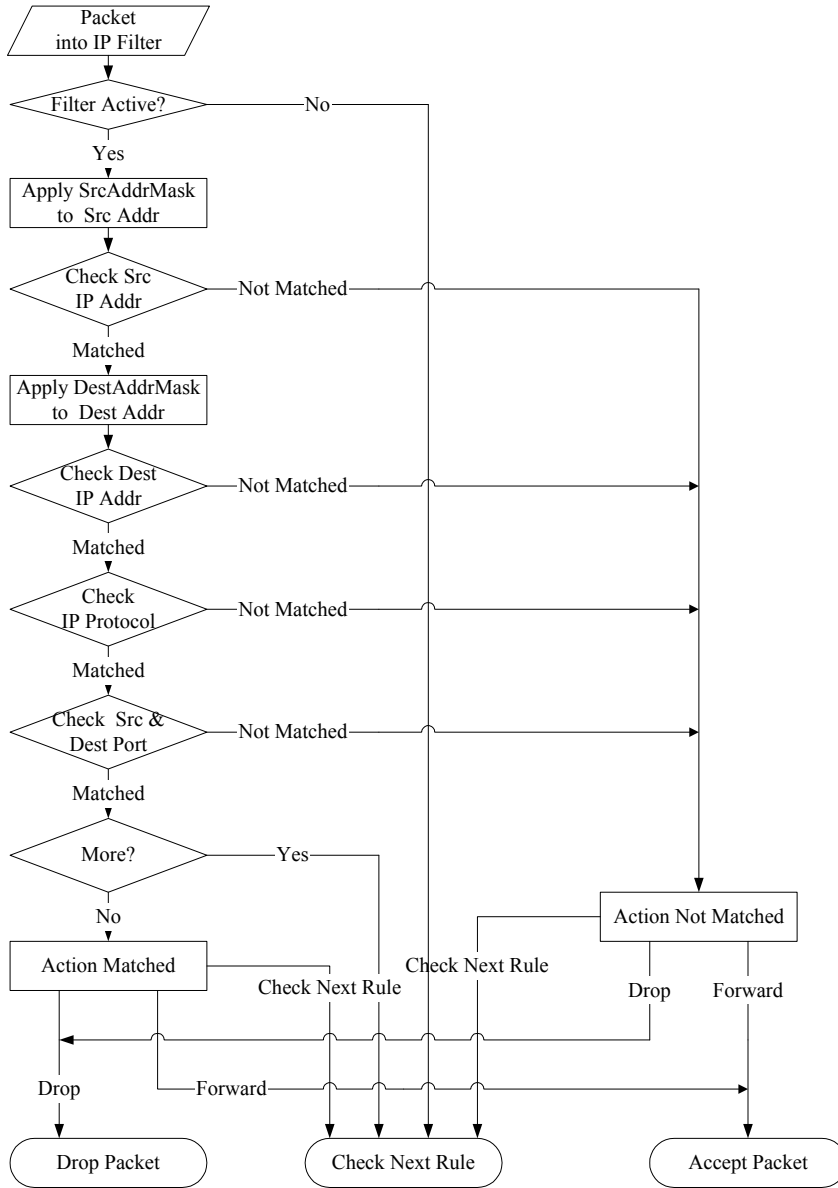

Figure 20-10 Executing an IP Filter

## 20.3.2 Generic Filter Rule

This section shows you how to configure a generic filter rule. The purpose of generic rules is to allow you to filter non-IP packets. For IP, it is generally easier to use the IP rules directly.

For generic rules, the Prestige treats a packet as a byte stream as opposed to an IP packet. You specify the portion of the packet to check with the **Offset** (from 0) and the **Length** fields, both in bytes. The Prestige applies the Mask (bit-wise ANDing) to the data portion before comparing the result against the Value to determine a match. The **Mask** and **Value** fields are specified in hexadecimal numbers. Note that it takes two hexadecimal digits to represent a byte, so if the length is 4, the value in either field will take 8 digits, for example, FFFFFFFF.

To configure a generic rule select an empty filter set in menu 21, for example 6. Select **Generic Filter Rule** in the **Filter Type** field and press [ENTER] to open **Menu 21.6.1 – Generic Filter Rule**, as shown in the following figure.

```
Menu 21.6.1 - Generic Filter Rule

Filter #: 6,1
Filter Type= Generic Filter Rule
Active= No
Offset= 0
Length= 0
Mask= N/A
Value= N/A
More= No           Log= None
Action Matched= Check Next Rule
Action Not Matched= Check Next Rule

Press ENTER to Confirm or ESC to Cancel:

Press Space Bar to Toggle.
```

**Figure 20-11 Menu 21.6.1 Generic Filter Rule**

The next table describes the fields in the **Generic Filter Rule** menu.

**Table 20-4 Menu 21.6.1 Generic Filter Rule**

<b>FIELD</b>	<b>DESCRIPTION</b>	<b>EXAMPLE</b>
Filter #	This is the filter set, filter rule coordinates, for instance, 2, 3 refers to the second filter set and the third rule of that set.	6,1
Filter Type	Press [SPACE BAR] and then [ENTER] to select a type of rule. Parameters displayed below each type will be different. Choices are <b>Generic Filter Rule</b> or <b>TCP/IP Filter Rule</b> .	<b>Generic Filter Rule</b>
Active	Select <b>Yes</b> to turn on or <b>No</b> to turn off the filter rule.	<b>No</b> (default)
Offset	Type the starting byte of the data portion in the packet that you want to compare. The range for this field is from 0 to 255.	0 (default)
Length	Type the byte count of the data portion in the packet that you want to compare. The range for this field is 0 to 8.	0 (default)
Mask	Type the mask (in Hexadecimal) to apply to the data portion before comparison.	
Value	Type the value (in Hexadecimal) to compare with the data portion.	
More	If <b>Yes</b> , a matching packet is passed to the next filter rule before an action is taken or else the packet is disposed of according to the action fields.  If <b>More</b> is <b>Yes</b> , then <b>Action Matched</b> and <b>Action Not Matched</b> will be <b>N/A</b> .	<b>No</b> (default)
Log	Select the logging option from the following:  <b>None</b> – No packets will be logged. <b>Action Matched</b> – Only matching packets and rules will be logged. <b>Action Not Matched</b> – Only packets that do not match the rule parameters will be logged. <b>Both</b> – All packets will be logged.	<b>None</b>
Action Matched	Select the action for a matching packet. Choices are <b>Check Next Rule</b> , <b>Forward</b> or <b>Drop</b> .	<b>Check Next Rule</b> (default)
Action Not Matched	Select the action for a packet not matching the rule. Choices are <b>Check Next Rule</b> , <b>Forward</b> or <b>Drop</b> .	<b>Check Next Rule</b> (default)
When you have completed this menu, press [ENTER] at the prompt "Press ENTER to confirm or ESC to cancel" to save your configuration or press [ESC] to cancel and go back to the previous screen.		

## 20.4 Filter Types and NAT

There are two classes of filter rules, **Generic Filter** Device rules and Protocol Filter (**TCP/IP**) rules. Generic Filter rules act on the raw data from/to LAN and WAN. Protocol Filter rules act on IP packets.

When NAT (Network Address Translation) is enabled, the inside IP address and port number are replaced on a connection-by-connection basis, which makes it impossible to know the exact address and port on the wire. Therefore, the Prestige applies the protocol filters to the “native” IP address and port number before NAT for outgoing packets and after NAT for incoming packets. On the other hand, the generic (or device) filters are applied to the raw packets that appear on the wire. They are applied at the point where the Prestige is receiving and sending the packets; for instance, the interface. The interface can be an Ethernet, or any other hardware port. The following figure illustrates this.

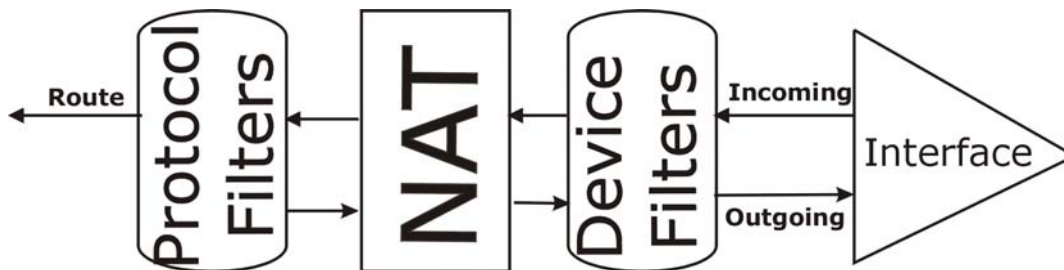
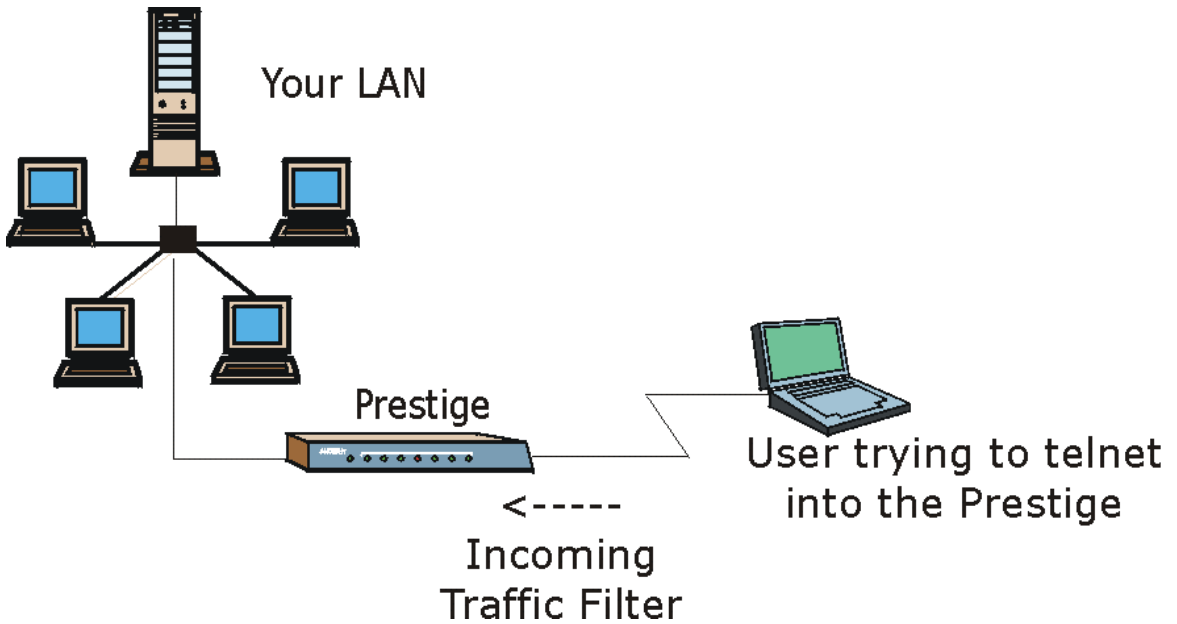

Figure 20-12 Protocol and Device Filter Sets

## 20.5 Example Filter

Let's look at an example to block outside users from telnetting into the Prestige.



**Figure 20-13 Sample Telnet Filter**

- Step 1.** Enter 21 in the main menu to display **Menu 21 — Filter Set Configuration**.
- Step 2.** Enter the index number of the filter set you want to configure (in this case 3).
- Step 3.** Type a descriptive name or comment in the **Edit Comments** field (for example, TELNET\_WAN) and press [ENTER].

**Step 4.** Press [ENTER] at the message “Press [ENTER] to confirm or [ESC] to cancel” to open **Menu 21.3 — Filter Rules Summary.**

**Step 5.** Type 1 to configure the first filter rule. Make the entries in this menu as shown next.

When you press [ENTER] to confirm, the following screen appears. Note that there is only one filter rule in this set.

```

Menu 21.3.1 - TCP/IP Filter Rule

Filter #: 3,1
Filter Type= TCP/IP Filter Rule
Active= Yes
IP Protocol= 6          IP Source Route= No
Destination: IP Addr= 0.0.0.0
              IP Mask= 0.0.0.0
              Port # = 23
              Port # Comp= Equal
Source: IP Addr= 0.0.0.0
        IP Mask= 0.0.0.0
        Port # =
        Port # Comp= Equal
TCP Estab= No
More= No          Log= None
Action Matched= Drop
Action Not Matched= Forward

Press ENTER to Confirm or ESC to Cancel:
    
```

Press [SPACE BAR] to choose this filter rule type. The first filter rule type determines all subsequent filter types within a set.

Select **Yes** to make the rule active.

**6** is the TCP protocol.

The port number for the telnet service (TCP protocol) is **23**. See RFC-1060 for port numbers of well-known services.

There are no more rules to check.

Select **Drop** here so that the packet will be dropped if its destination is the telnet port.

Select **Equal** here as we are looking for packets going to port 23 only.

Select **Forward** here so that the packet will be forwarded if its destination is not the telnet port and there are no more rules in this filter set to check. Select **Next** if there are more rules to check.

**Figure 20-14 Menu 21.3.1 Sample Filter**



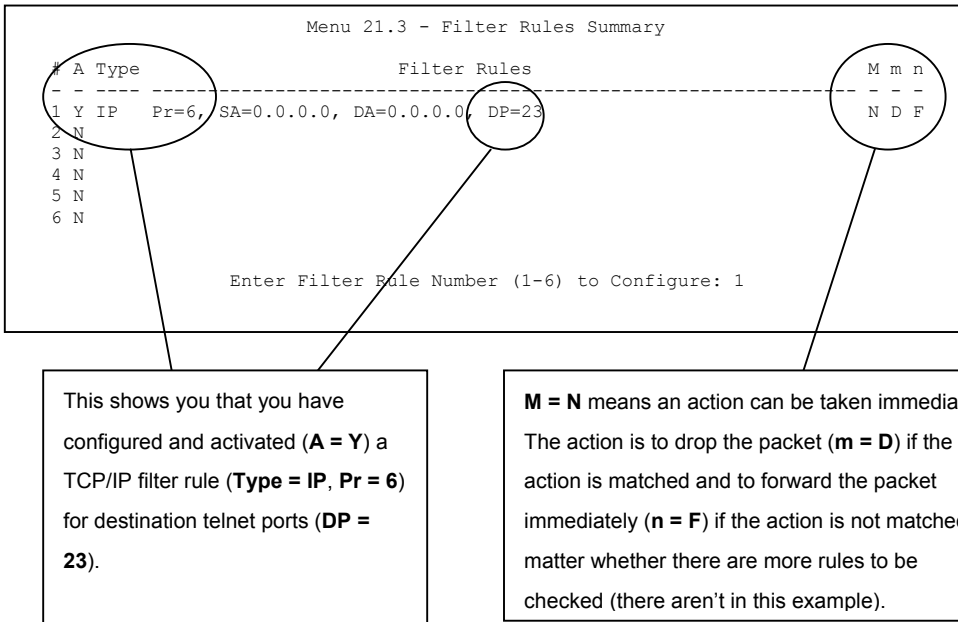

**Figure 20-15 Menu 21.3 Sample Filter Rules Summary**

After you have created the filter set, you must apply it.

- Step 1.** Enter 11 in the main menu to display menu 11 and type the remote node number to edit.
- Step 2.** Go to the **Edit Filter Sets** field, press [SPACE BAR] to choose **Yes** and press [ENTER].
- Step 3.** This brings you to menu 11.5. Apply the example filter set (for example, filter set 3) in this menu as shown in the next section.

## 20.6 Applying Filters and Factory Defaults

This section shows you where to apply the filter(s) after you design it (them). Sets of factory default filter rules have been configured in menu 21 (but have not been applied) to filter traffic.

**Table 20-5 Filter Sets Table**

FILTER SETS	DESCRIPTION
Input Filter Sets:	Apply filters for incoming traffic. You may apply protocol or device filter rules. See earlier in this chapter for information on filters.
Output Filter Sets:	Apply filters for traffic leaving the Prestige. You may apply filter rules for protocol or device filters. See earlier in this section for information on types of filters.
Call Filter Sets:	Apply filters to decide if a packet should be allowed to trigger a call.

### 20.6.1 Ethernet Traffic

You seldom need to filter Ethernet traffic; however, the filter sets may be useful to block certain packets, reduce traffic and prevent security breaches. Go to menu 3.1 (shown next) and type the number(s) of the filter set(s) that you want to apply as appropriate. You can choose up to four filter sets (from twelve) by typing their numbers separated by commas, for example, 2, 4, 6, 11. The factory default filter set, NetBIOS\_LAN, is inserted in the **protocol filters** field under **Input Filter Sets** in menu 3.1 in order to prevent local NetBIOS messages from triggering calls to the DNS server.

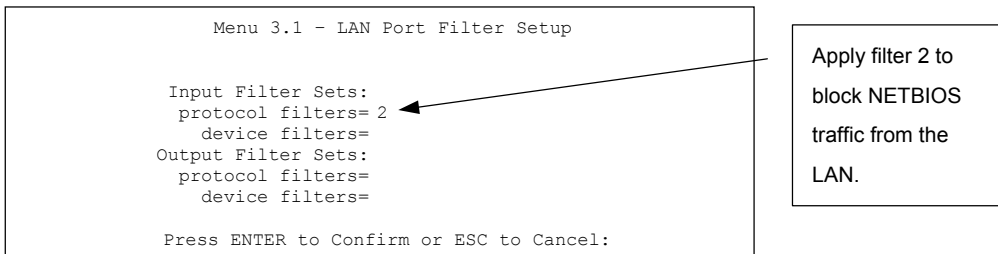

**Figure 20-16 Filtering Ethernet Traffic**

### 20.6.2 Remote Node Filters

Go to menu 11.5 (shown next) and type the number(s) of the filter set(s) as appropriate. You can cascade up to four filter sets by typing their numbers separated by commas. The factory default filter set, NetBIOS\_WAN, is inserted in the **protocol filters** field under **Call Filter Sets** in menu 11.5 to block local NetBIOS traffic from triggering calls to the ISP.

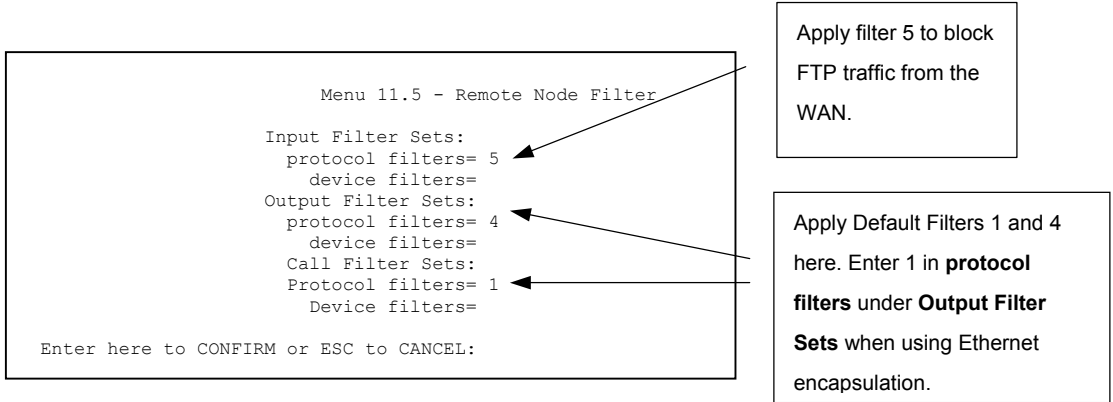

**Figure 20-17 Filtering Remote Node Traffic**

Note that call filter sets are visible when you select PPPoA or PPPoE encapsulation.



# Chapter 21

## SNMP Configuration

*This chapter explains SNMP Configuration menu 22.*

### 21.1 SNMP Overview

Simple Network Management Protocol is a protocol used for exchanging management information between network devices. SNMP is a member of the TCP/IP protocol suite. Your Prestige supports SNMP agent functionality, which allows a manager station to manage and monitor the Prestige through the network. The Prestige supports SNMP version one (SNMPv1) and version two c (SNMPv2c). The next figure illustrates an SNMP management operation. SNMP is only available if TCP/IP is configured.

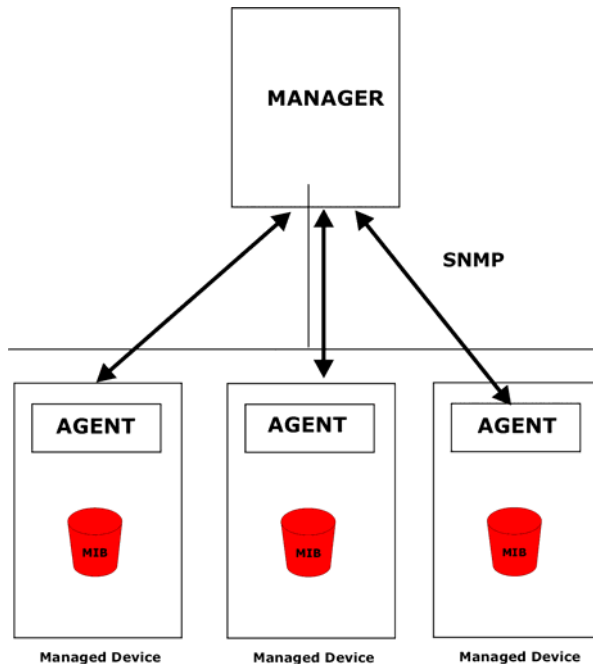

**Figure 21-1 SNMP Management Model**

An SNMP managed network consists of two main components: agents and a manager.

An agent is a management software module that resides in a managed device (the Prestige). An agent translates the local management information from the managed device into a form compatible with SNMP. The manager is the console through which network administrators perform network management functions. It executes applications that control and monitor managed devices.

The managed devices contain object variables/managed objects that define each piece of information to be collected about a device. Examples of variables include the number of packets received, node port status etc. A Management Information Base (MIB) is a collection of managed objects. SNMP allows a manager and agents to communicate for the purpose of accessing these objects.

SNMP itself is a simple request/response protocol based on the manager/agent model. The manager issues a request and the agent returns responses using the following protocol operations:

- Get - Allows the manager to retrieve an object variable from the agent.
- GetNext - Allows the manager to retrieve the next object variable from a table or list within an agent. In SNMPv1, when a manager wants to retrieve all elements of a table from an agent, it initiates a Get operation, followed by a series of GetNext operations.
- Set - Allows the manager to set values for object variables within an agent.
- Trap - Used by the agent to inform the manager of some events.

## 21.2 Supported MIBs

The Prestige supports RFC-1215 and MIB II as defined in RFC-1213 as well as ZyXEL private MIBs. The focus of the MIBs is to let administrators collect statistic data and monitor status and performance.

## 21.3 SNMP Configuration

To configure SNMP, select option 22 from the main menu to open **Menu 22 — SNMP Configuration** as shown next. The “community” for Get, Set and Trap fields is SNMP terminology for password.

```

Menu 22 - SNMP Configuration

SNMP:
  Get Community= public
  Set Community= public
  Trusted Host= 0.0.0.0
  Trap:
    Community= public
    Destination= 0.0.0.0

Press ENTER to Confirm or ESC to Cancel:

```

**Figure 21-2 Menu 22 SNMP Configuration**

The following table describes the SNMP configuration parameters.

**Table 21-1 Menu 22 SNMP Configuration**

FIELD	DESCRIPTION	EXAMPLE
SNMP:		
Get Community	Type the <b>Get Community</b> , which is the password for the incoming Get- and GetNext requests from the management station.	public
Set Community	Type the <b>Set</b> community, which is the password for incoming Set requests from the management station.	public
Trusted Host	If you enter a trusted host, your Prestige will only respond to SNMP messages from this address. A blank (default) field means your Prestige will respond to all SNMP messages it receives, regardless of source.	0.0.0.0
Trap:		
Community	Type the trap community, which is the password sent with each trap to the SNMP manager.	public
Destination	Type the IP address of the station to send your SNMP traps to.	0.0.0.0
When you have completed this menu, press [ENTER] at the prompt "Press ENTER to confirm or ESC to cancel" to save your configuration or press [ESC] to cancel and go back to the previous screen.		

## 21.4 SNMP Traps

The Prestige will send traps to the SNMP manager when any one of the following events occurs:

**Table 21-2 SNMP Traps**

TRAP #	TRAP NAME	DESCRIPTION
1	coldStart ( <i>defined in RFC-1215</i> )	A trap is sent after booting (power on).
2	warmStart ( <i>defined in RFC-1215</i> )	A trap is sent after booting (software reboot).
3	linkDown ( <i>defined in RFC-1215</i> )	A trap is sent when the port is down.
4	linkUp ( <i>defined in RFC-1215</i> )	A trap is sent when the port is up.
5	authenticationFailure ( <i>defined in RFC-1215</i> )	A trap is sent to the manager when receiving any SNMP get or set requirements with wrong community (password).
6	whyReboot (defined in ZYXEL-MIB)	A trap is sent with the reason of restart before rebooting when the system is going to restart (warm start).
6a	For intentional reboot :	A trap is sent with the message "System reboot by user!" if reboot is done intentionally, (for example, download new files, CLI command "sys reboot", etc.).

The following table maps the physical port and encapsulation to the interface type.

**Table 21-3 Ports and Interface Types**

PHYSICAL PORT/ENCAP	INTERFACE TYPE
LAN port(s)	enet0
Wireless port	enet1
PPPoE encap	pppoe
1483 encap	mppoa
Ethernet encap	enet-encap
PPPoA	ppp



# Chapter 22

## System Information and Diagnosis

*This chapter covers the information and diagnostic tools in SMT menus 24.1 to 24.4 and menu 24.8.*

### 22.1 System Maintenance Overview

These tools include updates on system status, port status, log and trace capabilities and upgrades for the system software. This chapter describes how to use these tools in detail.

Type 24 in the main menu to open **Menu 24 – System Maintenance**, as shown in the following figure.

```
Menu 24 - System Maintenance

1. System Status
2. System Information and Console Port Speed
3. Log and Trace
4. Diagnostic
5. Backup Configuration
6. Restore Configuration
7. Upload Firmware
8. Command Interpreter Mode
9. Call Control
10. Time and Date Setting
11. Remote Management

Enter Menu Selection Number:
```

**Figure 22-1 Menu 24 System Maintenance**

### 22.2 System Status

The first selection, System Status gives you information on the status and statistics of the ports, as shown next. System Status is a tool that can be used to monitor your Prestige. Specifically, it gives you information on your ADSL telephone line status, number of packets sent and received.

To get to System Status, type 24 to go to **Menu 24 — System Maintenance**. From this menu, type 1. **System Status**. There are two commands in **Menu 24.1 — System Maintenance — Status**. Entering 1 resets the counters; pressing [TAB] toggles between Ethernet and USB port status display and [ESC] takes you back to the previous screen.

The following table describes the fields present in **Menu 24.1 — System Maintenance — Status** which are read-only and meant for diagnostic purposes.

```

Menu 24.1 - System Maintenance - Status                                07:05:39
                                                                    Sat. Jan. 01, 2000

Node-Lnk Status      TxPkts      RxPkts      Errors  Tx B/s  Rx B/s      Up Time
1-PPPoE Idle         0           0           0       0       0          0:00:00
2          N/A         0           0           0       0       0          0:00:00
3          N/A         0           0           0       0       0          0:00:00
4          N/A         0           0           0       0       0          0:00:00
5          N/A         0           0           0       0       0          0:00:00
6          N/A         0           0           0       0       0          0:00:00
7          N/A         0           0           0       0       0          0:00:00
8          N/A         0           0           0       0       0          0:00:00

My WAN IP (from ISP): 0.0.0.0

Ethernet:                                                              WAN:
  Status: 100M/Full Duplex Tx Pkts: 2074      Line Status: Down
  Collisions: 0              Rx Pkts: 2665      Upstream Speed: 0 kbps
  CPU Load = 16.44%          Downstream Speed: 0 kbps

                                Press Command:
                                COMMANDS: 1-Reset Counters  TAB-Next Page  ESC-Exit
    
```

**Figure 22-2 Menu 24.1 System Maintenance : Status**

The following table describes the fields present in **Menu 24.1 — System Maintenance — Status**.

**Table 22-1 Menu 24.1 System Maintenance : Status**

FIELD	DESCRIPTION
Node-Lnk	This is the node index number and link type. Link types are: PPP, ENET, 1483.
Status	This shows the status of the remote node.
TxPkts	The number of transmitted packets to this remote node.
RxPkts	The number of received packets from this remote node.
Errors	The number of error packets on this connection.
Tx B/s	This shows the transmission rate in bytes per second.
Rx B/s	This shows the receiving rate in bytes per second.
Up Time	This is the time this channel has been connected to the current remote node.
My WAN IP (from ISP)	This is the IP address of the ISP remote node.
Ethernet	This is the Ethernet or USB port. Press [TAB] to toggle between Ethernet and USB port status display.

**Table 22-1 Menu 24.1 System Maintenance : Status**

FIELD	DESCRIPTION
Status	This shows the current status of the LAN.
Tx Pkts	This is the number of transmitted packets to the LAN.
Rx Pkts	This is the number of received packets from the LAN.
Collision	This is the number of collisions.
WAN	This shows statistics for the WAN.
Line Status	This shows the current status of the xDSL line which can be <b>Up</b> or <b>Down</b> .
Upstream Speed	This shows the upstream transfer rate in kbps.
Downstream Speed	This shows the downstream transfer rate in kbps.
CPU Load	This specifies the percentage of CPU utilization.

## 22.3 System Information

To get to the System Information :

- Step 1.** Enter 24 in the main menu to display **Menu 24 — System Maintenance**.
- Step 2.** Enter 2 to display **Menu 24.2 — System Information**.
- Step 3.** From this menu you have two choices as shown in the next figure:

```

Menu 24.2 - System Information and Console Port Speed
  1. System Information
  2. Console Port Speed

Please enter selection:

```

**Figure 22-3 Menu 24.2 System Information and Console Port Speed**

### 22.3.1 System Information

Enter 1 in menu 24.2 to display the screen shown next.

```

Menu 24.2.1 - System Maintenance - Information

Name: p623r-t1
Routing: IP/BRIDGE
ZyNOS F/W Version: V3.40(00.1)b1 | 11/3/2003
ADSL Chipset Vendor: TrendChip, Version 0.2.15. ASIC 1.1 +
Standard: Multi-Mode

LAN
Ethernet Address: 00:a0:c5:5b:ce:2e
IP Address: 192.168.1.1
IP Mask: 255.255.255.0
DHCP: Server

Press ESC or RETURN to Exit:
    
```

**Figure 22-4 Menu 24.2.1 System Maintenance : Information**

The following table describes the fields in this menu.

**Table 22-2 Menu 24.2.1 System Maintenance : Information**

FIELD	DESCRIPTION
Name	This displays the system name of your Prestige. This information can be changed in <b>Menu 1 – General Setup</b> .
Routing	This refers to the routing protocol used.
ZyNOS F/W Version	This refers to the ZyNOS (ZyXEL Network Operating System) system firmware version. ZyNOS is a registered trademark of ZyXEL Communications Corporation.
ADSL Chipset Vendor	This displays the vendor of the ADSL chipset and DSL version.
Standard	This refers to the operational protocol the Prestige and the DSLAM (Digital Subscriber Line Access Multiplexer) are using.
LAN	
Ethernet Address	This refers to the Ethernet MAC (Media Access Control) of your Prestige.
IP Address	This is the IP address of the Prestige in dotted decimal notation.
IP Mask	This shows the subnet mask of the Prestige.
DHCP	This field shows the DHCP setting (None, Relay or Server) of the Prestige.

## 22.3.2 Console Port Speed

**The Prestige has an internal console port for support personnel only. Do not open the Prestige as it will void your warranty.**

You can set up different port speeds for the console port through **Menu 24.2.2 – System Maintenance – Console Port Speed**. Your Prestige supports 9600 (default), 19200, 38400, 57600 and 115200 bps. Press [SPACE BAR] and then [ENTER] to select the desired speed in menu 24.2.2, as shown in the following figure.

```
Menu 24.2.2 - System Maintenance - Change Console Port Speed

Console Port Speed: 9600

Press ENTER to Confirm or ESC to Cancel:
```

**Figure 22-5 Menu 24.2.2 System Maintenance : Change Console Port Speed**

**Once you change the Prestige console port speed, you must also set the speed parameter for the communication software you are using to connect to the Prestige.**

## 22.4 Log and Trace

There are two logging facilities in the Prestige. The first is the error logs and trace records that are stored locally. The second is the UNIX syslog facility for message logging.

### 22.4.1 Viewing Error Log

The first place you should look for clues when something goes wrong is the error log. Follow the procedures to view the local error/trace log:

- Step 1.** Type 24 in the main menu to display **Menu 24 – System Maintenance**.
- Step 2.** From menu 24, type 3 to display **Menu 24.3 – System Maintenance – Log and Trace**.

```
Menu 24.3 - System Maintenance - Log and Trace

1. View Error Log
2. UNIX Syslog

Please enter selection:
```

**Figure 22-6 Menu 24.3 System Maintenance : Log and Trace**

**Step 3.** Enter 1 from **Menu 24.3 — System Maintenance — Log and Trace** to display the error log in the system.

After the Prestige finishes displaying the error log, you will have the option to clear it. Samples of typical error and information messages are presented in the next figure.

```

59 Thu Jan 01 00:00:03 1970 PP0f INFO LAN promiscuous mode <0>
60 Thu Jan 01 00:00:03 1970 PP00 -WARN SNMP TRAP 0: cold start
61 Thu Jan 01 00:00:03 1970 PP00 INFO main: init completed
62 Thu Jan 01 00:00:19 1970 PP00 INFO SMT Session Begin
63 Thu Jan 01 00:00:24 1970 PP0a WARN MPOA Link Down
Clear Error Log (y/n):
    
```

**Figure 22-7 Sample Error and Information Messages**

### 22.4.2 Syslog and Accounting

The Prestige uses the UNIX syslog facility to log the CDR (Call Detail Record) and system messages to a syslog server. Syslog and accounting can be configured in **Menu 24.3.2 — System Maintenance — UNIX Syslog**, as shown next.

```

Menu 24.3.2 - System Maintenance - UNIX Syslog

UNIX Syslog:
Active= No
Syslog IP Address= 0.0.0.0
Log Facility= Local 1

Types:
CDR= No
Packet Triggered= No
Filter Log= No
PPP Log= No

Press ENTER to Confirm or ESC to Cancel:
    
```

**Figure 22-8 Menu 24.3.2 System Maintenance : UNIX Syslog**

You need to configure the UNIX syslog parameters described in the following table to activate syslog then choose what you want to log.

**Table 22-3 Menu 24.3.2 System Maintenance : UNIX Syslog**

PARAMETER	DESCRIPTION
UNIX Syslog:	
Active	Use [SPACE BAR] and then [ENTER] to turn syslog on or off.
Syslog IP Address	Type the IP address of your syslog server.

**Table 22-3 Menu 24.3.2 System Maintenance : UNIX Syslog**

PARAMETER	DESCRIPTION
Log Facility	Use [SPACE BAR] and then [ENTER] to select one of seven different local options. The log facility lets you log the message in different server files. Refer to your UNIX manual.
Types:	
CDR	Call Detail Record (CDR) logs all data phone line activity if set to <b>Yes</b> .
Packet triggered	The first 48 bytes or octets and protocol type of the triggering packet is sent to the UNIX syslog server when this field is set to <b>Yes</b> .
Filter log	No filters are logged when this field is set to <b>No</b> . Filters with the individual filter <b>Log Filter</b> field set to <b>Yes</b> are logged when this field is set to <b>Yes</b> .
PPP log	PPP events are logged when this field is set to <b>Yes</b> .

Your Prestige sends four types of syslog messages. Some examples of these syslog messages with their message formats are shown next:

### 1. CDR

CDR Message Format
<pre> sdcmdSyslogSend( SYSLOG_CDR, SYSLOG_INFO, String ); String = board xx line xx channel xx, call xx, str board = the hardware board ID line = the WAN ID in a board Channel = channel ID within the WAN call = the call reference number which starts from 1 and increments by 1 for each new call str = C01 Outgoing Call dev xx ch xx (dev:device No. ch:channel No.)       L02 Tunnel Connected(L2TP)       C02 OutCall Connected xxxx (means connected speed) xxxxx (means Remote Call Number)       L02 Call Terminated       C02 Call Terminated </pre>

```
Jul 19 11:19:27 192.168.102.2 ZyXEL Communications Corp.: board 0 line 0 channel 0, call
1, C01 Outgoing Call dev=2 ch=0 40002
```

```
Jul 19 11:19:32 192.168.102.2 ZyXEL Communications Corp.: board 0 line 0 channel 0, call
1, C02 OutCall Connected 64000 40002
```

```
Jul 19 11:20:06 192.168.102.2 ZyXEL Communications Corp.: board 0 line 0 channel 0, call
1, C02 Call Terminated
```

### 2. Packet triggered

Packet triggered Message Format
<pre> sdcmdSyslogSend( SYSLOG_PKTTRI, SYSLOG_NOTICE, String ); String = Packet trigger: Protocol=xx Data=xxxxxxxxxxxx...x Protocol: (1:IP 2:BPDU 3:ATALK 4:IPNG) Data: We will send forty-eight Hex characters to the server </pre>

```
Jul 19 11:28:39 192.168.102.2 ZyXEL Communications Corp.: Packet Trigger: Protocol=1,
Data=4500003c100100001f010004c0a86614ca849a7b08004a5c020001006162636465666768696a6b6c6d6e6
f7071727374
```

```
Jul 19 11:28:56 192.168.102.2 ZyXEL Communications Corp.: Packet Trigger: Protocol=1,
Data=4500002c1b0140001f06b50ec0a86614ca849a7b0427001700195b3e00000000600220008cd4000002040
5b4
```

```
Jul 19 11:29:06 192.168.102.2 ZyXEL Communications Corp.: Packet Trigger: Protocol=1,
Data=45000028240140001f06ac12c0a86614ca849a7b0427001700195b451d1430135004000077600000
```

### 3. Filter log

<b>Filter log Message Format</b>
<pre>sdcmdSyslogSend(SYSLOG_FILLOG, SYSLOG_NOTICE, String ); String = IP[Src=xx.xx.xx.xx Dst=xx.xx.xx.xx prot spo=xxxx dpo=xxxx] S04&gt;R01mD  IP[...] is the packet header and S04&gt;R01mD means filter set 4 (S) and rule 1 (R), match (m) drop (D).  Src: Source Address Dst: Destination Address prot: Protocol ("TCP", "UDP", "ICMP") spo: Source port dpo: Destination port</pre>

```
Jul 19 14:43:55 192.168.102.2 ZyXEL Communications Corp.: IP[Src=202.132.154.123
Dst=255.255.255.255 UDP spo=0208 dpo=0208]}S03>R01mF
```

```
Jul 19 14:44:00 192.168.102.2 ZyXEL Communications Corp.: IP[Src=192.168.102.20
Dst=202.132.154.1 UDP spo=05d4 dpo=0035]}S03>R01mF
```

```
Jul 19 14:44:04 192.168.102.2 ZyXEL Communications Corp.: IP[Src=192.168.102.20
Dst=202.132.154.1 UDP spo=05d4 dpo=0035]}S03>R01mF
```

### 4. PPP log

<b>PPP Log Message Format</b>
<pre>sdcmdSyslogSend( SYSLOG_PPPLOG, SYSLOG_NOTICE, String ); String = ppp:Proto Starting / ppp:Proto Opening / ppp:Proto Closing / ppp:Proto Shutdown Proto = LCP / ATCP / BACP / BCP / CBCP / CCP / CHAP/ PAP / IPCP /</pre>

```
Jul 19 11:42:44 192.168.102.2 ZyXEL Communications Corp.: ppp:LCP Closing
```

```
Jul 19 11:42:49 192.168.102.2 ZyXEL Communications Corp.: ppp:IPCP Closing
```

```
Jul 19 11:42:54 192.168.102.2 ZyXEL Communications Corp.: ppp:CCP Closing
```

## 22.5 Diagnostic

The diagnostic facility allows you to test the different aspects of your Prestige to determine if it is working properly. Menu 24.4 allows you to choose among various types of diagnostic tests to evaluate your system, as shown in the following figure.



Follow the procedure next to get to Diagnostic:

**Step 1.** From the main menu, type 24 to open **Menu 24 – System Maintenance**.

**Step 2.** From this menu, type 4. Diagnostic to open **Menu 24.4 – System Maintenance – Diagnostic**.

```

Menu 24.4 - System Maintenance - Diagnostic

xDSL                               System
1.  Reset xDSL                     21. Reboot System
                                     22. Command Mode

TCP/IP
12. Ping Host

Enter Menu Selection Number:
Host IP Address= N/A

```

**Figure 22-9 Menu 24.4 System Maintenance : Diagnostic**

The following table describes the diagnostic tests available in menu 24.4 for and the connections.

**Table 22-4 Menu 24.4 System Maintenance Menu : Diagnostic**

FIELD	DESCRIPTION
Reset xDSL	Re-initialize the xDSL link to the telephone company.
Ping Host	Ping the host to see if the links and TCP/IP protocol on both systems are working.
Reboot System	Reboot the Prestige.
Command Mode	Type the mode to test and diagnose your Prestige using specified commands.
Host IP Address	If you typed 12 to Ping Host, now type the address of the computer you want to ping.



# Chapter 23

## Firmware and Configuration File Maintenance

*This chapter tells you how to backup and restore your configuration file as well as upload new firmware and configuration files.*

### 23.1 Filename Conventions

The configuration file (often called the romfile or rom-0) contains the factory default settings in the menus such as password, DHCP Setup, TCP/IP Setup, etc. It arrives from ZyXEL with a “rom” filename extension. Once you have customized the Prestige's settings, they can be saved back to your computer under a filename of your choosing.

ZyNOS (ZyXEL Network Operating System sometimes referred to as the “ras” file) is the system firmware and has a “bin” filename extension. With many FTP and TFTP clients, the filenames are similar to those seen next.

**Only use firmware for your Prestige's specific model. Refer to the label on the bottom of your Prestige.**

```
ftp> put firmware.bin ras
```

This is a sample FTP session showing the transfer of the computer file " firmware.bin" to the Prestige.

```
ftp> get rom-0 config.cfg
```

This is a sample FTP session saving the current configuration to the computer file “config.cfg”.

If your (T)FTP client does not allow you to have a destination filename different than the source, you will need to rename them as the Prestige only recognizes “rom-0” and “ras”. Be sure you keep unaltered copies of both files for later use.

The following table is a summary. Please note that the internal filename refers to the filename on the Prestige and the external filename refers to the filename not on the Prestige, that is, on your computer, local network or FTP site and so the name (but not the extension) may vary. After uploading new firmware, see the **ZyNOS F/W Version** field in **Menu 24.2.1 – System Maintenance – Information** to confirm that you have uploaded the correct firmware version. The AT command is the command you enter after you press “y” when prompted in the SMT menu to go into debug mode.

**Table 23-1 Filename Conventions**

FILE TYPE	INTERNAL NAME	EXTERNAL NAME	DESCRIPTION
Configuration File	Rom-0	This is the configuration filename on the Prestige. Uploading the rom-0 file replaces the entire ROM file system, including your Prestige configurations, system-related data (including the default password), the error log and the trace log.	*.rom
Firmware	Ras	This is the generic name for the ZyNOS firmware on the Prestige.	*.bin

## 23.2 Backup Configuration

**The Prestige displays different messages explaining different ways to backup, restore and upload files in menus 24.5, 24.6, 24.7.1 and 24.7.2; depending on whether you use the console port or Telnet.**

Option 5 from **Menu 24 – System Maintenance** allows you to backup the current Prestige configuration to your computer. Backup is highly recommended once your Prestige is functioning properly. FTP is the preferred methods for backing up your current configuration to your computer since they are faster.

Please note that terms “download” and “upload” are relative to the computer. Download means to transfer from the Prestige to the computer, while upload means from your computer to the Prestige.

## 23.2.1 Backup Configuration

Follow the instructions as shown in the next screen.

```
Menu 24.5 - Backup Configuration

To transfer the configuration file to your computer, follow the procedure
below:

1. Launch the FTP client on your computer.
2. Type "open" and the IP address of your system. Then type "root" and
   SMT password as requested.
3. Locate the 'rom-0' file.
4. Type 'get rom-0' to back up the current system configuration to your
   computer.

For details on FTP commands, please consult the documentation of your FTP
client program. For details on backup using TFTP (note that you must remain
in this menu to back up using TFTP), please see your user manual.

Press ENTER to Exit:
```

**Figure 23-1 Telnet in Menu 24.5**

## 23.2.2 Using the FTP Command from the Command Line

- Step 1.** Launch the FTP client on your computer.
- Step 2.** Enter “open”, followed by a space and the IP address of your Prestige.
- Step 3.** Press [ENTER] when prompted for a username.
- Step 4.** Enter your password as requested (the default is “1234”).
- Step 5.** Enter “bin” to set transfer mode to binary.
- Step 6.** Use “get” to transfer files from the Prestige to the computer, for example, “get rom-0 config.rom” transfers the configuration file on the Prestige to your computer and renames it “config.rom”. See earlier in this chapter for more information on filename conventions.
- Step 7.** Enter “quit” to exit the ftp prompt.

## 23.2.3 Example of FTP Commands from the Command Line

```

331 Enter PASS command
Password:
230 Logged in
ftp> bin
200 Type I OK
ftp> get rom-0 zyxel.rom
200 Port command okay
150 Opening data connection for STOR ras
226 File received OK
ftp: 16384 bytes sent in 1.10Seconds 297.89Kbytes/sec.
ftp> quit
    
```

**Figure 23-2 FTP Session Example**

### 23.2.4 GUI-based FTP Clients

The following table describes some of the commands that you may see in GUI-based FTP clients.

**Table 23-2 General Commands for GUI-based FTP Clients**

COMMAND	DESCRIPTION
Host Address	Enter the address of the host server.
Login Type	<p>Anonymous.</p> <p>This is when a user I.D. and password is automatically supplied to the server for anonymous access. Anonymous logins will work only if your ISP or service administrator has enabled this option.</p> <p>Normal.</p> <p>The server requires a unique User ID and Password to login.</p>
Transfer Type	<p>You must use binary mode when uploading the configuration or firmware file.</p> <p>Transfer files in either ASCII (plain text format) or in binary mode.</p>
Initial Remote Directory	Specify the default remote directory (path).
Initial Local Directory	Specify the default local directory (path).

### 23.2.5 TFTP and FTP over WAN Will Not Work When

TFTP, FTP and Telnet over WAN will not work when:

1. You have applied a filter in menu 3.1 (LAN) or in menu 11.5 (WAN) to block Telnet service.
2. You have an SMT console session running.

## 23.2.6 Backup Configuration Using TFTP

The Prestige supports the up/downloading of the firmware and the configuration file using TFTP (Trivial File Transfer Protocol) over LAN. Although TFTP should work over WAN as well, it is not recommended.

To use TFTP, your computer must have both telnet and TFTP clients. To backup the configuration file, follow the procedure shown next.

- Step 1.** Use telnet from your computer to connect to the Prestige and log in. Because TFTP does not have any security checks, the Prestige records the IP address of the telnet client and accepts TFTP requests only from this address.
- Step 2.** Put the SMT in command interpreter (CI) mode by entering 8 in **Menu 24 – System Maintenance**.
- Step 3.** Enter command “sys stdio 0” to disable the SMT timeout, so the TFTP transfer will not be interrupted. Enter command “sys stdio 5” to restore the five-minute SMT timeout (default) when the file transfer is complete.
- Step 4.** Launch the TFTP client on your computer and connect to the Prestige. Set the transfer mode to binary before starting data transfer.
- Step 5.** Use the TFTP client (see the example below) to transfer files between the Prestige and the computer. The file name for the configuration file is “rom-0” (rom-zero, not capital o).

Note that the telnet connection must be active and the SMT in CI mode before and during the TFTP transfer. For details on TFTP commands (see following example), please consult the documentation of your TFTP client program. For UNIX, use “get” to transfer from the Prestige to the computer and “binary” to set binary transfer mode.

## 23.2.7 TFTP Command Example

The following is an example TFTP command:

```
tftp [-i] host get rom-0 config.rom
```

where “i” specifies binary image transfer mode (use this mode when transferring binary files), “host” is the Prestige IP address, “get” transfers the file source on the Prestige (rom-0, name of the configuration file on the Prestige) to the file destination on the computer and renames it config.rom.

## 23.2.8 GUI-based TFTP Clients

The following table describes some of the fields that you may see in GUI-based TFTP clients.

**Table 23-3 General Commands for GUI-based TFTP Clients**

COMMAND	DESCRIPTION
Host	Enter the IP address of the Prestige. 192.168.1.1 is the Prestige's default IP address when shipped.
Send/Fetch	Use "Send" to upload the file to the Prestige and "Fetch" to back up the file on your computer.
Local File	Enter the path and name of the firmware file (*.bin extension) or configuration file (*.rom extension) on your computer.
Remote File	This is the filename on the Prestige. The filename for the firmware is "ras" and for the configuration file, is "rom-0".
Binary	Transfer the file in binary mode.
Abort	Stop transfer of the file.

Refer to *section 23.2.5* to read about configurations that disallow TFTP and FTP over WAN.

## 23.3 Restore Configuration

This section shows you how to restore a previously saved configuration. Note that this function erases the current configuration before restoring a previous back up configuration; please do not attempt to restore unless you have a backup configuration file stored on disk.

FTP is the preferred method for restoring your current computer configuration to your Prestige since FTP is faster. Please note that you must wait for the system to automatically restart after the file transfer is complete.

**WARNING!**  
**DO NOT INTERRUPT THE FILE TRANSFER PROCESS AS THIS MAY  
PERMANENTLY DAMAGE YOUR PRESTIGE.**

### 23.3.1 Restore Using FTP



For details about backup using (T)FTP please refer to earlier sections on FTP and TFTP file upload in this chapter.

```
Menu 24.6 - Restore Configuration

To transfer the firmware and the configuration file, follow the procedure
below:

1. Launch the FTP client on your computer.
2. Type "open" and the IP address of your system. Then type "root" and
   SMT password as requested.
3. Type "put backupfilename rom-0" where backupfilename is the name of
   your backup configuration file on your computer and rom-0 is the
   remote file name on the system. This restores the configuration to
   your system.
4. The system reboots automatically after a successful file transfer.

For details on FTP commands, please consult the documentation of your FTP
client program. For details on restoring using TFTP (note that you must
remain on this menu to restore using TFTP), please see your user manual.

Press ENTER to Exit:
```

**Figure 23-3 Telnet into Menu 24.6**

- Step 1.** Launch the FTP client on your computer.
- Step 2.** Enter “open”, followed by a space and the IP address of your Prestige.
- Step 3.** Press [ENTER] when prompted for a username.
- Step 4.** Enter your password as requested (the default is “1234”).
- Step 5.** Enter “bin” to set transfer mode to binary.
- Step 6.** Find the “rom” file (on your computer) that you want to restore to your Prestige.
- Step 7.** Use “put” to transfer files from the Prestige to the computer, for example, “put config.rom rom-0” transfers the configuration file “config.rom” on your computer to the Prestige. See earlier in this chapter for more information on filename conventions.
- Step 8.** Enter “quit” to exit the ftp prompt. The Prestige will automatically restart after a successful restore process.

## 23.3.2 Restore Using FTP Session Example

```
ftp> put config.rom rom-0
200 Port command okay
150 Opening data connection for STOR rom-0
226 File received OK
221 Goodbye for writing flash
ftp: 16384 bytes sent in 0.06Seconds 273.07Kbytes/sec.
ftp>quit
```

**Figure 23-4 Restore Using FTP Session Example**

Refer to *section 23.2.5* to read about configurations that disallow TFTP and FTP over WAN.

## 23.4 Uploading Firmware and Configuration Files

This section shows you how to upload firmware and configuration files. You can upload configuration files by following the procedure in the previous *Restore Configuration* section or by following the instructions in **Menu 24.7.2 – System Maintenance – Upload System Configuration File** (for console port).

**WARNING!**  
**DO NOT INTERRUPT THE FILE TRANSFER PROCESS AS THIS MAY PERMANENTLY DAMAGE YOUR PRESTIGE.**

### 23.4.1 Firmware File Upload

FTP is the preferred method for uploading the firmware and configuration. To use this feature, your computer must have an FTP client.

When you telnet into the Prestige, you will see the following screens for uploading firmware and the configuration file using FTP.

```
Menu 24.7.1 - System Maintenance - Upload System Firmware

To upload the system firmware, follow the procedure below:

1. Launch the FTP client on your workstation.
2. Type "open" and the IP address of your system. Then type "root" and
   SMT password as requested.
3. Type "put firmwarefilename ras" where "firmwarefilename" is the name
   of your firmware upgrade file on your workstation and "ras" is the
   remote file name on the system.
4. The system reboots automatically after a successful firmware upload.

For details on FTP commands, please consult the documentation of your FTP
client program. For details on uploading system firmware using TFTP (note
that you must remain on this menu to upload system firmware using TFTP),
please see your manual.

Press ENTER to Exit:
```

**Figure 23-5 Telnet Into Menu 24.7.1 Upload System Firmware**

## 23.4.2 Configuration File Upload

You see the following screen when you telnet into menu 24.7.2.

```
Menu 24.7.2 - System Maintenance - Upload System Configuration File

To upload the system configuration file, follow the procedure below:

1. Launch the FTP client on your workstation.
2. Type "open" and the IP address of your system. Then type "root" and
   SMT password as requested.
3. Type "put configurationfilename rom-0" where "configurationfilename"
   is the name of your system configuration file on your workstation, which
   will be transferred to the "rom-0" file on the system.
4. The system reboots automatically after the upload system configuration
   file process is complete.

For details on FTP commands, please consult the documentation of your FTP
client program. For details on uploading system firmware using TFTP (note
that you must remain on this menu to upload system firmware using TFTP),
please see your manual.

Press ENTER to Exit:
```

**Figure 23-6 Telnet Into Menu 24.7.2 System Maintenance**

To upload the firmware and the configuration file, follow these examples

## 23.4.3 FTP File Upload Command from the DOS Prompt Example

**Step 1.** Launch the FTP client on your computer.

- Step 2.** Enter “open”, followed by a space and the IP address of your Prestige.
- Step 3.** Press [ENTER] when prompted for a username.
- Step 4.** Enter your password as requested (the default is “1234”).
- Step 5.** Enter “bin” to set transfer mode to binary.
- Step 6.** Use “put” to transfer files from the computer to the Prestige, for example, “put firmware.bin ras” transfers the firmware on your computer (firmware.bin) to the Prestige and renames it “ras”. Similarly, “put config.rom rom-0” transfers the configuration file on your computer (config.rom) to the Prestige and renames it “rom-0”. Likewise “get rom-0 config.rom” transfers the configuration file on the Prestige to your computer and renames it “config.rom.” See earlier in this chapter for more information on filename conventions.
- Step 7.** Enter “quit” to exit the ftp prompt.

**The Prestige automatically restarts after a successful file upload.**

### 23.4.4 FTP Session Example of Firmware File Upload

```
331 Enter PASS command
Password:
230 Logged in
ftp> bin
200 Type I OK
ftp> put firmware.bin ras
200 Port command okay
150 Opening data connection for STOR ras
226 File received OK
ftp: 1103936 bytes sent in 1.10Seconds 297.89Kbytes/sec.
ftp> quit
```

**Figure 23-7 FTP Session Example of Firmware File Upload**

More commands (found in GUI-based FTP clients) are listed earlier in this chapter.

Refer to *section 23.2.5* to read about configurations that disallow TFTP and FTP over WAN.

### 23.4.5 TFTP File Upload

The Prestige also supports the uploading of firmware files using TFTP (Trivial File Transfer Protocol) over LAN. Although TFTP should work over WAN as well, it is not recommended.

To use TFTP, your computer must have both telnet and TFTP clients. To transfer the firmware and the configuration file, follow the procedure shown next.

- Step 1.** Use telnet from your computer to connect to the Prestige and log in. Because TFTP does not have any security checks, the Prestige records the IP address of the telnet client and accepts TFTP requests only from this address.
- Step 2.** Put the SMT in command interpreter (CI) mode by entering 8 in **Menu 24 – System Maintenance**.
- Step 3.** Enter the command “sys stdio 0” to disable the console timeout, so the TFTP transfer will not be interrupted. Enter “command sys stdio 5” to restore the five-minute console timeout (default) when the file transfer is complete.
- Step 4.** Launch the TFTP client on your computer and connect to the Prestige. Set the transfer mode to binary before starting data transfer.
- Step 5.** Use the TFTP client (see the example below) to transfer files between the Prestige and the computer. The file name for the firmware is “ras”.

Note that the telnet connection must be active and the Prestige in CI mode before and during the TFTP transfer. For details on TFTP commands (see following example), please consult the documentation of your TFTP client program. For UNIX, use “get” to transfer from the Prestige to the computer, “put” the other way around, and “binary” to set binary transfer mode.

### 23.4.6 TFTP Upload Command Example

The following is an example TFTP command:

```
tftp [-i] host put firmware.bin ras
```

where “i” specifies binary image transfer mode (use this mode when transferring binary files), “host” is the Prestige’s IP address and “put” transfers the file source on the computer (firmware.bin – name of the firmware on the computer) to the file destination on the remote host (ras - name of the firmware on the Prestige).

Commands that you may see in GUI-based TFTP clients are listed earlier in this chapter.



# Chapter 24

## System Maintenance

*This chapter leads you through SMT menus 24.8 to 24.10.*

### 24.1 Command Interpreter Mode Overview

The Command Interpreter (CI) is a part of the main system firmware. The CI provides much of the same functionality as the SMT, while adding some low-level setup and diagnostic functions. Enter the CI from the SMT by selecting menu 24.8. See the included disk or the [zyxel.com](http://zyxel.com) web site for more detailed information on CI commands. Enter 8 from **Menu 24 — System Maintenance**. A list of valid commands can be found by typing `help` or `?` at the command prompt. Type “exit” to return to the SMT main menu when finished.

```
Menu 24 - System Maintenance

1. System Status
2. System Information and Console Port Speed
3. Log and Trace
4. Diagnostic
5. Backup Configuration
6. Restore Configuration
7. Upload Firmware
8. Command Interpreter Mode
9. Call Control
10. Time and Date Setting
11. Remote Management

Enter Menu Selection Number:
```

**Figure 24-1 Command Mode in Menu 24**

```
Copyright (c) 1994 - 2003 ZyXEL Communications Corp.
p623r-t1> ?
Valid commands are:
sys          exit          ether          wan
etherdbg    usb            ip            bridge
p623r-t1>
```

**Figure 24-2 Valid Commands**

## 24.2 Call Control Support

Call Control Support is only applicable when **Encapsulation** is set to **PPPoE** in menu 4 or menu 11.1.

The budget management function allows you to set a limit on the total outgoing call time of the Prestige within certain times. When the total outgoing call time exceeds the limit, the current call will be dropped and any future outgoing calls will be blocked.

To access the call control menu, select option 9 in menu 24 to go to **Menu 24.9 — System Maintenance — Call Control**, as shown in the next table.

```

Menu 24.9 - System Maintenance - Call Control

1. Budget Management

Enter Menu Selection Number:
    
```

**Figure 24-3 Menu 24.9 System Maintenance : Call Control**

### 24.2.1 Budget Management

Menu 24.9.1 shows the budget management statistics for outgoing calls. Enter 1 from **Menu 24.9 — System Maintenance — Call Control** to bring up the following menu.

```

Menu 24.9.1 - Budget Management

Remote Node      Connection Time/Total Budget      Elapsed Time/Total Period
1. MyISP         No Budget                          No Budget
2.-----
3.-----
4.-----
5.-----
6.-----
7.-----
8.-----

Reset Node (0 to update screen):
    
```

**Figure 24-4 Menu 24.9.1 Budget Management**



The total budget is the time limit on the accumulated time for outgoing calls to a remote node. When this limit is reached, the call will be dropped and further outgoing calls to that remote node will be blocked. After each period, the total budget is reset. The default for the total budget is 0 minutes and the period is 0 hours, meaning no budget control. You can reset the accumulated connection time in this menu by entering the index of a remote node. Enter 0 to update the screen. The budget and the reset period can be configured in menu 11.1 for the remote node when PPPoE encapsulation is selected.

**Table 24-1 Menu 24.9.1 Budget Management**

FIELD	DESCRIPTION	EXAMPLE
Remote Node	Enter the index number of the remote node you want to reset (just one in this case)	1
Connection Time/Total Budget	This is the total connection time that has gone by (within the allocated budget that you set in menu 11.1.	5/10 means that 5 minutes out of a total allocation of 10 minutes have lapsed.
Elapsed Time/Total Period	The period is the time cycle in hours that the allocation budget is reset (see menu 11.1.) The elapsed time is the time used up within this period.	0.5/1 means that 30 minutes out of the 1 hour time period has lapsed.
Enter "0" to update the screen or press [ESC] to return to the previous screen.		

## 24.3 Time and Date Setting

The Prestige keeps track of the time and date. There is also a software mechanism to set the time manually or get the current time and date from an external server when you turn on your Prestige. Menu 24.10 allows you to update the time and date settings of your Prestige. The real time is then displayed in the Prestige error logs.

Select menu 24 in the main menu to open **Menu 24 System Maintenance**, as shown next.

```
Menu 24 - System Maintenance

1. System Status
2. System Information
3. Log and Trace
4. Diagnostic
5. Backup Configuration
6. Restore Configuration
7. Upload Firmware
8. Command Interpreter Mode
9. Call Control
10. Time and Date Setting
11. Remote Management

Enter Menu Selection Number:
```

**Figure 24-5 Menu 24 System Maintenance**

Then enter 10 to go to **Menu 24.10 System Maintenance Time and Date Setting** to update the time and date settings of your Prestige as shown in the following screen.

```
Menu 24.10 - System Maintenance - Time and Date Setting

Use Time Server when Bootup= None
Time Server Address= N/A

Current Time:                               00 : 00 : 00
New Time (hh:mm:ss):                       11 : 23 : 16

Current Date:                               2000 - 01 - 01
New Date (yyyy-mm-dd):                     2001 - 03 - 01

Time Zone= GMT

Daylight Saving= No
Start Date (mm-dd):                         01 - 00
End Date (mm_dd):                           01 - 00

Press ENTER to Confirm or ESC to Cancel:
```

**Figure 24-6 Menu 24.10 System Maintenance: Time and Date Setting**

**Table 24-2 Menu 24.10 System Maintenance: Time and Date Setting**

FIELD	DESCRIPTION
Use Time Server when Bootup	<p>Enter the time service protocol that your time server sends when you turn on the Prestige. Not all time servers support all protocols, so you may have to check with your ISP/network administrator or use trial and error to find a protocol that works. The main differences between them are the format.</p> <p><b>Daytime (RFC 867)</b> format is day/month/year/time zone of the server.</p> <p><b>Time (RFC-868)</b> format displays a 4-byte integer giving the total number of seconds since 1970/1/1 at 0:0:0.</p> <p><b>NTP (RFC-1305)</b> is similar to <b>Time (RFC-868)</b>.</p> <p><b>None.</b> The default, enter the time manually.</p>
Time Server Address	Enter the IP address or domain name of your time server. Check with your ISP/network administrator if you are unsure of this information.
Current Time New Time	<p>This field displays an updated time only when you reenter this menu.</p> <p>Enter the new time in hour, minute and second format.</p>
Current Date New Date	<p>This field displays an updated date only when you re-enter this menu.</p> <p>Enter the new date in year, month and day format.</p>
Time Zone	Press [SPACE BAR] and then [ENTER] to set the time difference between your time zone and Greenwich Mean Time (GMT).
Daylight Saving Start Date End Date	<p>If you use daylight savings time, then choose <b>Yes</b>.</p> <p>If using daylight savings time, enter the month and day that it starts on.</p> <p>If using daylight savings time, enter the month and day that it ends on</p>
Once you have filled in this menu, press [ENTER] at the message "Press ENTER to Confirm or ESC to Cancel" to save your configuration, or press [ESC] to cancel.	

### 24.3.1 Resetting the Time

The Prestige resets the time in three instances:

- i. On leaving menu 24.10 after making changes.
- ii. When the Prestige starts up, if there is a time server configured in menu 24.10.
- iii. 24-hour intervals after starting.



# Chapter 25

## Remote Management

*This chapter covers remote management (SMT menu 24.11).*

### 25.1 Remote Management Overview

Remote management allows you to determine which services/protocols can access which Prestige interface (if any) from which computers.

### 25.2 Configuring Remote Management

To disable remote management of a service, select **Disable** in the corresponding **Server Access** field.

Enter 11 from menu 24 to display **Menu 24.11 — Remote Management Control**.

#### 25.2.1 Remote Management Setup

You may manage your Prestige from a remote location via:

the Internet (**WAN only**), the **LAN only**, **All** (LAN and WAN) or **Disable** (neither).

- WAN only (Internet)
- ALL (LAN and WAN)
- LAN only
- Disable (Neither)

**If you enable remote management of a service, but have applied a filter to block the service, then you will not be able to remotely manage the service.**

Enter 11, from menu 24, to display **Menu 24.11 — Remote Management Control** (shown next).

```

Menu 24.11 - Remote Management Control

TELNET Server:
  Server Port = 23           Server Access = LAN only
  Secured Client IP = 0.0.0.0

FTP Server:
  Server Port = 21           Server Access = LAN only
  Secured Client IP = 0.0.0.0

Web Server:
  Server Port = 80           Server Access = LAN only
  Secured Client IP = 0.0.0.0

Press ENTER to Confirm or ESC to Cancel:
    
```

**Figure 25-1 Menu 24.11 Remote Management Control**

The following table describes the fields in this menu.

**Table 25-1 Menu 24.11 Remote Management Control**

FIELD	DESCRIPTION	EXAMPLE
Telnet Server FTP Server Web Server	Each of these read-only labels denotes a service that you may use to remotely manage the Prestige.	
Server Port	This field shows the port number for the remote management service. You may change the port number for a service if needed, but you must use the same port number to use that service for remote management.	23
Server Access	Select the access interface (if any) by pressing the [SPACE BAR]. Choices are: <b>LAN only</b> , <b>WAN only</b> , <b>All</b> or <b>Disable</b> . The default is <b>LAN only</b> .	<b>LAN only</b>
Secured Client IP	The default 0.0.0.0 allows any client to use this service to remotely manage the Prestige. Enter an IP address to restrict access to a client with a matching IP address.	0.0.0.0
Once you have filled in this menu, press [ENTER] at the message "Press ENTER to Confirm or ESC to Cancel" to save your configuration, or press [ESC] to cancel.		

## 25.2.2 Remote Management Limitations

Remote management over LAN or WAN will not work when:

1. A filter in menu 3.1 (LAN) or in menu 11.5 (WAN) is applied to block a Telnet, FTP or Web service.

2. You have disabled that service in menu 24.11.
3. The IP address in the **Secured Client IP** field (menu 24.11) does not match the client IP address. If it does not match, the Prestige will disconnect the session immediately.
4. There is already another remote management session of the same type (Telnet, FTP or Web) running. You may only have one remote management session of the same type running at one time.
5. There is a web remote management session running with a Telnet session. A Telnet session will be disconnected if you begin a web session; it will not begin if there already is a web session.

## 25.3 Remote Management and NAT

When NAT is enabled:

- Use the Prestige's WAN IP address when configuring from the WAN.
- Use the Prestige's LAN IP address when configuring from the LAN.

## 25.4 System Timeout

There is a system timeout of five minutes (300 seconds) for Telnet/web/FTP connections. Your Prestige will automatically log you out if you do nothing in this timeout period, except when it is continuously updating the status in menu 24.1 or when `sys stdio` has been changed on the command line.





# Chapter 26

## IP Policy Routing

*This chapter covers setting and applying policies used for IP routing.*

### 26.1 IP Policy Routing Overview

Traditionally, routing is based on the destination address only and the IAD takes the shortest path to forward a packet. IP Routing Policy (IPPR) provides a mechanism to override the default routing behavior and alter the packet forwarding based on the policy defined by the network administrator. Policy-based routing is applied to incoming packets on a per interface basis, prior to the normal routing.

### 26.2 Benefits of IP Policy Routing

- Source-Based Routing – Network administrators can use policy-based routing to direct traffic from different users through different connections.
- Quality of Service (QoS) – Organizations can differentiate traffic by setting the precedence or TOS (Type of Service) values in the IP header at the periphery of the network to enable the backbone to prioritize traffic.
- Cost Savings – IPPR allows organizations to distribute interactive traffic on high-bandwidth, high-cost paths while using low-cost paths for batch traffic.
- Load Sharing – Network administrators can use IPPR to distribute traffic among multiple paths.

### 26.3 Routing Policy

Individual routing policies are used as part of the overall IPPR process. A policy defines the matching criteria and the action to take when a packet meets the criteria. The action is taken only when all the criteria are met. The criteria includes the source address and port, IP protocol (ICMP, UDP, TCP, etc.), destination address and port, TOS and precedence (fields in the IP header) and length. The inclusion of length criterion is to differentiate between interactive and bulk traffic. Interactive applications, for example, telnet, tend to have short packets, while bulk traffic, for example, file transfer, tends to have large packets.

The actions that can be taken include:

- routing the packet to a different gateway (and hence the outgoing interface).
- setting the TOS and precedence fields in the IP header.

IPPR follows the existing packet filtering facility of RAS in style and in implementation. The policies are divided into sets, where related policies are grouped together. A user defines the policies before applying them to an interface or a remote node, in the same fashion as the filters. There are 12 policy sets with six policies in each set.

## 26.4 IP Routing Policy Setup

Menu 25 shows all the policies defined.

Menu 25 - IP Routing Policy Setup			
Policy Set #	Name	Policy Set #	Name
1	test	7	_____
2	_____	8	_____
3	_____	9	_____
4	_____	10	_____
5	_____	11	_____
6	_____	12	_____

Enter Policy Set Number to Configure= 0  
 Edit Name= N/A  
 Press ENTER to Confirm or ESC to Cancel:

**Figure 26-1 Menu 25 IP Routing Policy Setup**

To setup a routing policy, perform the following procedures:

- Step 1.** Type 25 in the main menu to open **Menu 25 – IP Routing Policy Setup**.
- Step 2.** Type the index of the policy set you want to configure to open **Menu 25.1 – IP Routing Policy Setup**.

Menu 25.1 shows the summary of a policy set, including the criteria and the action of a single policy, and whether a policy is active or not. Each policy contains two lines. The former part is the criteria of the incoming packet and the latter is the action. Between these two parts, separator “|” means the action is taken on criteria matched and separator “=” means the action is taken on criteria not matched.

```

Menu 25.1 - IP Routing Policy Setup

# A          Criteria/Action
- - -----
1 Y SA=1.1.1.1-1.1.1.1,DA=2.2.2.2-2.2.2.5
   SP=20-25,DP=20-25,P=6,T=NM,PR=0      |GW=192.168.1.1,T=MT,PR=0
2 N _____
3 N _____
4 N _____
5 N _____
6 N _____

Enter Policy Rule Number (1-6) to Configure:

```

**Figure 26-2 Menu 25.1 IP Routing Policy Setup****Table 26-1 Menu 25.1 IP Routing Policy Setup**

ABBREVIATION		MEANING
<b>Criterion</b>	SA	Source IP Address
	SP	Source Port
	DA	Destination IP Address
	DP	Destination Port
	P	IP layer 4 protocol number (TCP=6, UDP=17...)
	T	Type of service of incoming packet
	PR	Precedence of incoming packet
<b>Action</b>	GW	Gateway IP address
	T	Outgoing Type of service
	P	Outgoing Precedence
<b>Service</b>	NM	Normal
	MD	Minimum Delay
	MT	Maximum Throughput
	MR	Maximum Reliability
	MC	Minimum Cost

Type a number from 1 to 6 to display **Menu 25.1.1 – IP Routing Policy** (see the next figure). This menu allows you to configure a policy rule.

```

Menu 25.1.1 - IP Routing Policy

Policy Set Name= test
Active= Yes
Criteria:
  IP Protocol      = 6
  Type of Service= Normal      Packet length= 40
  Precedence      = 0          Len Comp= N/A
  Source:
    addr start= 1.1.1.1      end= 1.1.1.1
    port start= 20          end= 20
  Destination:
    addr start= 2.2.2.2      end= 2.2.2.2
    port start= 20          end= 20
  Action= Matched
  Gateway addr    = 192.168.1.1  Log= No
  Type of Service= Max Thruput
  Precedence      = 0

Press ENTER to Confirm or ESC to Cancel:

Press Space Bar to Toggle.

```

**Figure 26-3 Menu 25.1.1 IP Routing Policy**

The following table describes the fields in this menu.

**Table 26-2 Menu 25.1.1 IP Routing Policy**

FIELD	DESCRIPTION
Policy Set Name	This is the policy set name assigned in <b>Menu 25 – IP Routing Policy Setup</b> .
Active	Press [SPACE BAR] and then [ENTER] to select <b>Yes</b> to activate or <b>No</b> to deactivate the policy. Inactive policies are displayed with a minus sign “-“ in SMT menu 25.
Criteria :	
IP Protocol	IP layer 4 protocol, for example, <b>UDP, TCP, ICMP</b> , etc.
Type of Service	Prioritize incoming network traffic by choosing from <b>Don’t Care, Normal, Min Delay, Max Thruput, Min Cost</b> or <b>Max Reliable</b> .
Precedence	Precedence value of the incoming packet. Press [SPACE BAR] and then [ENTER] to select a value from <b>0 to 7</b> or <b>Don’t Care</b> .
Packet Length	Type the length of incoming packets (in bytes). The operators in the <b>Len Comp</b> (next field) apply to packets of this length.

**Table 26-2 Menu 25.1.1 IP Routing Policy**

FIELD	DESCRIPTION
Len Comp	Press [SPACE BAR] and then [ENTER] to choose from <b>Equal, Not Equal, Less, Greater, Less or Equal or Greater or Equal.</b>
Source:	
addr start / end	Source IP address range from start to end.
port start / end	Source port number range from start to end; applicable only for TCP/UDP.
Destination:	
addr start / end	Destination IP address range from start to end.
port start / end	Destination port number range from start to end; applicable only for TCP/UDP.
Action	Specifies whether action should be taken on criteria <b>Matched or Not Matched.</b>
Gateway addr	Defines the outgoing gateway address. The gateway must be on the same subnet as the Prestige if it is on the LAN, otherwise, the gateway must be the IP address of a remote node. The default gateway is specified as 0.0.0.0.
Type of Service	Set the new TOS value of the outgoing packet. Prioritize incoming network traffic by choosing <b>No Change, Normal, Min Delay, Max Thruput, Max Reliable or Min Cost.</b>
Precedence	Set the new outgoing packet precedence value. Values are <b>0 to 7 or No Change.</b>
Log	Press [SPACE BAR] and then [ENTER] to select <b>Yes</b> to make an entry in the system log when a policy is executed.
When you have completed this menu, press [ENTER] at the prompt "Press ENTER to confirm or ESC to cancel" to save your configuration or press [ESC] to cancel and go back to the previous screen.	

## 26.5 Applying an IP Policy

This section shows you where to apply the IP policies after you design them.

### 26.5.1 Ethernet IP Policies

From **Menu 3 — Ethernet Setup**, type 2 to go to **Menu 3.2 — TCP/IP and DHCP Ethernet Setup**.

You can choose up to four IP policy sets (from 12) by typing their numbers separated by commas, for example, 2, 4, 7, 9.

```
Menu 3.2 - TCP/IP and DHCP Ethernet Setup

DHCP Setup:
  DHCP= None
  Client IP Pool Starting Address= N/A
  Size of Client IP Pool= N/A
  Primary DNS Server= N/A
  Secondary DNS Server= N/A
  Remote DHCP Server= N/A
TCP/IP Setup:
  IP Address= 192.168.1.1
  IP Subnet Mask= 255.255.255.0
  RIP Direction= Both
    Version= RIP-2B
  Multicast= IGMP-v2
  IP Policies= 2,4,7,9
  Edit IP Alias= No

Press ENTER to Confirm or ESC to Cancel:
```

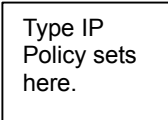

**Figure 26-4 Menu 3.2 TCP/IP and DHCP Ethernet Setup**

Go to menu 11.3 (shown next) and type the number(s) of the IP Routing Policy set(s) as appropriate. You can cascade up to four policy sets by typing their numbers separated by commas.

```
Menu 11.3 - Remote Node Network Layer Options

IP Options:
  IP Address Assignment= Static
  Rem IP Addr= 0.0.0.0
  Rem Subnet Mask= 0.0.0.0
  My WAN Addr= 0.0.0.0
  NAT= Full Feature
  Address Mapping Set= 3
  Metric= 2
  Private= No
  RIP Direction= Both
    Version= RIP-2B
  Multicast= IGMP-v2
  IP Policies= 2,4,7,9

Bridge Options:
  Ethernet Addr Timeout (min)= 0

Press ENTER to Confirm or ESC to Cancel:
```

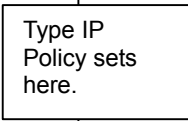

**Figure 26-5 Menu 11.3 Remote Node Network Layer Options**

## 26.6 IP Policy Routing Example

If a network has both Internet and remote node connections, you can route Web packets to the Internet using one policy and route FTP packets to a remote network using another policy. See the next figure.

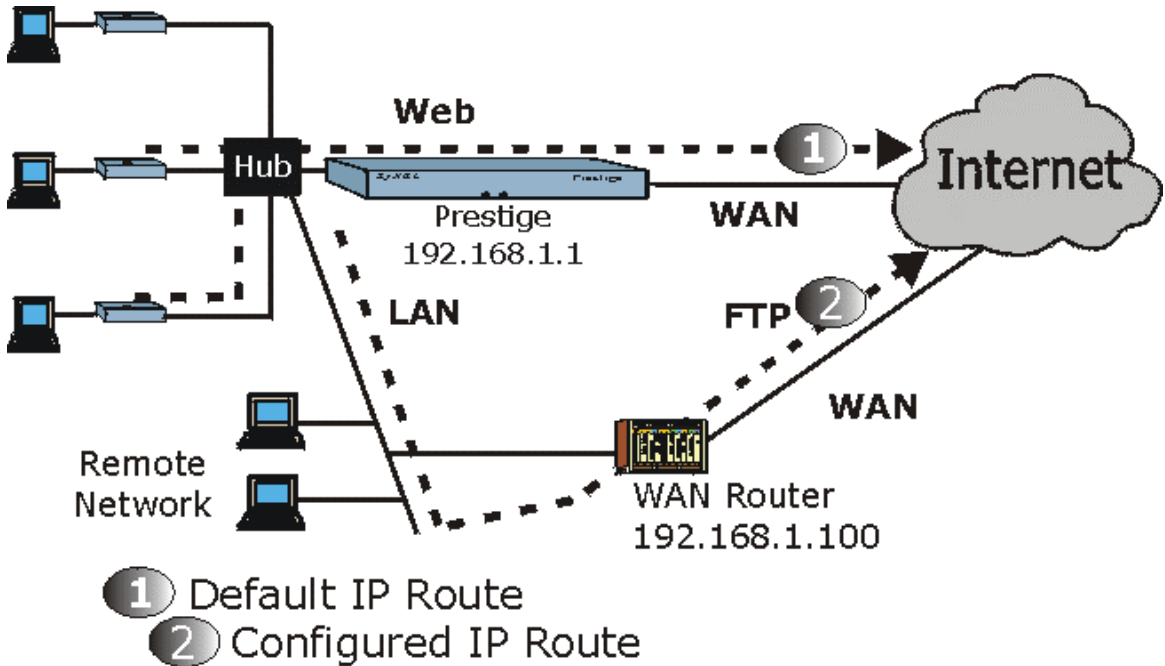

**Figure 26-6 Example of IP Policy Routing**

To force Web packets coming from clients with IP addresses of 192.168.1.33 to 192.168.1.64 to be routed to the Internet via the WAN port of the Prestige, follow the steps as shown next.

**Step 1.** Create a routing policy set in menu 25.

**Step 2.** Create a rule for this set in **Menu 25.1.1 — IP Routing Policy** as shown next.

```
Menu 25.1.1 - IP Routing Policy

Policy Set Name= set1
Active= Yes
Criteria:
  IP Protocol      = 6
  Type of Service= Don't Care
  Precedence      = Don't Care
  Packet length= 10
  Len Comp= N/A
Source:
  addr start= 192.168.1.2      end= 192.168.1.64
  port start= 0              end= N/A
Destination:
  addr start= 0.0.0.0          end= N/A
  port start= 80              end= 80
Action= Matched
  Gateway addr   = 192.168.1.1   Log= No
  Type of Service= No Change
  Precedence     = No Change

Press ENTER to Confirm or ESC to Cancel:
Press Space Bar to Toggle.
```

**Figure 26-7 IP Routing Policy Example**

**Step 3.** Check **Menu 25.1 — IP Routing Policy Setup** to see if the rule is added correctly.

**Step 4.** Create another policy set in menu 25.

**Step 5.** Create a rule in menu 25.1 for this set to route packets from any host (IP=0.0.0.0 means any host) with protocol TCP and port FTP access through another gateway (192.168.1.100).



```

Menu 25.1.1 - IP Routing Policy

Policy Set Name= set2
Active= Yes
Criteria:
  IP Protocol      = 6
  Type of Service= Don't Care           Packet length= 10
  Precedence      = Don't Care           Len Comp= N/A
Source:
  addr start= 0.0.0.0                   end= N/A
  port start= 0                           end= N/A
Destination:
  addr start= 0.0.0.0                   end= N/A
  port start= 20                          end= 21
Action= Matched
Gateway addr =192.168.1.100           Log= No
Type of Service= No Change
Precedence      = No Change

Press ENTER to Confirm or ESC to Cancel:
Press Space Bar to Toggle.

```

**Figure 26-8 IP Routing Policy Example**

**Step 6.** Check **Menu 25.1 — IP Routing Policy Setup** to see if the rule is added correctly.

**Step 7.** Apply both policy sets in menu 3.2 as shown next.

```

Menu 3.2 - TCP/IP and DHCP Ethernet Setup

DHCP Setup
  DHCP= Server
  Client IP Pool Starting Address= 192.168.1.33
  Size of Client IP Pool= 64
  Primary DNS Server= 0.0.0.0
  Secondary DNS Server= 0.0.0.0
  Remote DHCP Server= N/A
TCP/IP Setup:
  IP Address= 192.168.1.1
  IP Subnet Mask= 255.255.255.0
  RIP Direction= Both
  Version= RIP-1
  Multicast= None
IP Policies= 1,2
  Edit IP Alias= No

Press ENTER to Confirm or ESC to Cancel:

Press Space Bar to Toggle.

```

**Figure 26-9 Applying IP Policies Example**



# Chapter 27

## Call Scheduling

*Call scheduling (applicable for PPPoA or PPPoE encapsulation only) allows you to dictate when a remote node should be called and for how long.*

### 27.1 Call Scheduling Overview

The call scheduling feature allows the Prestige to manage a remote node and dictate when a remote node should be called and for how long. This feature is similar to the scheduler in a video cassette recorder (you can specify a time period for the VCR to record). You can apply up to 4 schedule sets in **Menu 11.1 — Remote Node Profile**. From the main menu, enter 26 to access **Menu 26 — Schedule Setup** as shown next.

Menu 26 - Schedule Setup			
Schedule Set #	Name	Schedule Set #	Name
1	AlwaysOn	7	_____
2	_____	8	_____
3	_____	9	_____
4	_____	10	_____
5	_____	11	_____
6	_____	12	_____

Enter Schedule Set Number to Configure=  
 Edit Name=  
 Press ENTER to Confirm or ESC to Cancel:

**Figure 27-1 Menu 26 Schedule Setup**

Lower numbered sets take precedence over higher numbered sets thereby avoiding scheduling conflicts. For example, if sets 1, 2, 3 and 4 in are applied in the remote node then set 1 will take precedence over set 2, 3 and 4 as the Prestige, by default, applies the lowest numbered set first. Set 2 will take precedence over set 3 and 4, and so on.

You can design up to 12 schedule sets but you can only apply up to four schedule sets for a remote node.

**To delete a schedule set, enter the set number and press [SPACE BAR] and then [ENTER] (or delete) in the Edit Name field.**

To setup a schedule set, select the schedule set you want to setup from menu 26 (1-12) and press [ENTER] to see **Menu 26.1 — Schedule Set Setup** as shown next.

```

Menu 26.1 - Schedule Set Setup

Active= Yes
Start Date(yyyy-mm-dd) = 2000 - 01 - 01
How Often= Once
Once:
  Date(yyyy-mm-dd)= 2000 - 01 - 01
Weekdays:
  Sunday= N/A
  Monday= N/A
  Tuesday= N/A
  Wednesday= N/A
  Thursday= N/A
  Friday= N/A
  Saturday= N/A
Start Time (hh:mm)= 00 : 00
Duration (hh:mm)= 00 : 00
Action= Forced On

          Press ENTER to Confirm or ESC to Cancel:
Press Space Bar to Toggle
    
```

**Figure 27-2 Menu 26.1 Schedule Set Setup**

If a connection has been already established, your Prestige will not drop it. Once the connection is dropped manually or it times out, then that remote node can't be triggered up until the end of the **Duration**.

**Table 27-1 Menu 26.1 Schedule Set Setup**

FIELD	DESCRIPTION	EXAMPLE
Active	Press [SPACE BAR] to select <b>Yes</b> or <b>No</b> . Choose <b>Yes</b> and press [ENTER] to activate the schedule set.	<b>Yes</b>
Start Date	Enter the start date when you wish the set to take effect in year - month-date format. Valid dates are from the present to 2036-February-5.	2000-01-01

Table 27-1 Menu 26.1 Schedule Set Setup

FIELD	DESCRIPTION	EXAMPLE
How Often	Should this schedule set recur weekly or be used just once only? Press the [SPACE BAR] and then [ENTER] to select <b>Once</b> or <b>Weekly</b> . Both these options are mutually exclusive. If <b>Once</b> is selected, then all weekday settings are <b>N/A</b> . When <b>Once</b> is selected, the schedule rule deletes automatically after the scheduled time elapses.	<b>Once</b>
Once: Date	If you selected <b>Once</b> in the <b>How Often</b> field above, then enter the date the set should activate here in year-month-date format.	2000-01-01
Weekday: Day	If you selected <b>Weekly</b> in the <b>How Often</b> field above, then select the day(s) when the set should activate (and recur) by going to that day(s) and pressing [SPACE BAR] to select <b>Yes</b> , then press [ENTER].	<b>Yes</b> <b>No</b> <b>N/A</b>
Start Time	Enter the start time when you wish the schedule set to take effect in hour-minute format.	09:00
Duration	Enter the maximum length of time this connection is allowed in hour-minute format.	08:00
Action	<p><b>Forced On</b> means that the connection is maintained whether or not there is a demand call on the line and will persist for the time period specified in the <b>Duration</b> field.</p> <p><b>Forced Down</b> means that the connection is blocked whether or not there is a demand call on the line.</p> <p><b>Enable Dial-On-Demand</b> means that this schedule permits a demand call on the line. <b>Disable Dial-On-Demand</b> means that this schedule prevents a demand call on the line.</p>	<b>Forced On</b>
When you have completed this menu, press [ENTER] at the prompt "Press ENTER to confirm or ESC to cancel" to save your configuration or press [ESC] to cancel and go back to the previous screen.		

Once your schedule sets are configured, you must then apply them to the desired remote node(s). Enter 11 from the **Main Menu** and then enter the target remote node index. Using [SPACE BAR], select **PPPoE** or **PPPoA** in the **Encapsulation** field and then press [ENTER] to make the schedule sets field available as shown next.

```
Menu 11.1 - Remote Node Profile

Rem Node Name= ChangeMe      Route= IP
Active= Yes                  Bridge= No

Encapsulation= PPPoE        Edit IP/Bridge= No
Multiplexing=VC-based       Edit ATM Options= No
Service Name=              Telco Option:
Incoming                    Allocated Budget(min)= 0
  Rem Login=                Period(hr)= 0
  Rem Password= *****    Schedules= 1,2,3,4
Outgoing=                   Nailed-Up Connection= No
  My Login=?
  My Password= *****
  Authen= CHAP/PAP

Session Options:
  Edit Filter Sets= No
  Idle Timeout(sec)= 100

Press ENTER to Confirm or ESC to Cancel:
```

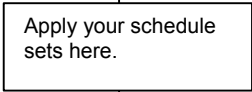

**Figure 27-3 Applying Schedule Set(s) to a Remote Node (PPPoE)**

You can apply up to four schedule sets, separated by commas, for one remote node. Change the schedule set numbers to your preference(s).

---

---

# Part VIII:

---

---

## Appendices and Index

---

This part contains troubleshooting, additional background information and an index of key terms.





# Appendix A

## Troubleshooting

*This chapter covers potential problems and the corresponding remedies.*

### A.1 Using LEDs to Diagnose Problems

The LEDs are useful aides for finding possible problem causes.

#### A.1.1 Power LED

The **PWR** LED on the front panel does not light up.

**Chart A-1 Troubleshooting Power LED**

STEPS	CORRECTIVE ACTION
1	Make sure that the Prestige's power adaptor is connected to the Prestige and plugged in to an appropriate power source. Use only the supplied power adaptor.
2	Check that the Prestige and the power source are both turned on and the Prestige is receiving sufficient power.
3	Turn the Prestige off and on.
4	If the error persists, you may have a hardware problem. In this case, you should contact your vendor.

#### A.1.2 LAN LED

The **LAN** LED on the front panel does not light up.

**Chart A-2 Troubleshooting LAN LED**

STEPS	CORRECTIVE ACTION
1	Check the Ethernet cable connections between your Prestige and the computer or hub.
2	Check for faulty Ethernet cables.
3	Make sure your computer's Ethernet card is working properly.
4	If these steps fail to correct the problem, contact your local distributor for assistance.

### A.1.3 DSL LED

The **DSL** LED on the front panel does not light up.

**Chart A-3 Troubleshooting DSL LED**

STEPS	CORRECTIVE ACTION
1	Check the telephone wire and connections between the Prestige DSL port and the wall jack.
2	Make sure that the telephone company has checked your phone line and set it up for DSL service.
3	Reset your ADSL line to reinitialize your link to the DSLAM. For details, refer to the <i>Maintenance</i> chapter (web configurator) or the System Information and Diagnosis chapter (SMT).
4	If these steps fail to correct the problem, contact your local distributor for assistance.

### A.2 Telnet

I cannot telnet into the Prestige.

**Chart A-4 Troubleshooting Telnet**

STEPS	CORRECTIVE ACTION
1	Check the LAN port and the other Ethernet connections.
2	Make sure you are using the correct IP address of the Prestige. Check the IP address of the Prestige.
3	Ping the Prestige from your computer.  If you cannot ping the Prestige, check the IP addresses of the Prestige and your computer. Make sure your computer is set to get a dynamic IP address; or if you want to use a static IP address on your computer, make sure that it is on the same subnet as the Prestige.
4	Make sure you entered the correct username and password. The default username is “admin” and the default password is “1234”.  If you have forgot your username or password, refer to <i>Section A.4</i> .
5	If these steps fail to correct the problem, contact the distributor.

## A.3 Web Configurator

I cannot access the web configurator.

**Chart A-5 Troubleshooting Web Configurator**

STEPS	CORRECTIVE ACTION
1	Make sure you are using the correct IP address of the Prestige. Check the IP address of the Prestige.
2	Make sure that there is not an SMT console session running.
3	Your computer's and the Prestige's IP addresses must be on the same subnet for LAN access.
4	If you changed the Prestige's LAN IP address, then enter the new one as the URL.
5	Remove any filters in SMT menu 3.1 (LAN) or menu 11.5 (WAN) that block web service.

The web configurator does not display properly.

**Chart A-6 Troubleshooting Internet Browser Display**

STEPS	CORRECTIVE ACTION
1	Make sure you are using Internet Explorer 5.0 and later versions.
2	Delete the temporary web files and log in again.  In Internet Explorer, click <b>Tools, Internet Options</b> and then click the <b>Delete Files ...</b> button. When a <b>Delete Files</b> window displays, select <b>Delete all offline content</b> and click <b>OK</b> . (Steps may vary depending on the version of your Internet browser.)

## A.4 Login Username and Password

I forgot my login username and/or password.

**Chart A-7 Troubleshooting Login Username and Password**

STEPS	CORRECTIVE ACTION
1	If you have changed the password and have now forgotten it, you will need to upload the default configuration file. This will erase all custom configurations and restore all of the factory defaults including the password.
2	Press the <b>RESET</b> button for five seconds, and then release it. When the <b>SYS</b> LED begins to blink, the defaults have been restored and the Prestige restarts.

**Chart A-7 Troubleshooting Login Username and Password**

STEPS	CORRECTIVE ACTION
3	The default username is “admin”. The default password is “1234”. The <b>Password</b> and <b>Username</b> fields are case-sensitive. Make sure that you enter the correct password and username using the proper casing.
4	It is highly recommended to change the default username and password. Make sure you store the username and password in a safe place.

**A.5 LAN Interface**

I cannot access the Prestige from the LAN or ping any computer on the LAN.

**Chart A-8 Troubleshooting LAN Interface**

STEPS	CORRECTIVE ACTION
1	Check the Ethernet LEDs on the front panel. A LAN LED should be on if the port is connected to a computer or hub. If the 10M/100M LEDs on the front panel are both off, refer to <i>Section A.1.2</i> .
2	Make sure that the IP address and the subnet mask of the Prestige and your computer(s) are on the same subnet.

**A.6 WAN Interface**

Initialization of the ADSL connection failed.

**Chart A-9 Troubleshooting ADSL Connection**

STEPS	CORRECTIVE ACTION
1	Check the cable connections between the ADSL port and the wall jack. The DSL LED on the front panel of the Prestige should be on.
2	Check that your VPI, VCI, type of encapsulation and type of multiplexing settings are the same as what you collected from your telephone company and ISP.
3	Restart the Prestige. If you still have problems, you may need to verify your VPI, VCI, type of encapsulation and type of multiplexing settings with the telephone company and ISP.

I cannot get a WAN IP address from the ISP.

### Chart A-10 Troubleshooting WAN Interface

STEPS	CORRECTIVE ACTION
1	The ISP provides the WAN IP address after authenticating you. Authentication may be through the user name and password, the MAC address or the host name.
2	The username and password apply to PPPoE and PPPoA encapsulation only. Make sure that you have entered the correct <b>Service Type</b> , <b>User Name</b> and <b>Password</b> (be sure to use the correct casing). Refer to the <i>WAN Setup</i> chapter (web configurator) or the <i>Internet Access</i> chapter (SMT).

## A.7 Internet Access

I cannot access the Internet.

### Chart A-11 Troubleshooting Internet Access

STEPS	CORRECTIVE ACTION
1	Make sure the Prestige is turned on and connected to the network.
2	If the DSL LED is off, refer to <i>Section A.1.3</i> .
3	Verify your WAN settings. Refer to the <i>WAN Setup</i> chapter (web configurator) or the <i>Internet Access</i> chapter (SMT).
4	Make sure you entered the correct user name and password.
5	(In Germany) Make sure you have a UR-2 line. Contact your local telephone company for more information.

Internet connection disconnects.

### Chart A-12 Troubleshooting Internet Connection

STEPS	CORRECTIVE ACTION
1	Check the schedule rules. Refer to the <i>Call Scheduling</i> chapter (SMT).
2	If you use PPPoA or PPPoE encapsulation, check the idle time-out setting. Refer to the <i>WAN</i> chapter (web configurator) or the <i>Remote Node Configuration</i> chapter (SMT).
3	Contact your ISP.

## A.8 Remote Node Connection

I cannot connect to a remote node or ISP.

**Chart A-13 Troubleshooting Connecting to a Remote Node or ISP**

<b>STEPS</b>	<b>CORRECTIVE ACTION</b>
1	Check menu 4 or WAN screen to verify that the username and password are entered properly.
2	In menu 11.1, verify your login name and password for the remote node.
3	If these steps fail, you may need to verify your login and password with your ISP.

# Appendix B

## IP Subnetting

### IP Addressing

Routers “route” based on the network number. The router that delivers the data packet to the correct destination host uses the host ID.

### IP Classes

An IP address is made up of four octets (eight bits), written in dotted decimal notation, for example, 192.168.1.1. IP addresses are categorized into different classes. The class of an address depends on the value of its first octet.

- Class “A” addresses have a 0 in the left most bit. In a class “A” address the first octet is the network number and the remaining three octets make up the host ID.
- Class “B” addresses have a 1 in the left most bit and a 0 in the next left most bit. In a class “B” address the first two octets make up the network number and the two remaining octets make up the host ID.
- Class “C” addresses begin (starting from the left) with 1 1 0. In a class “C” address the first three octets make up the network number and the last octet is the host ID.
- Class “D” addresses begin with 1 1 1 0. Class “D” addresses are used for multicasting. (There is also a class “E” address. It is reserved for future use.)

**Chart B-1 Classes of IP Addresses**

IP ADDRESS:		OCTET 1	OCTET 2	OCTET 3	OCTET 4
Class A	0	Network number	Host ID	Host ID	Host ID
Class B	10	Network number	Network number	Host ID	Host ID
Class C	110	Network number	Network number	Network number	Host ID

**Host IDs of all zeros or all ones are not allowed.**

Therefore:

- A class “C” network (8 host bits) can have  $2^8 - 2$  or 254 hosts.
- A class “B” address (16 host bits) can have  $2^{16} - 2$  or 65534 hosts.

A class “A” address (24 host bits) can have  $2^{24} - 2$  hosts (approximately 16 million hosts).

Since the first octet of a class “A” IP address must contain a “0”, the first octet of a class “A” address can have a value of 0 to 127.

Similarly the first octet of a class “B” must begin with “10”, therefore the first octet of a class “B” address has a valid range of 128 to 191. The first octet of a class “C” address begins with “110”, and therefore has a range of 192 to 223.

**Chart B-2 Allowed IP Address Range By Class**

CLASS	ALLOWED RANGE OF FIRST OCTET (BINARY)	ALLOWED RANGE OF FIRST OCTET (DECIMAL)
Class A	00000000 to 01111111	0 to 127
Class B	10000000 to 10111111	128 to 191
Class C	11000000 to 11011111	192 to 223
Class D	11100000 to 11101111	224 to 239

### Subnet Masks

A subnet mask is used to determine which bits are part of the network number, and which bits are part of the host ID (using a logical AND operation). A subnet mask has 32 bits; each bit of the mask corresponds to a bit of the IP address. If a bit in the subnet mask is a “1” then the corresponding bit in the IP address is part of the network number. If a bit in the subnet mask is “0” then the corresponding bit in the IP address is part of the host ID.

Subnet masks are expressed in dotted decimal notation just as IP addresses are. The “natural” masks for class A, B and C IP addresses are as follows.

**Chart B-3 “Natural” Masks**

CLASS	NATURAL MASK
A	255.0.0.0
B	255.255.0.0
C	255.255.255.0

### Subnetting

With subnetting, the class arrangement of an IP address is ignored. For example, a class C address no longer has to have 24 bits of network number and 8 bits of host ID. With subnetting, some of the host ID bits are converted into network number bits. By convention, subnet masks always consist of a continuous sequence



of ones beginning from the left most bit of the mask, followed by a continuous sequence of zeros, for a total number of 32 bits.

Since the mask is always a continuous number of ones beginning from the left, followed by a continuous number of zeros for the remainder of the 32 bit mask, you can simply specify the number of ones instead of writing the value of each octet. This is usually specified by writing a “/” followed by the number of bits in the mask after the address.

For example, 192.1.1.0 /25 is equivalent to saying 192.1.1.0 with mask 255.255.255.128.

The following table shows all possible subnet masks for a class “C” address using both notations.

**Chart B-4 Alternative Subnet Mask Notation**

SUBNET MASK IP ADDRESS	SUBNET MASK “1” BITS	LAST OCTET BIT VALUE
255.255.255.0	/24	0000 0000
255.255.255.128	/25	1000 0000
255.255.255.192	/26	1100 0000
255.255.255.224	/27	1110 0000
255.255.255.240	/28	1111 0000
255.255.255.248	/29	1111 1000
255.255.255.252	/30	1111 1100

The first mask shown is the class “C” natural mask. Normally if no mask is specified it is understood that the natural mask is being used.

**Example: Two Subnets**

As an example, you have a class “C” address 192.168.1.0 with subnet mask of 255.255.255.0.

	NETWORK NUMBER	HOST ID
IP Address	192.168.1.	0
IP Address (Binary)	11000000.10101000.00000001.	00000000
Subnet Mask	255.255.255.	0
Subnet Mask (Binary)	11111111.11111111.11111111.	00000000

The first three octets of the address make up the network number (class “C”). You want to have two separate networks.

Divide the network 192.168.1.0 into two separate subnets by converting one of the host ID bits of the IP address to a network number bit. The “borrowed” host ID bit can be either “0” or “1” thus giving two subnets; 192.168.1.0 with mask 255.255.255.128 and 192.168.1.128 with mask 255.255.255.128.

**In the following charts, shaded/bolded last octet bit values indicate host ID bits “borrowed” to form network ID bits. The number of “borrowed” host ID bits determines the number of subnets you can have. The remaining number of host ID bits (after “borrowing”) determines the number of hosts you can have on each subnet.**

**Chart B-5 Subnet 1**

	<b>NETWORK NUMBER</b>	<b>LAST OCTET BIT VALUE</b>
IP Address	192.168.1.	0
IP Address (Binary)	11000000.10101000.00000001.	<b>00000000</b>
Subnet Mask	255.255.255.	128
Subnet Mask (Binary)	11111111.11111111.11111111.	<b>10000000</b>
Subnet Address: 192.168.1.0		Lowest Host ID: 192.168.1.1
Broadcast Address: 192.168.1.127		Highest Host ID: 192.168.1.126

**Chart B-6 Subnet 2**

	<b>NETWORK NUMBER</b>	<b>LAST OCTET BIT VALUE</b>
IP Address	192.168.1.	128
IP Address (Binary)	11000000.10101000.00000001.	<b>10000000</b>
Subnet Mask	255.255.255.	128
Subnet Mask (Binary)	11111111.11111111.11111111.	<b>10000000</b>
Subnet Address: 192.168.1.128		Lowest Host ID: 192.168.1.129
Broadcast Address: 192.168.1.255		Highest Host ID: 192.168.1.254

The remaining 7 bits determine the number of hosts each subnet can have. Host IDs of all zeros represent the subnet itself and host IDs of all ones are the broadcast address for that subnet, so the actual number of hosts available on each subnet in the example above is  $2^7 - 2$  or 126 hosts for each subnet.

192.168.1.0 with mask 255.255.255.128 is the subnet itself, and 192.168.1.127 with mask 255.255.255.128 is the directed broadcast address for the first subnet. Therefore, the lowest IP address that can be assigned to an

actual host for the first subnet is 192.168.1.1 and the highest is 192.168.1.126. Similarly the host ID range for the second subnet is 192.168.1.129 to 192.168.1.254.

### Example: Four Subnets

The above example illustrated using a 25-bit subnet mask to divide a class “C” address space into two subnets. Similarly to divide a class “C” address into four subnets, you need to “borrow” two host ID bits to give four possible combinations of 00, 01, 10 and 11. The subnet mask is 26 bits (11111111.11111111.11111111.11000000) or 255.255.255.192. Each subnet contains 6 host ID bits, giving  $2^6 - 2$  or 62 hosts for each subnet (all 0’s is the subnet itself, all 1’s is the broadcast address on the subnet).

**Chart B-7 Subnet 1**

	NETWORK NUMBER	LAST OCTET BIT VALUE
IP Address	192.168.1.	0
IP Address (Binary)	11000000.10101000.00000001.	00000000
Subnet Mask (Binary)	11111111.11111111.11111111.	11000000
Subnet Address: 192.168.1.0	Lowest Host ID: 192.168.1.1	
Broadcast Address: 192.168.1.63	Highest Host ID: 192.168.1.62	

**Chart B-8 Subnet 2**

	NETWORK NUMBER	LAST OCTET BIT VALUE
IP Address	192.168.1.	64
IP Address (Binary)	11000000.10101000.00000001.	01000000
Subnet Mask (Binary)	11111111.11111111.11111111.	11000000
Subnet Address: 192.168.1.64	Lowest Host ID: 192.168.1.65	
Broadcast Address: 192.168.1.127	Highest Host ID: 192.168.1.126	

**Chart B-9 Subnet 3**

	NETWORK NUMBER	LAST OCTET BIT VALUE
IP Address	192.168.1.	128
IP Address (Binary)	11000000.10101000.00000001.	10000000
Subnet Mask (Binary)	11111111.11111111.11111111.	11000000
Subnet Address: 192.168.1.128	Lowest Host ID: 192.168.1.129	
Broadcast Address: 192.168.1.191	Highest Host ID: 192.168.1.190	

**Chart B-10 Subnet 4**

	NETWORK NUMBER	LAST OCTET BIT VALUE
IP Address	192.168.1.	192
IP Address (Binary)	11000000.10101000.00000001.	11000000
Subnet Mask (Binary)	11111111.11111111.11111111.	11000000
Subnet Address: 192.168.1.192	Lowest Host ID: 192.168.1.193	
Broadcast Address: 192.168.1.255	Highest Host ID: 192.168.1.254	

**Example Eight Subnets**

Similarly use a 27-bit mask to create 8 subnets (001, 010, 011, 100, 101, 110).

The following table shows class C IP address last octet values for each subnet.

**Chart B-11 Eight Subnets**

SUBNET	SUBNET ADDRESS	FIRST ADDRESS	LAST ADDRESS	BROADCAST ADDRESS
1	0	1	30	31
2	32	33	62	63
3	64	65	94	95
4	96	97	126	127
5	128	129	158	159
6	160	161	190	191
7	192	193	222	223
8	224	223	254	255

The following table is a summary for class “C” subnet planning.

**Chart B-12 Class C Subnet Planning**

NO. "BORROWED" HOST BITS	SUBNET MASK	NO. SUBNETS	NO. HOSTS PER SUBNET
1	255.255.255.128 (/25)	2	126
2	255.255.255.192 (/26)	4	62
3	255.255.255.224 (/27)	8	30
4	255.255.255.240 (/28)	16	14
5	255.255.255.248 (/29)	32	6
6	255.255.255.252 (/30)	64	2
7	255.255.255.254 (/31)	128	1

**Subnetting With Class A and Class B Networks.**

For class "A" and class "B" addresses the subnet mask also determines which bits are part of the network number and which are part of the host ID.

A class "B" address has two host ID octets available for subnetting and a class "A" address has three host ID octets (see *Chart B-1*) available for subnetting.

The following table is a summary for class "B" subnet planning.

**Chart B-13 Class B Subnet Planning**

NO. "BORROWED" HOST BITS	SUBNET MASK	NO. SUBNETS	NO. HOSTS PER SUBNET
1	255.255.128.0 (/17)	2	32766
2	255.255.192.0 (/18)	4	16382
3	255.255.224.0 (/19)	8	8190
4	255.255.240.0 (/20)	16	4094
5	255.255.248.0 (/21)	32	2046
6	255.255.252.0 (/22)	64	1022
7	255.255.254.0 (/23)	128	510
8	255.255.255.0 (/24)	256	254
9	255.255.255.128 (/25)	512	126

**Chart B-13 Class B Subnet Planning**

<b>NO. "BORROWED" HOST BITS</b>	<b>SUBNET MASK</b>	<b>NO. SUBNETS</b>	<b>NO. HOSTS PER SUBNET</b>
10	255.255.255.192 (/26)	1024	62
11	255.255.255.224 (/27)	2048	30
12	255.255.255.240 (/28)	4096	14
13	255.255.255.248 (/29)	8192	6
14	255.255.255.252 (/30)	16384	2
15	255.255.255.254 (/31)	32768	1

# Appendix C

## PPPoE

### PPPoE in Action

An ADSL modem bridges a PPP session over Ethernet (PPP over Ethernet, RFC 2516) from your PC to an ATM PVC (Permanent Virtual Circuit) which connects to a xDSL Access Concentrator where the PPP session terminates (see the next figure). One PVC can support any number of PPP sessions from your LAN. PPPoE provides access control and billing functionality in a manner similar to dial-up services using PPP.

### Benefits of PPPoE

PPPoE offers the following benefits:

1. It provides you with a familiar dial-up networking (DUN) user interface.
2. It lessens the burden on the carriers of provisioning virtual circuits all the way to the ISP on multiple switches for thousands of users. For GSTN (PSTN and ISDN), the switching fabric is already in place.
3. It allows the ISP to use the existing dial-up model to authenticate and (optionally) to provide differentiated services.

### Traditional Dial-up Scenario

The following diagram depicts a typical hardware configuration where the PCs use traditional dial-up networking.

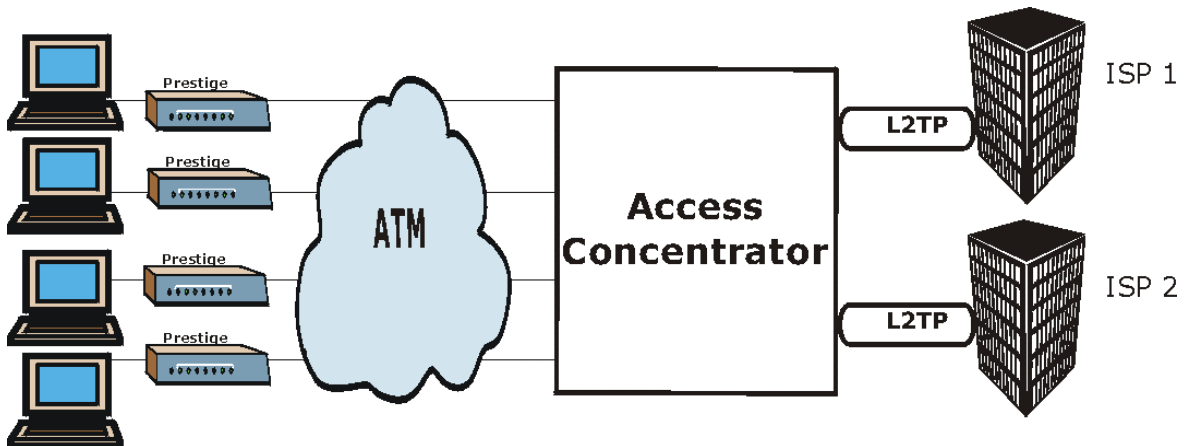

Diagram C-1 Single-PC per Router Hardware Configuration

## How PPPoE Works

The PPPoE driver makes the Ethernet appear as a serial link to the PC and the PC runs PPP over it, while the modem bridges the Ethernet frames to the Access Concentrator (AC). Between the AC and an ISP, the AC is acting as a L2TP (Layer 2 Tunneling Protocol) LAC (L2TP Access Concentrator) and tunnels the PPP frames to the ISP. The L2TP tunnel is capable of carrying multiple PPP sessions.

With PPPoE, the VC (Virtual Circuit) is equivalent to the dial-up connection and is between the modem and the AC, as opposed to all the way to the ISP. However, the PPP negotiation is between the PC and the ISP.

## Prestige as a PPPoE Client

When using the Prestige as a PPPoE client, the PCs on the LAN see only Ethernet and are not aware of PPPoE. This alleviates the administrator from having to manage the PPPoE clients on the individual PCs.

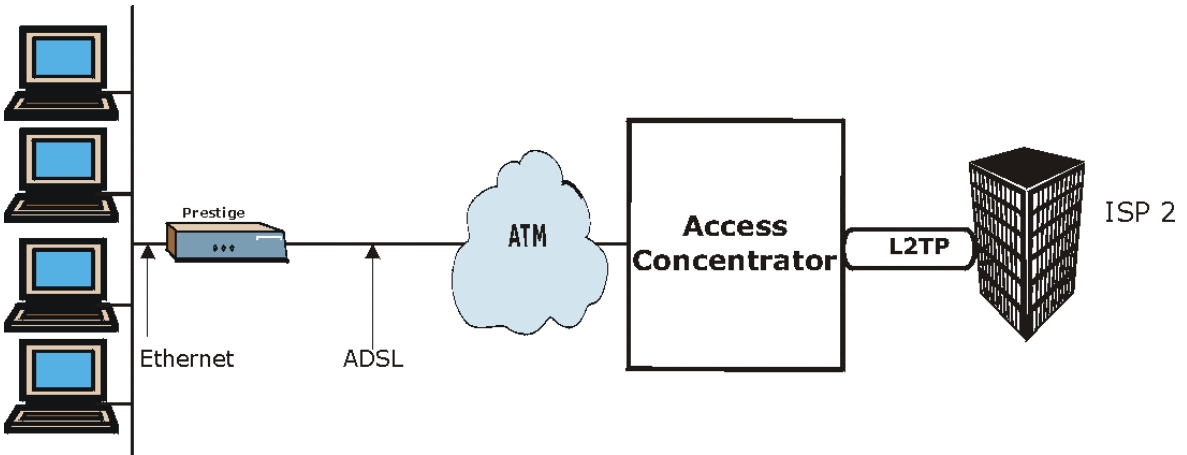

Diagram C-2 Prestige as a PPPoE Client



# Appendix D

## Setting up Your Computer's IP Address

All computers must have a 10M or 100M Ethernet adapter card and TCP/IP installed.

Windows 95/98/Me/NT/2000/XP, Macintosh OS 7 and later operating systems and all versions of UNIX/LINUX include the software components you need to install and use TCP/IP on your computer. Windows 3.1 requires the purchase of a third-party TCP/IP application package.

TCP/IP should already be installed on computers using Windows NT/2000/XP, Macintosh OS 7 and later operating systems.

After the appropriate TCP/IP components are installed, configure the TCP/IP settings in order to "communicate" with your network.

If you manually assign IP information instead of using dynamic assignment, make sure that your computers have IP addresses that place them in the same subnet as the Prestige's LAN port.

### Windows 95/98/Me

Click **Start, Settings, Control Panel** and double-click the **Network** icon to open the **Network** window.

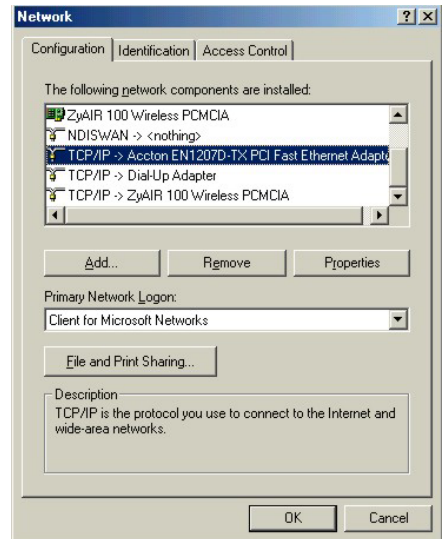

## Installing Components

The **Network** window **Configuration** tab displays a list of installed components. You need a network adapter, the TCP/IP protocol and Client for Microsoft Networks.

If you need the adapter:

- a. In the **Network** window, click **Add**.
- b. Select **Adapter** and then click **Add**.
- c. Select the manufacturer and model of your network adapter and then click **OK**.

If you need TCP/IP:

- a. In the **Network** window, click **Add**.
- b. Select **Protocol** and then click **Add**.
- c. Select **Microsoft** from the list of **manufacturers**.
- d. Select **TCP/IP** from the list of network protocols and then click **OK**.

If you need Client for Microsoft Networks:

- a. Click **Add**.
- b. Select **Client** and then click **Add**.
- c. Select **Microsoft** from the list of manufacturers.
- d. Select **Client for Microsoft Networks** from the list of network clients and then click **OK**.
- e. Restart your computer so the changes you made take effect.

## Configuring

1. In the **Network** window **Configuration** tab, select your network adapter's TCP/IP entry and click **Properties**.

2. Click the **IP Address** tab.

-If your IP address is dynamic, select **Obtain an IP address automatically**.

-If you have a static IP address, select **Specify an IP address** and type your information into the **IP Address** and **Subnet Mask** fields.

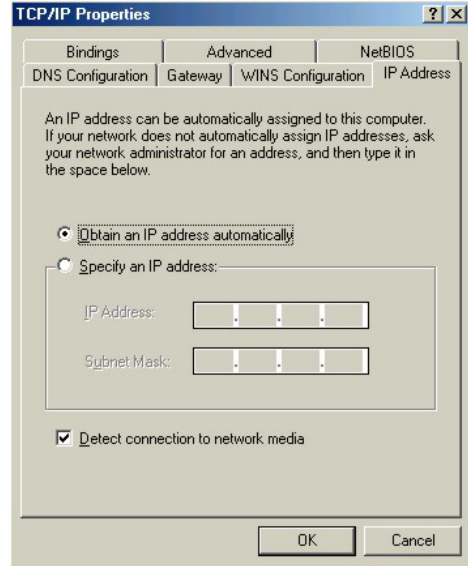

3. Click the **DNS Configuration** tab.

-If you do not know your DNS information, select **Disable DNS**.

-If you know your DNS information, select **Enable DNS** and type the information in the fields below (you may not need to fill them all in).

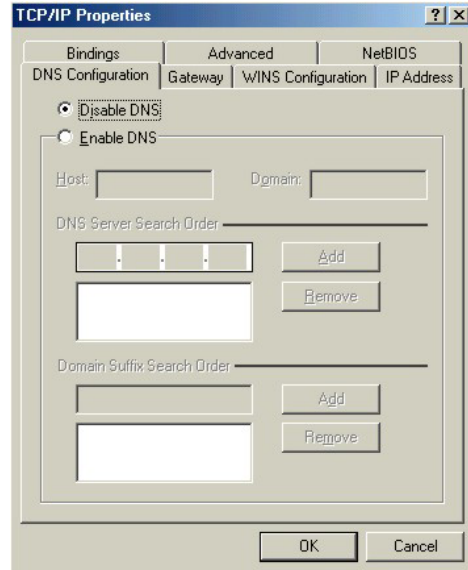

4. Click the **Gateway** tab.  
-If you do not know your gateway's IP address, remove previously installed gateways.  
-If you have a gateway IP address, type it in the **New gateway field** and click **Add**.

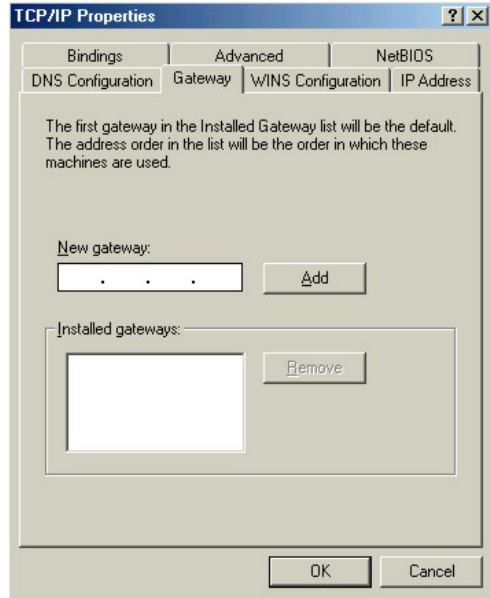

5. Click **OK** to save and close the **TCP/IP Properties** window.
6. Click **OK** to close the **Network** window. Insert the Windows CD if prompted.
7. Turn on your Prestige and restart your computer when prompted.

### Verifying Settings

1. Click **Start** and then **Run**.
2. In the **Run** window, type "winipcfg" and then click **OK** to open the **IP Configuration** window.
3. Select your network adapter. You should see your computer's IP address, subnet mask and default gateway.

## Windows 2000/NT/XP

1. For Windows XP, click **start, Control Panel**. In Windows 2000/NT, click **Start, Settings, Control Panel**.



2. For Windows XP, click **Network Connections**. For Windows 2000/NT, click **Network and Dial-up Connections**.

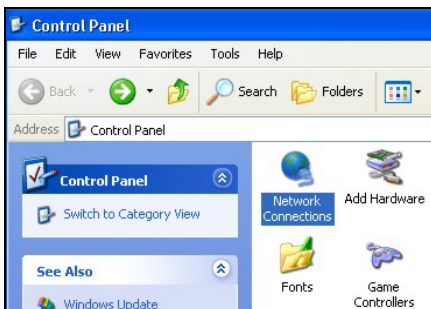

3. Right-click **Local Area Connection** and then click **Properties**.

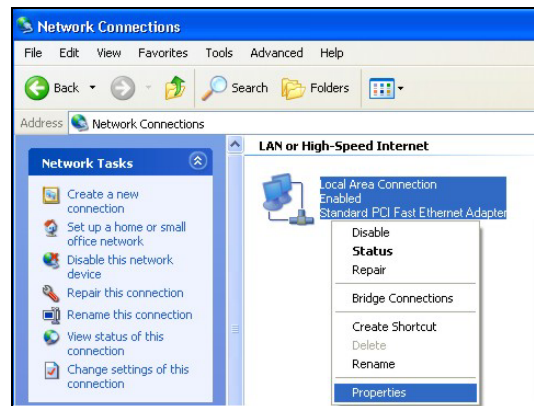

4. Select **Internet Protocol (TCP/IP)** (under the **General** tab in Win XP) and click **Properties**.

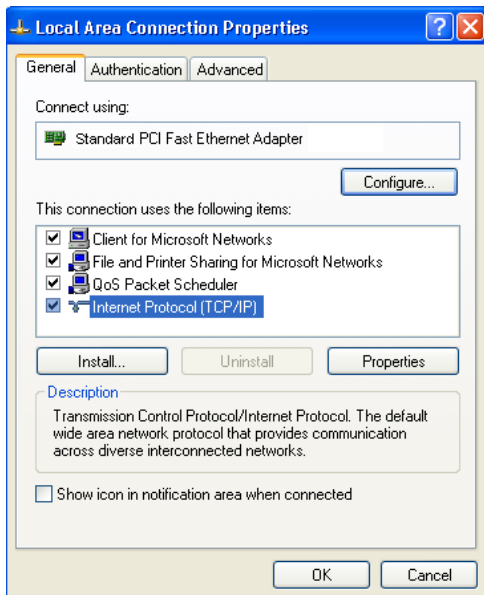

5. The **Internet Protocol TCP/IP Properties** window opens (the **General** tab in Windows XP).

-If you have a dynamic IP address click **Obtain an IP address automatically**.

-If you have a static IP address click **Use the following IP Address** and fill in the **IP address**, **Subnet mask**, and **Default gateway** fields.

Click **Advanced**.

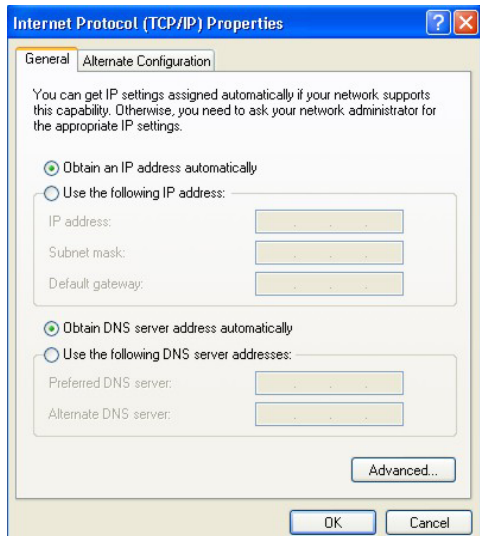

6. -If you do not know your gateway's IP address, remove any previously installed gateways in the **IP Settings** tab and click **OK**.

Do one or more of the following if you want to configure additional IP addresses:

-In the **IP Settings** tab, in IP addresses, click **Add**.

-In **TCP/IP Address**, type an IP address in **IP address** and a subnet mask in **Subnet mask**, and then click **Add**.

-Repeat the above two steps for each IP address you want to add.

-Configure additional default gateways in the **IP Settings** tab by clicking **Add** in **Default gateways**.

-In **TCP/IP Gateway Address**, type the IP address of the default gateway in **Gateway**. To manually configure a default metric (the number of transmission hops), clear the **Automatic metric** check box and type a metric in **Metric**.

-Click **Add**.

-Repeat the previous three steps for each default gateway you want to add.

-Click **OK** when finished.

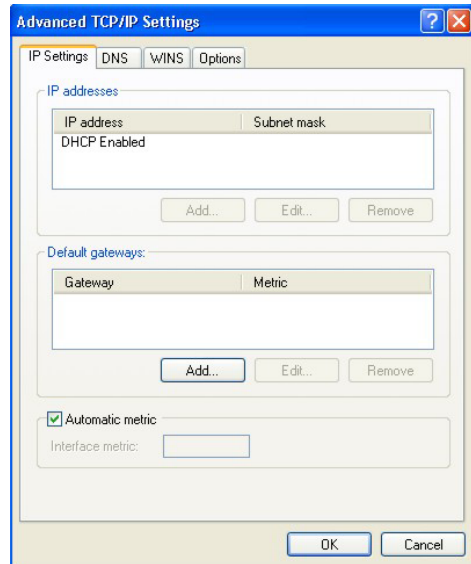

7. In the **Internet Protocol TCP/IP Properties** window (the **General tab** in Windows XP):

-Click **Obtain DNS server address automatically** if you do not know your DNS server IP address(es).

-If you know your DNS server IP address(es), click **Use the following DNS server addresses**, and type them in the **Preferred DNS server** and **Alternate DNS server** fields.

If you have previously configured DNS servers, click **Advanced** and then the **DNS** tab to order them.

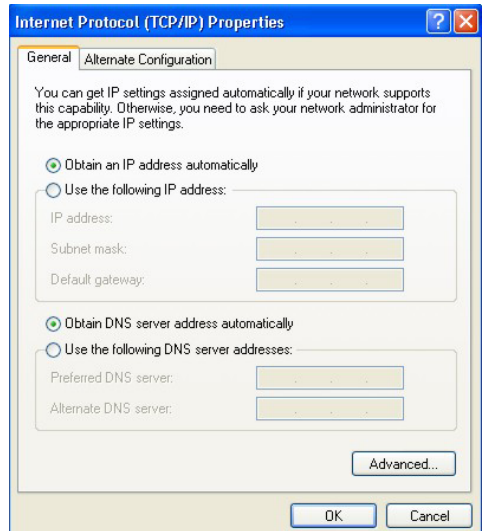

8. Click **OK** to close the **Internet Protocol (TCP/IP) Properties** window.
9. Click **OK** to close the **Local Area Connection Properties** window.
10. Turn on your Prestige and restart your computer (if prompted).

## Verifying Settings

1. Click **Start, All Programs, Accessories** and then **Command Prompt**.
2. In the **Command Prompt** window, type "ipconfig" and then press [ENTER]. You can also open **Network Connections**, right-click a network connection, click **Status** and then click the **Support** tab.



## Macintosh OS 8/9

1. Click the **Apple** menu, **Control Panel** and double-click **TCP/IP** to open the **TCP/IP Control Panel**.

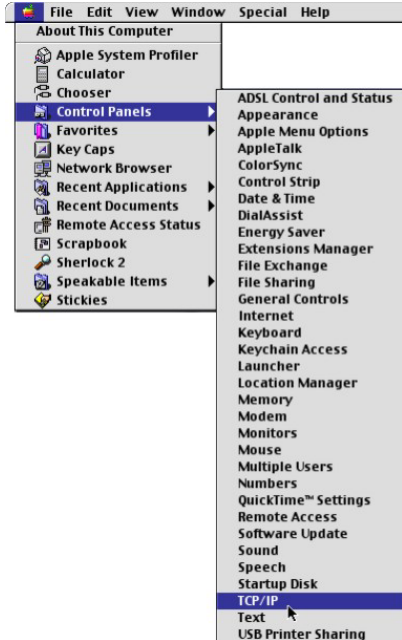

2. Select **Ethernet built-in** from the **Connect via** list.

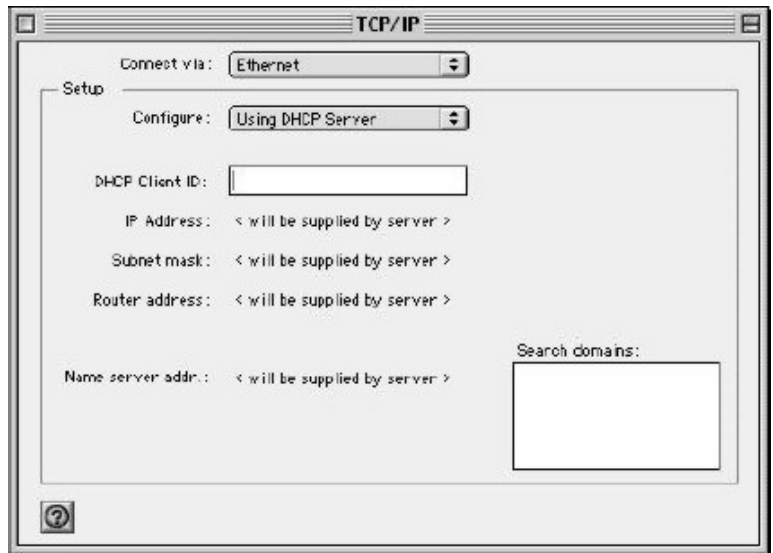

3. For dynamically assigned settings, select **Using DHCP Server** from the **Configure:** list.
4. For statically assigned settings, do the following:
  - From the **Configure** box, select **Manually**.
  - Type your IP address in the **IP Address** box.
  - Type your subnet mask in the **Subnet mask** box.
  - Type the IP address of your Prestige in the **Router address** box.
5. Close the **TCP/IP Control Panel**.
6. Click **Save** if prompted, to save changes to your configuration.
7. Turn on your Prestige and restart your computer (if prompted).

### Verifying Settings

Check your TCP/IP properties in the **TCP/IP Control Panel** window.

### Macintosh OS X

1. Click the **Apple** menu, and click **System Preferences** to open the **System Preferences** window.

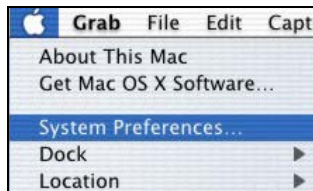

2. Click **Network** in the icon bar.
  - Select **Automatic** from the **Location** list.
  - Select **Built-in Ethernet** from the **Show** list.
  - Click the **TCP/IP** tab.

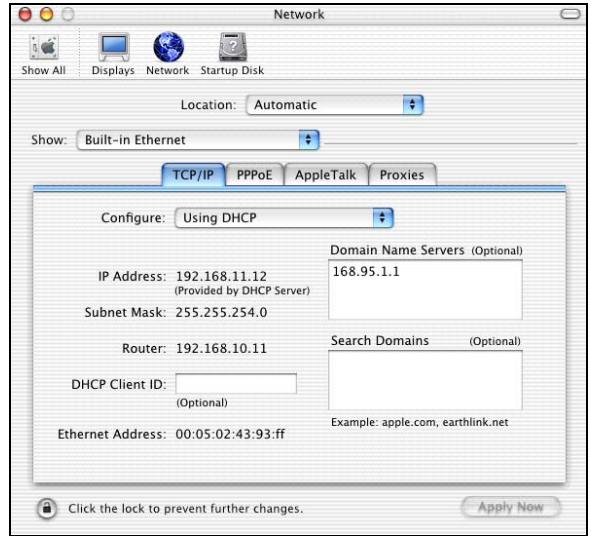

3. For dynamically assigned settings, select **Using DHCP** from the **Configure** list.
4. For statically assigned settings, do the following:
  - From the **Configure** box, select **Manually**.
  - Type your IP address in the **IP Address** box.
  - Type your subnet mask in the **Subnet mask** box.
  - Type the IP address of your Prestige in the **Router address** box.
5. Click **Apply Now** and close the window.
6. Turn on your Prestige and restart your computer (if prompted).

## Verifying Settings

Check your TCP/IP properties in the **Network** window.



# Appendix E

## Virtual Circuit Topology

ATM is a connection-oriented technology, meaning that it sets up virtual circuits over which end systems communicate. The terminology for virtual circuits is as follows:

- Virtual Channel                      Logical connections between ATM switches
- Virtual Path                          A bundle of virtual channels
- Virtual Circuit                        A series of virtual paths between circuit end points

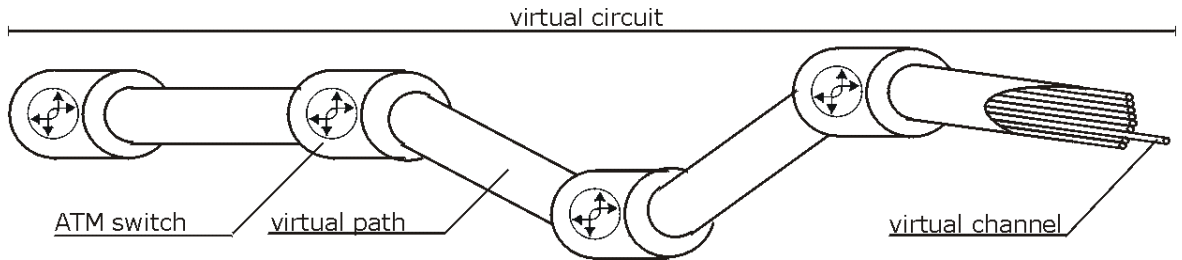

**Diagram E-1 Virtual Circuit Topology**

Think of a virtual path as a cable that contains a bundle of wires. The cable connects two points and wires within the cable provide individual circuits between the two points. In an ATM cell header, a VPI (Virtual Path Identifier) identifies a link formed by a virtual path; a VCI (Virtual Channel Identifier) identifies a channel within a virtual path.

The VPI and VCI identify a virtual path, that is, termination points between ATM switches. A series of virtual paths make up a virtual circuit.

Your service provider should supply you with VPI/VCI numbers.



# Appendix F

## Splitters and Microfilters

This appendix tells you how to install a POTS splitter or a telephone microfilter.

### Connecting a POTS Splitter

When you use the Full Rate (G.dmt) ADSL standard, you can use a POTS (Plain Old Telephone Service) splitter to separate the telephone and ADSL signals. This allows simultaneous Internet access and telephone service on the same line. A splitter also eliminates the destructive interference conditions caused by telephone sets.

Install the POTS splitter at the point where the telephone line enters your residence, as shown in the following figure.

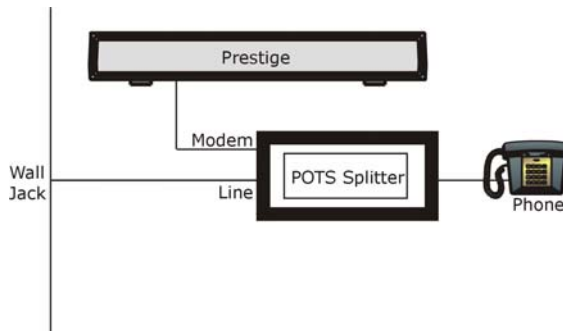

**Diagram F-1 Connecting a POTS Splitter**

- Step 1.** Connect the side labeled “Phone” to your telephone.
- Step 2.** Connect the side labeled “Modem” to your Prestige.
- Step 3.** Connect the side labeled “Line” to the telephone wall jack.

### Telephone Microfilters

Telephone voice transmissions take place in the lower frequency range, 0 - 4KHz, while ADSL transmissions take place in the higher bandwidth range, above 4KHz. A microfilter acts as a low-pass filter, for your telephone, to ensure that ADSL transmissions do not interfere with your telephone voice transmissions. The use of a telephone microfilter is optional.

- Step 1.** Connect a phone cable from the wall jack to the single jack end of the Y- Connector.

- Step 2.** Connect a cable from the double jack end of the Y-Connector to the “wall side” of the microfilter.
- Step 3.** Connect another cable from the double jack end of the Y-Connector to the Prestige.
- Step 4.** Connect the “phone side” of the microfilter to your telephone as shown in the following figure.

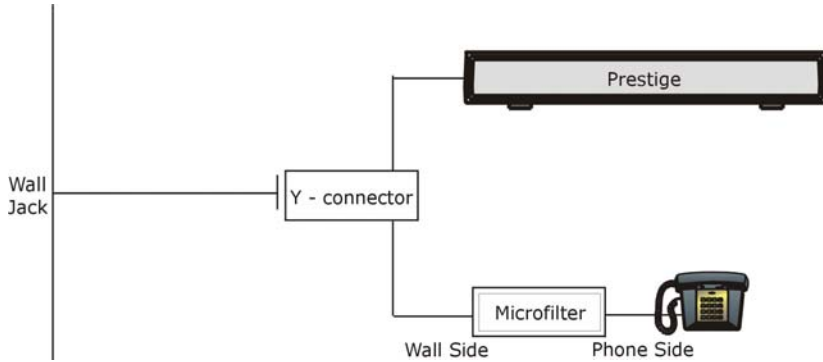

**Diagram F-2 Connecting a Microfilter**



# Appendix G

## Power Adaptor Specifications

<b>NORTH AMERICAN PLUG STANDARDS</b>	
AC Power Adapter Model	DV-1215A
Input Power	AC120Volts/60Hz/30W
Output Power	AC12Volts/1.25A
Power Consumption	11 W
Safety Standards	UL, CUL, CSA (UL 1310, CSA C22.2 No.223)
<b>NORTH AMERICAN PLUG STANDARDS</b>	
AC Power Adapter Model	AA-121A25
Input Power	AC120Volts/60Hz/19W
Output Power	AC 12Volts/ 1.25A
Power Consumption	11W
Safety Standards	UL, CUL (UL 1310, CSA C22.2 No.223)
<b>EUROPEAN PLUG STANDARDS</b>	
AC Power Adapter Model	AA-121A3BN
Input Power	AC230Volts/50Hz/140mA
Output Power	AC12Volts/1.3A
Power Consumption	11W
Safety Standards	ITS-GS, CE (EN 60950)



# Appendix H

## Index

### A

Address Assignment .....	4-2
ADSL, what is it? .....	xxii
Alternative Subnet Mask Notation .....	B-3
AT command .....	23-1
Authentication .....	16-4, 16-5

### B

Backup .....	23-2
Bridging .....	14-2
Ether Address .....	18-4
Ethernet .....	18-1
Ethernet Addr Timeout .....	18-3
Remote Node .....	18-1
Static Route Setup .....	18-3
Budget Management .....	24-2, 24-3

### C

Call Filtering .....	20-1
Call Filters	
Built-In .....	20-1
User-Defined .....	20-1
Call Scheduling .....	27-1
Maximum Number of Schedule Sets .....	27-1
PPPoE .....	27-3
Precedence .....	27-1
Precedence Example .....	<i>See precedence</i>
CDR .....	22-7
CDR (Call Detail Record) .....	22-6
CHAP .....	16-4
Classes of IP Addresses .....	B-1
Collision .....	22-3
Command Interpreter Mode .....	24-1
Community .....	21-2

Computer Name .....	13-1
Conditions that prevent TFTP and FTP from working over WAN .....	23-4
Configuration .....	3-12, 11-6
Copyright .....	ii
Cost Of Transmission .....	16-8, 17-3
Country Code .....	22-4
CPU Load .....	22-3
Customer Support .....	v

### D

Data Filtering .....	20-1
Device Filter rules .....	20-14
DHCP .....	3-12, 4-2, 7-1, 11-6, 22-4
Diagnostic Tools .....	22-1
DNS .....	14-3
Domain Name .....	4-2, 6-6
Domain Name System .....	4-1
DSL (Digital Subscriber Line) .....	xxii
DSLAM .....	<i>See Digital Subscriber Line Access     Multiplexer</i>
Dynamic DNS .....	7-1, 13-2
DYNDNS Wildcard .....	7-1

### E

ECHO .....	6-6
Encapsulation .....	1-2, 3-1, 15-5, 16-2
ENET ENCAP .....	3-1
PPP over Ethernet .....	3-1
PPPoA .....	3-1
RFC 1483 .....	3-2
Error Log .....	22-5
Error/Information Messages	
Sample .....	22-6
Ethernet Encapsulation .....	6-5

Ethernet Traffic..... 20-18

**F**

Factory LAN Defaults ..... 4-2

FCC..... iii

Filename Conventions ..... 23-1

Filter ..... 14-1

    Applying Filters..... 20-17

    Ethernet traffic..... 20-18

    Ethernet Traffic ..... 20-18

    Filter log ..... 22-7

    Filter Rules ..... 20-6

    Filter Structure..... 20-4

    Generic Filter Rule ..... 20-12

    Remote Node..... 16-9

    Remote Node Filter ..... 16-9

    Remote Node Filters..... 20-18

    Sample..... 20-16

    SUA..... 20-14

    TCP/IP Filter Rule..... 20-8

Filter log ..... 22-8

Filter Rule..... 20-9

Filter Rule Process..... 20-3

Filter Rule Setup..... 20-7

Filter Rules Summary

    Sample..... 20-17

Filter Set

    Class..... 20-8

Filter Set Configuration ..... 20-4

Filtering ..... 20-1, 20-8

Filtering Process

    Outgoing Packets..... 20-2

Finger..... 6-6

Firmware File

    Maintenance ..... 11-10

Forgot My Login Password ..... A-3

Frame Relay..... 1-3

FTP ..... 6-5, 6-6, 7-1, 9-1, 25-2

    Restrictions..... 25-2

FTP File Transfer..... 23-8

FTP Restrictions ..... 9-1, 23-4

FTP Server..... 19-15

Full Rate ..... F-1

**G**

Gateway..... 17-3

Gateway Node ..... 18-4

General Setup ..... 13-1

**H**

Hidden Menus ..... 12-3

Hop Count ..... 16-8, 17-3

Host ..... 2-3

Host IDs..... B-1

HTTP..... 6-6

**I**

IANA ..... 3-5

IGMP..... 4-3

IGMP support..... 16-8

Install UPnP..... 10-3

    Windows Me ..... 10-3

    Windows XP ..... 10-4

Interactive Applications..... 26-1

Internet access ..... 15-1

Internet Access ..... 1-1, 1-3, 1-4, 14-2, 15-1, 15-5

Internet Access Setup ..... A-5, 19-1

Internet Assigned Numbers Authority...*See* IANA

Introduction to DSL..... xxii

IP Address3-4, 4-3, 6-5, 6-8, 11-6, 14-3, 17-3, 18-4, 20-9, 22-4, 22-9, 26-3

IP Address Assignment ..... 3-4

    ENET ENCAP ..... 3-5

    PPPoA or PPPoE..... 3-5

    RFC 1483 ..... 3-5

IP Addressing ..... B-1

IP Alias Setup..... 15-2

IP Classes ..... B-1

IP Filter..... 20-11

    Logic Flow ..... 20-10

IP mask..... 20-9

IP Packet..... 20-12

IP Policies .....	26-5
IP Policy Routing (IPPR).....	1-2, 15-1
Applying an IP Policy.....	26-5
Ethernet IP Policies.....	26-5
Gateway.....	26-5
IP Pool Setup.....	3-13
IP Protocol .....	26-4
IP Routing Policy (IPPR).....	26-1
Benefits.....	26-1
Cost Savings.....	26-1
Criteria.....	26-1
Load Sharing.....	26-1
Setup.....	26-2
IP Routing Policy Setup.....	26-3
IP Static Route .....	17-1
IP Static Route Setup .....	17-2

**L**

LAN .....	22-2, 22-3
LAN Setup .....	4-1, 5-1
LAN TCP/IP .....	4-2
Link type .....	22-2
LLC-based Multiplexing.....	16-13
Log and Trace .....	22-6
Log Facility.....	22-7
Logging Option.....	20-10, 20-13
Login.....	16-4

**M**

MAC address .....	18-4
Main Menu.....	12-3
Management Information Base (MIB).....	21-2
MBS.....	<i>See</i> Maximum Burst Size
Media Access Control.....	18-1
Message Logging.....	22-5
Metric.....	16-5, 16-8, 17-3
Multicast .....	4-3, 16-8
Multiplexing	
LLC-based .....	3-2
VC-based .....	3-2
Multiplexing.....	1-2, 3-2, 15-6, 16-2

Multiprotocol Encapsulation.....	3-2
My WAN Address.....	16-7

**N**

Nailed-Up Connection.....	3-6
NAT .....	3-4, 6-5, 6-7, 20-14
Application .....	6-2
Applying NAT in the SMT Menus.....	19-1
Configuring .....	19-3
Definitions.....	6-1
Examples .....	19-11
How NAT Works .....	6-2
Mapping Types.....	6-3
Non NAT Friendly Application Programs	19-17
Ordering Rules .....	19-6
Server Sets.....	6-5
What NAT does.....	6-1
NAT Traversal.....	10-1
Network Address Translation (NAT) .....	1-3, 19-1
Network Management .....	6-6
NNTP.....	6-6

**P**

Packet	
Error .....	22-2
Received.....	22-3
Transmitted.....	22-2
Packet triggered .....	22-7
Packets .....	22-2
PAP.....	16-4
Password.....	2-3, 12-1, 12-5, 16-4, 21-2
Ping.....	22-9
Point-to-Point.....	xxii
Point-to-Point Tunneling Protocol..	6-6. <i>See</i> PPTP
policy-based routing .....	26-1
POP3 .....	6-6
Port Numbers .....	6-6
PPP Encapsulation.....	16-13
PPP log .....	22-7, 22-8
PPPoA.....	16-2
PPTP.....	6-6

Precedence ..... 26-1, 26-4  
 Private ..... 16-8, 17-4  
 Protocol ..... 20-9  
 Protocol Filter Rules ..... 20-14

**Q**

Quality of Service ..... 26-1  
 Quick Start Guide ..... 2-1

**R**

RAS ..... 22-4, 26-2  
 Rate  
     Receiving ..... 22-2  
     Transmission ..... 22-2  
 Related Documentation ..... xx  
 Remote DHCP Server ..... 14-3  
 Remote Management and NAT ..... 9-2  
 Remote Management Limitations ..... 9-1, 25-2  
 Remote Management Setup ..... 25-1  
 Remote Node ..... 16-1, 22-2  
     Remote Node Profile ..... 16-3  
     Remote Node Setup ..... 16-1, 16-2  
 Remote Node Index Number ..... 22-2  
 Remote Node Traffic ..... 20-19  
 Required fields ..... 12-3  
 Restore Configuration ..... 23-6  
 RFC-1483 ..... 16-2  
 RFC-2364 ..... 16-2, 16-3  
 RIP.14-3, 16-8. *See* Routing Information Protocol  
 Routing Information Protocol ..... 4-3  
     Direction ..... 4-3  
     Version ..... 4-3  
 Routing Policy ..... 26-1

**S**

Sample IP Addresses ..... 16-9  
 Schedule Sets  
     Duration ..... 27-2  
 SCR ..... *See* Sustain Cell Rate  
 Security ..... 1-3

Server 6-4, 8-2, 19-4, 19-5, 19-8, 19-9, 19-10, 19-13, 19-14, 24-5  
 Service ..... iv  
 Service Type ..... A-5  
 Services ..... 6-5, 6-6  
     setup a schedule ..... 27-2  
 Single User Account ..... 15-7  
 SMT Menu Overview ..... 12-1  
 SMTP ..... 6-6  
 SNMP ..... 6-6  
     Community ..... 21-3  
     Configuration ..... 21-2  
     Get ..... 21-2  
     Manager ..... 21-2  
     MIBs ..... 21-2  
     Trap ..... 21-2  
     Trusted Host ..... 21-3  
 SNMP ( Simple Network Management Protocol)  
     ..... 1-2  
 Source-Based Routing ..... 26-1  
 Splitters ..... F-1  
 Static Route Setup ..... 17-1  
 Static Routing Topology ..... 17-1  
 SUA ..... 6-5, 6-6  
 SUA (Single User Account) ... *See* NAT. *See* NAT  
 Subnet Mask ..... 3-4, 4-3, 14-3, 16-7, 17-3, 22-4  
 Subnet Masks ..... B-2  
 Subnetting ..... B-2  
 Supporting Disk ..... xx  
 Syntax Conventions ..... xx  
 Syslog ..... 22-6  
 Syslog IP Address ..... 22-6  
 Syslog Server ..... 22-6  
 System  
     Console Port Speed ..... 22-5  
     Diagnostic ..... 22-8  
     Log and Trace ..... 22-5  
     Syslog and Accounting ..... 22-6  
     System Information ..... 22-3  
     System Status ..... 22-1  
     System Information ..... 22-3

System Information & Diagnosis .....	22-1
System Maintenance ...	22-1, 22-3, 23-2, 23-5, 23-11, 24-1, 24-2, 24-4, 24-5
System Management Terminal .....	12-3
System Status .....	22-2
System Timeout .....	9-2, 25-3

**T**

TCP/IP .....	9-2, 20-14, 22-9
Telephone Microfilters.....	F-1
Telnet .....	9-2
Telnet Configuration .....	9-2
TFTP	
And FTP Over WAN} .....	25-2
Restrictions .....	25-2
TFTP and FTP over WAN Will Not Work	
When .....	23-4
TFTP and FTP Over WAN} .....	9-1
TFTP File Transfer.....	23-10
TFTP Restrictions .....	9-1, 23-4
Time and Date Setting.....	24-3, 24-4, 24-5
Time Zone.....	24-5
TOS (Type of Service).....	26-1
Trace Records .....	22-5
Transmission Rates .....	1-1
Troubleshooting	
Internet Browser Display .....	A-3
Login Password .....	A-3
Power LED .....	A-1, A-2
Telnet .....	A-2

Web Configurator .....	A-3
Type of Service .....	26-1, 26-3, 26-4, 26-5

**U**

Universal Plug and Play.....	10-1
Application .....	10-1
Security issues .....	10-1
Universal Plug and Play Forum .....	10-2
UNIX Syslog .....	22-5, 22-6
UNIX syslog parameters.....	22-6
Upload Firmware .....	23-8
UPnP.....	<i>See</i> Universal Plug and Play
User Name .....	7-2
Using LEDs To Diagnose Problems .....	A-1

**V**

VC-based Multiplexing .....	16-2
VPI & VCI.....	3-2
VPN .....	5-1

**W**

Web Configurator .....	2-1, 2-2
Wizard Setup .....	3-1

**Z**

ZyNOS.....	23-1, 23-2
ZyNOS F/W Version .....	23-1
ZyXEL Limited Warranty	
Note.....	iv